

### **Event Data Recorders**

Your vehicle is equipped with several devices commonly referred to as Event Data Recorders. They record various types of real time vehicle data such as SRS airbag deployment and SRS system components failure.

This data belongs to the vehicle owner and may not be accessed by anyone else except as legally required or with the permission of the vehicle owner.

However this data may be accessed by Honda, its authorised dealers and authorised repairers, employees, representatives and contractors only for the purpose of the technical diagnosis, research and development of the vehicle.

### **Service Diagnostic Recorders**

Your vehicle is equipped with service-related devices that record information about powertrain performance and driving conditions. The data can be used to help technicians diagnose, repair and maintain the vehicle. This data may not be accessed by anyone else except as legally required or with the permission of the vehicle owner.

However this data may be accessed by Honda, its authorised dealers and authorised repairers, employees, representatives and contractors only for the purpose of the technical diagnosis, research and development of the vehicle.

This owner's manual should be considered a permanent part of the vehicle and should remain with the vehicle when it is sold.

This owner's manual covers all models of your vehicle. You may find descriptions of equipment and features that are not on your particular model.

Images throughout this owner's manual represent features and equipment that are available on some, but not all, models. Your particular model may not have some of these features.

The information and specifications included in this publication were in effect at the time of approval for printing. Honda Motor Co., Ltd. reserves the right, however, to discontinue or change specifications or design at any time without notice and without incurring any obligation.

Although this manual is applicable to both right-hand and left-hand drive models, the illustrations contained in this manual mainly refer to the left-hand drive models.

#### ➤ Safe Driving P. 41

For Safe Driving P. 42      Seat Belts P. 46      Airbags P. 58  
Safety Labels P. 105

#### ➤ Instrument Panel P. 107

Indicators P. 108      Gauges and Driver Information Interface P. 159

#### ➤ Controls P. 185

Lock P. 186      Locking and Unlocking the Doors P. 188  
Sunroof\* P. 216  
Adjusting the Seats P. 243      Interior Lights/Interior Convenience Items P. 252

#### ➤ Features P. 283

Audio System\* P. 284      Audio System Basic Operation P. 290, 315  
Customized Features P. 388, 396

#### ➤ Driving P. 483

Before Driving P. 484      Towing a Trailer P. 488  
Parking Your Vehicle P. 642      Multi-View Rear Camera\* P. 653  
Turbo Engine Vehicle P. 660

#### ➤ Maintenance P. 661

Before Performing Maintenance P. 662      Service Reminder System\* P. 665  
Maintenance Under the Bonnet P. 682      Replacing Light Bulbs P. 702  
Battery P. 722      Remote Transmitter Care P. 727  
Accessories and Modifications P. 738

#### ➤ Handling the Unexpected P. 741

Tools P. 742      If a Tyre Goes Flat P. 744  
Shift Lever Does Not Move P. 776      Overheating P. 779  
If You Cannot Unlock the Fuel Fill Door P. 800

#### ➤ Information P. 803

Specifications P. 804      Identification Numbers P. 808

# Contents

Quick Reference Guide P. 4

Safe Driving P. 41

Instrument Panel P. 107

Controls P. 185

Features P. 283

Driving P. 483

Maintenance P. 661

Handling the Unexpected P. 741

Information P. 803

Index P. 828

Pop-up Hood System\* P. 71

Child Safety P. 74

Exhaust Gas Hazard P. 104

Hatch P. 204

Security System P. 207

Opening and Closing the Windows P. 212

Operating the Switches Around the Steering Wheel P. 218

Adjusting the Mirrors P. 240

Heating System\* P. 270

Climate Control System\* P. 275

Audio Error Messages P. 380

General Information on the Audio System P. 382

Hands-Free Telephone System P. 430, 451

When Driving P. 493

Honda Sensing\* P. 562

Braking P. 633

Refueling P. 655

Fuel Economy and CO<sub>2</sub> Emissions P. 659

Oil Monitor System\* P. 670

Maintenance Schedule\* P. 674

Checking and Maintaining Wiper Blades P. 711

Checking and Maintaining Tyres P. 716

Heating System\*/Climate Control System\* Maintenance P. 729

Cleaning P. 732

Handling of the Jack P. 767

Engine Does Not Start P. 768

If the Battery Is Dead P. 772

Indicator, Coming On/Blinking P. 782

Fuses P. 790

Emergency Towing P. 797

If You Cannot Open the Hatch P. 801

Refueling P. 802

Devices that Emit Radio Waves\* P. 811

EC Declaration of Conformity Content Outline\* P. 824

# Visual Index

Left-hand Drive Type

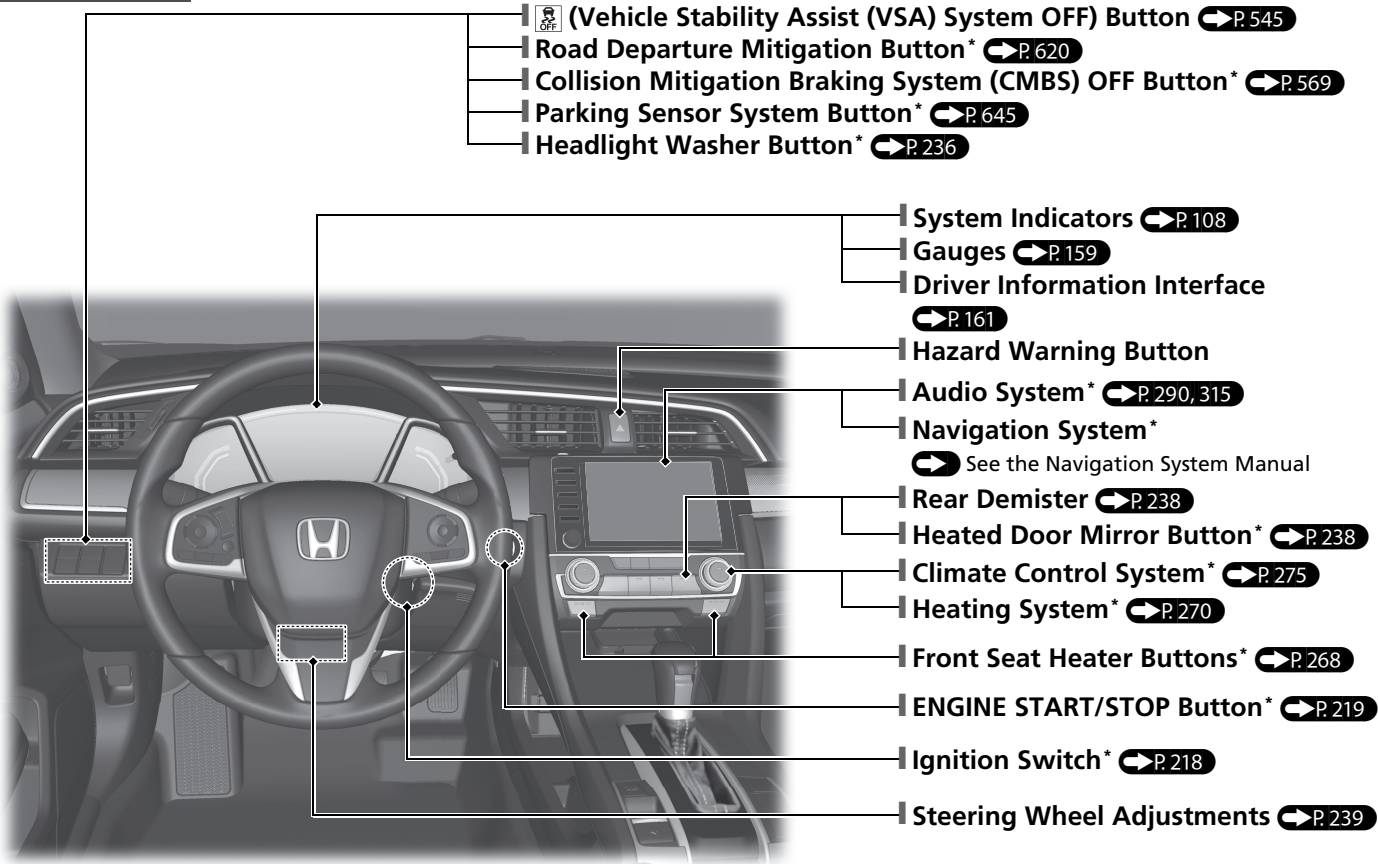

(Vehicle Stability Assist (VSA) System OFF) Button ➔ P. 545

Road Departure Mitigation Button\* ➔ P. 620

Collision Mitigation Braking System (CMBS) OFF Button\* ➔ P. 569

Parking Sensor System Button\* ➔ P. 645

Headlight Washer Button\* ➔ P. 236

System Indicators ➔ P. 108

Gauges ➔ P. 159

Driver Information Interface  
➔ P. 161

Hazard Warning Button

Audio System\* ➔ P. 290, 315

Navigation System\*  
➔ See the Navigation System Manual

Rear Demister ➔ P. 238

Heated Door Mirror Button\* ➔ P. 238

Climate Control System\* ➔ P. 275

Heating System\* ➔ P. 270

Front Seat Heater Buttons\* ➔ P. 268

ENGINE START/STOP Button\* ➔ P. 219

Ignition Switch\* ➔ P. 218

Steering Wheel Adjustments ➔ P. 239

Right-hand Drive Type

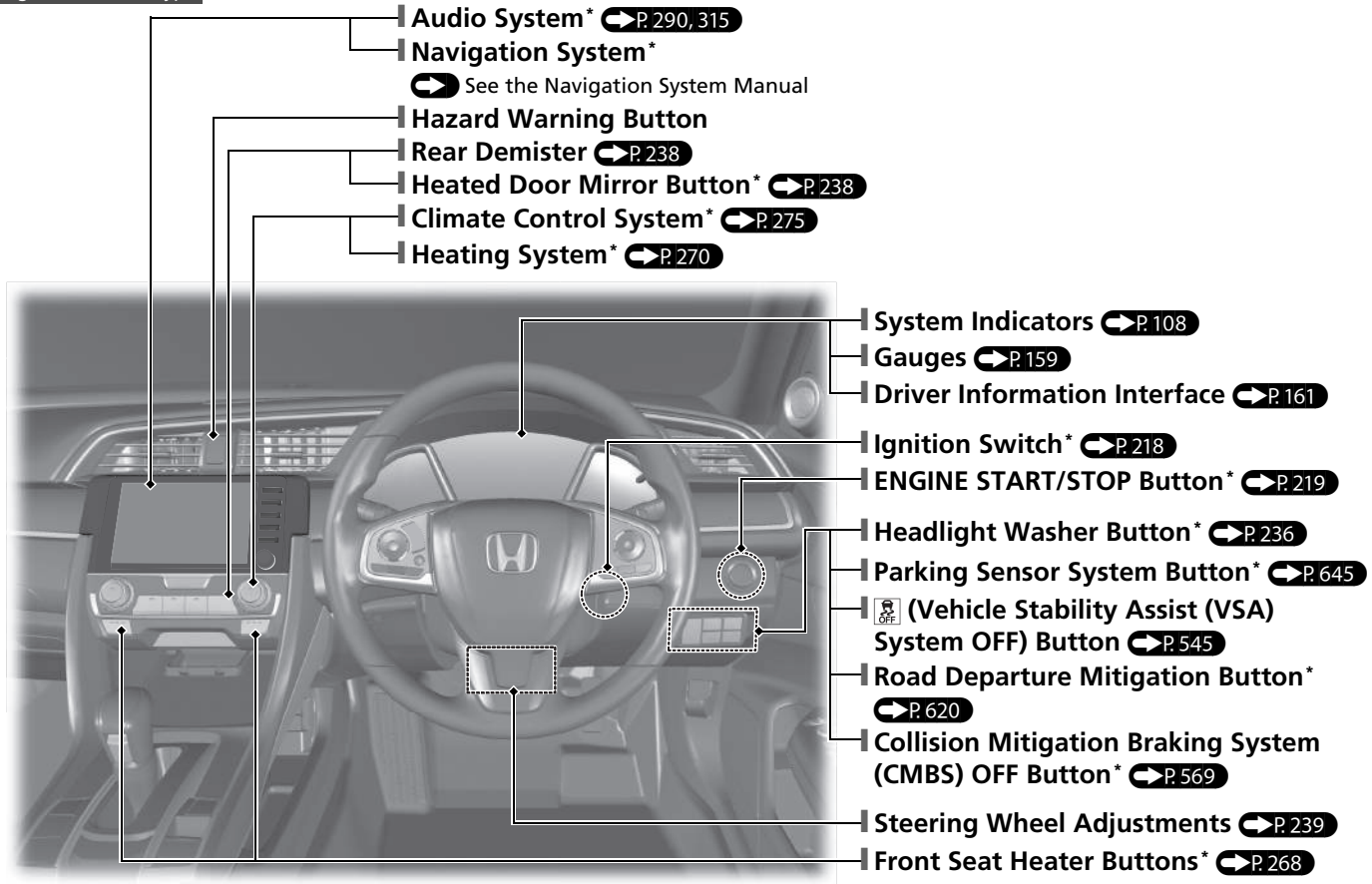

\* Not available on all models

# Visual Index

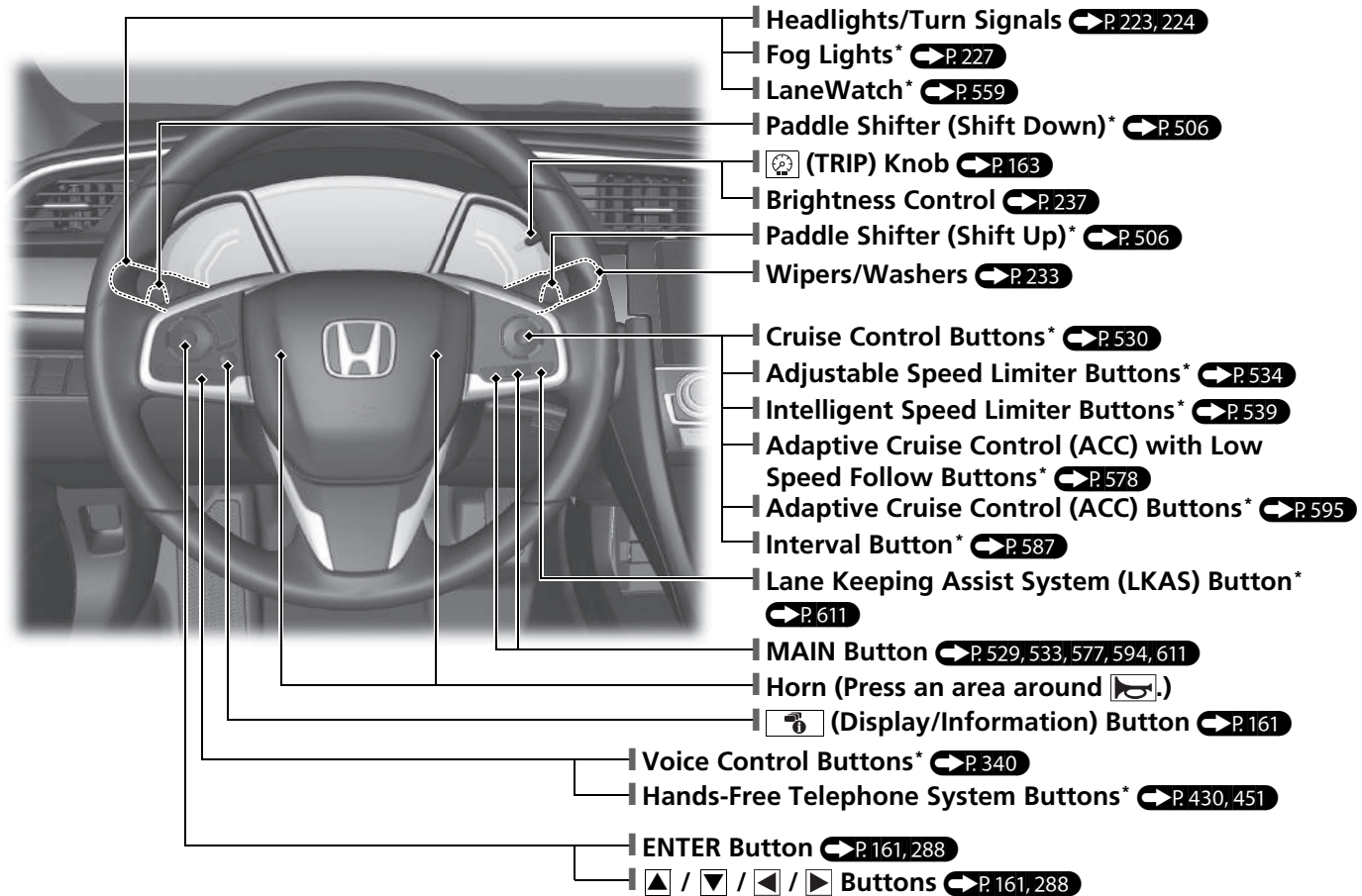

Left-hand Drive Type

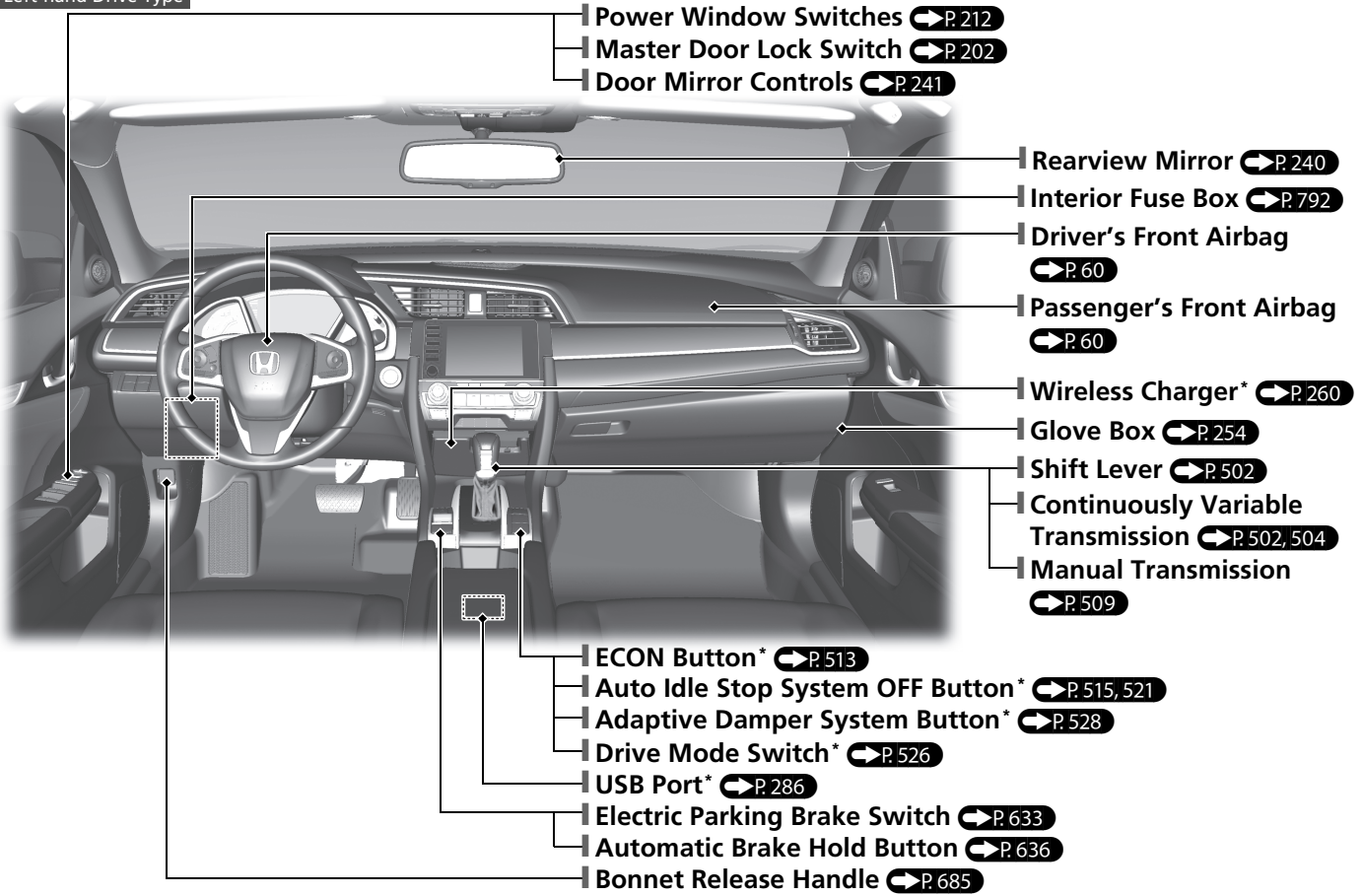

\* Not available on all models

# Visual Index

Right-hand Drive Type

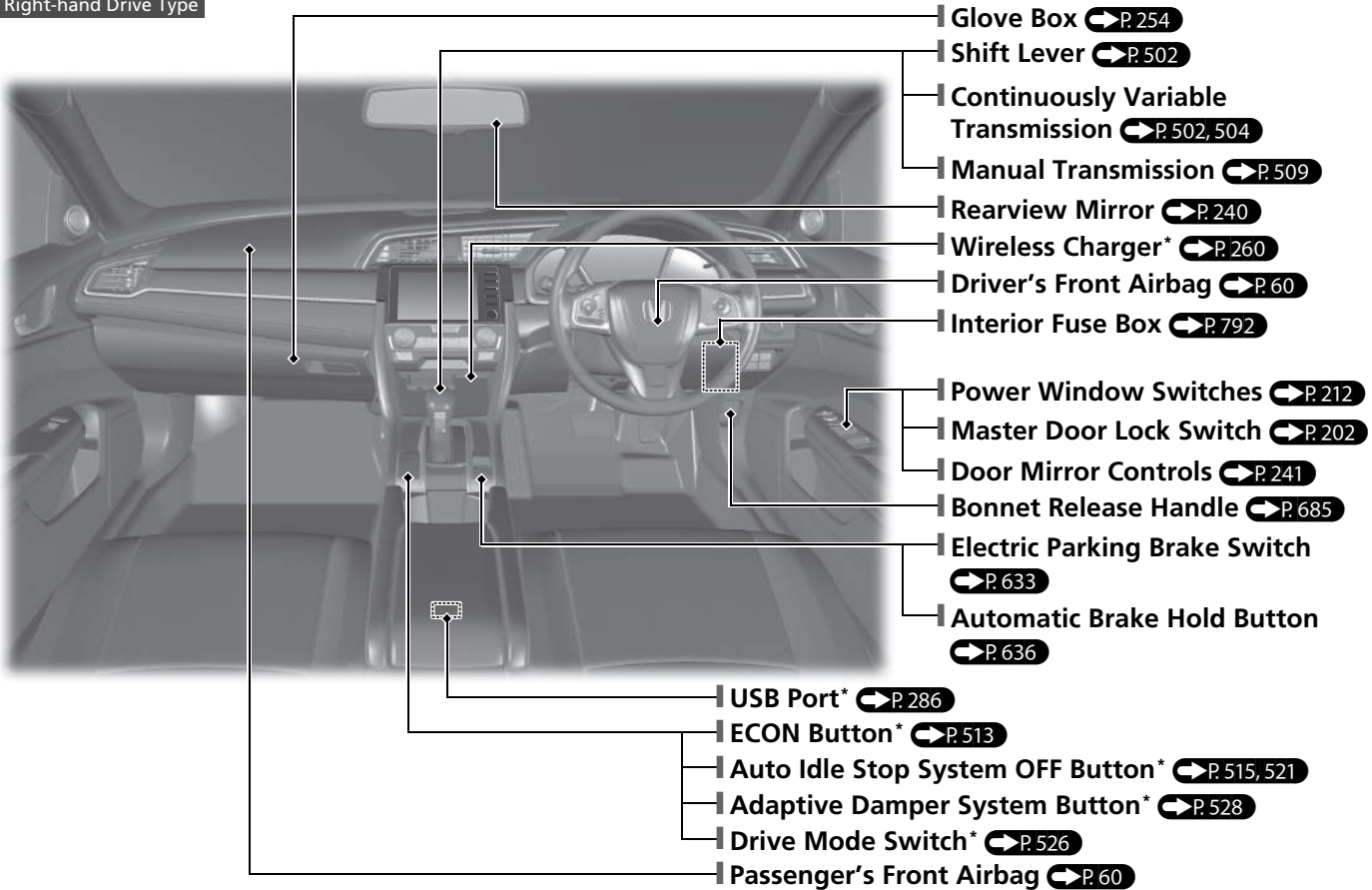



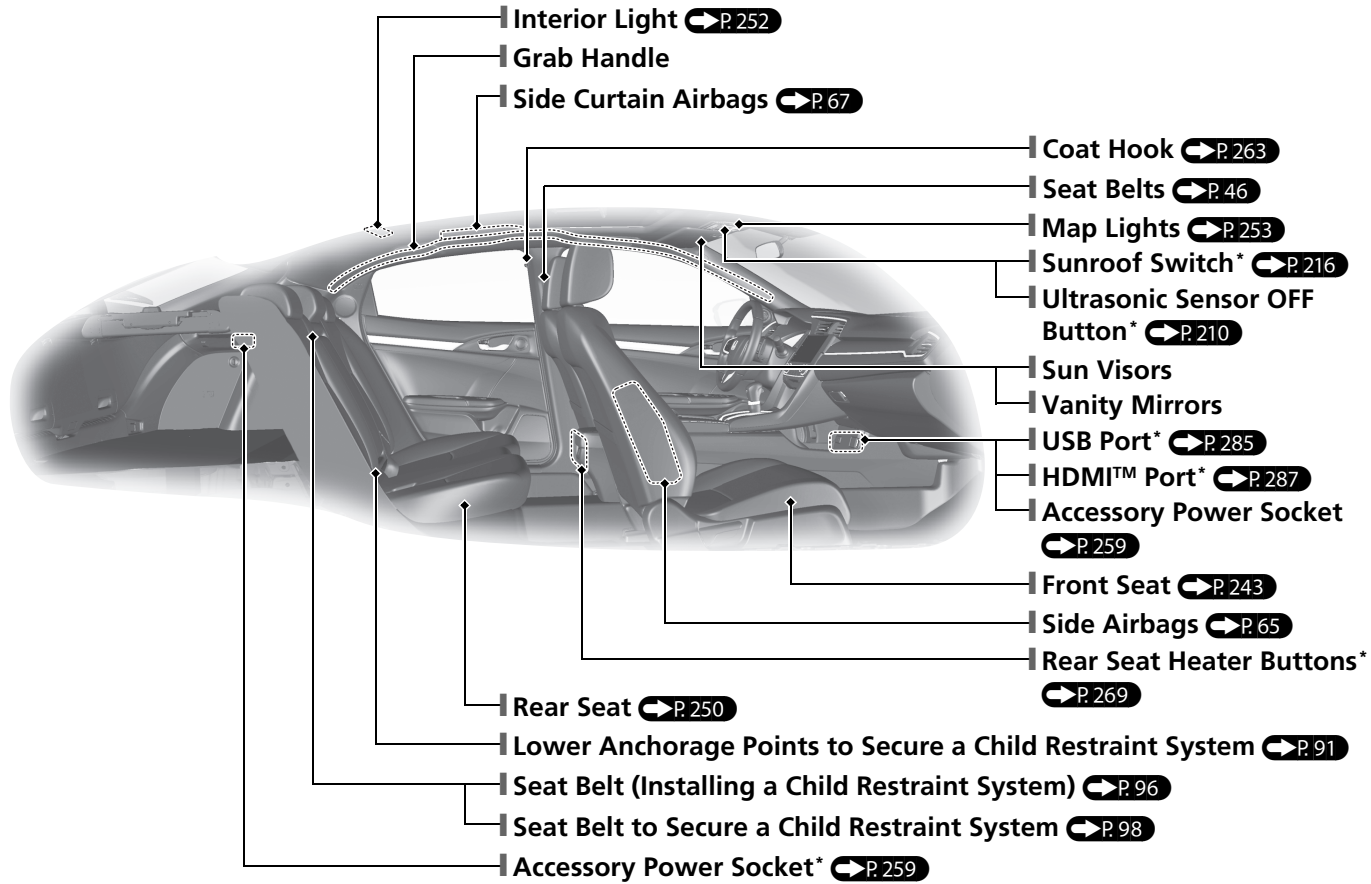

\* Not available on all models

# Visual Index

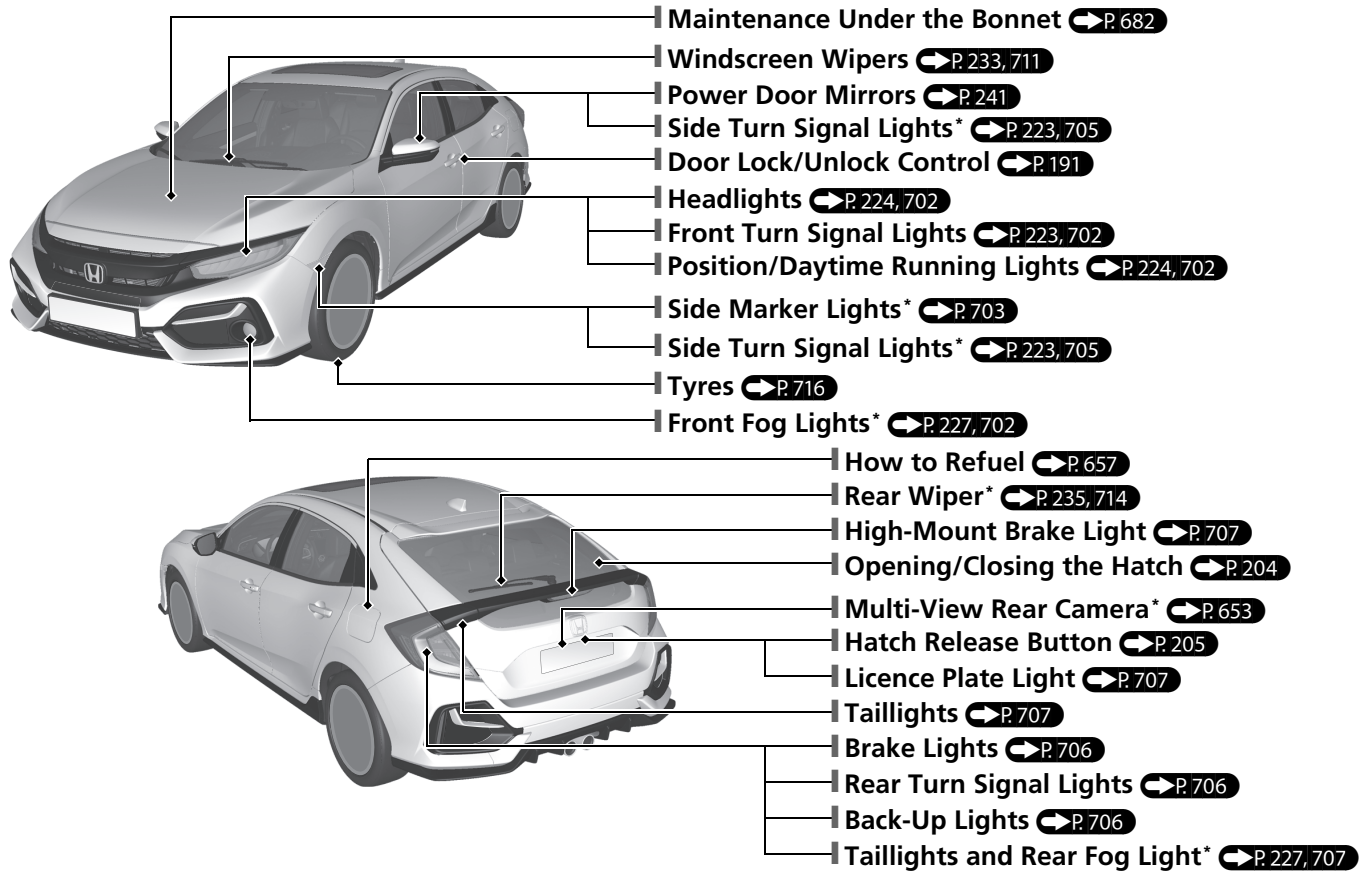

# Eco Assist System

Except 2.0 L engine models

## Ambient Meter

- The colour of the ambient meter changes to green to indicate that the vehicle is being driven in a fuel efficient manner.

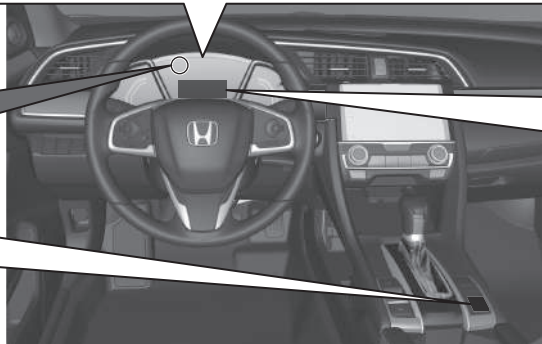

**ECON Button**  **P.513**  
Helps to maximise fuel economy.



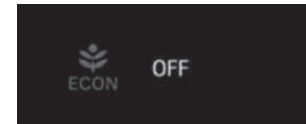
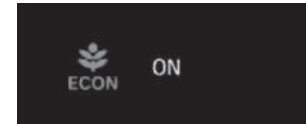



**ECON Mode Indicator**  **P.123**  
Comes on when the ECON button is pressed.



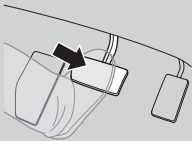

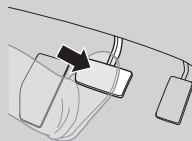
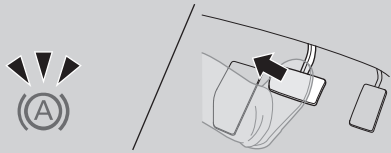
The message is displayed for a few seconds when the ECON button is pressed.

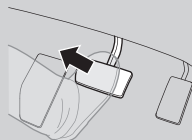
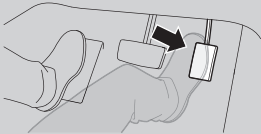
# Auto Idle Stop Function\*

To improve fuel economy, the engine stops and then restarts as detailed below. When Auto Idle Stop is on, the Auto Idle Stop indicator (green) comes on.  P.514, 520

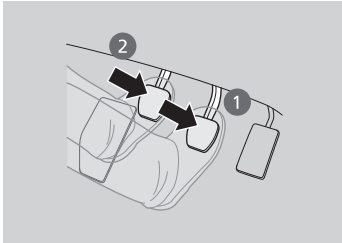
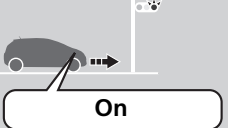
At	Continuously variable transmission	Engine status
Deceleration  	 Stop the vehicle and depress the brake pedal.	 <b>On</b>
Stop  	 <p>Keep the brake pedal depressed.</p>  <p>With the automatic brake hold system activated, you can release the brake pedal when the (A) indicator comes on.</p>	 <b>Off</b>
Start-up	 <p>Release the brake pedal.</p>  <p>With the automatic brake hold system activated, depress the accelerator pedal.</p>	 <b>Restarting</b>

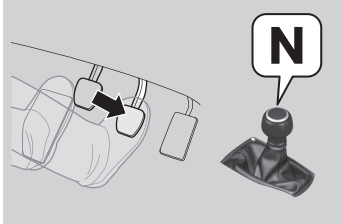
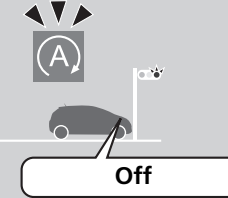
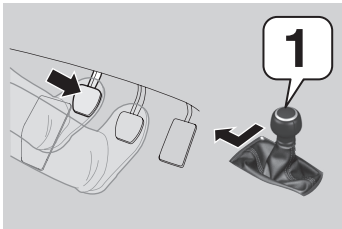
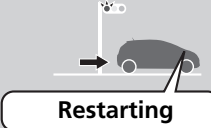
At	Manual transmission	Engine status
<p>Deceleration</p> 	<p>1. Depress the brake pedal. 2. Fully depress the clutch pedal.</p> 	 <p>On</p>
<p>Stop</p> 	<ul style="list-style-type: none"> <li>• Continue to depress the brake pedal.</li> <li>• Move the shift lever to <b>N</b>.</li> <li>• Release the clutch pedal.</li> </ul> 	 <p>Off</p>
<p>Start-up</p>	<p>1. Depress the clutch pedal again. 2. Move the shift lever to <b>1</b>. 3. Depress the accelerator pedal to resume driving.</p> 	 <p>Restarting</p>

\* Not available on all models

# Safe Driving ➔ P.41

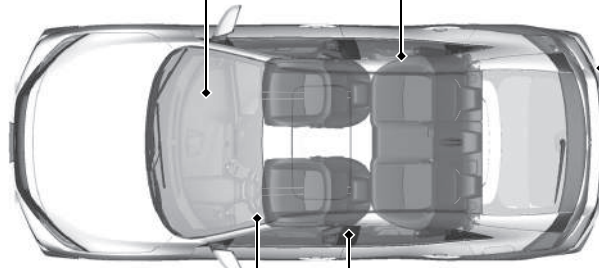

**Airbags** ➔ P.58

- Your vehicle is fitted with airbags to help to protect you and your passengers during a moderate-to-severe collision.

**Child Safety** ➔ P.74

- All children 12 and younger should be seated in the rear seat.
- Small children should be properly restrained in a front-facing child restraint system.
- Infants must be properly restrained in a rear-facing child restraint system on a rear seat.

**Exhaust Gas Hazard** ➔ P.104

- Your vehicle emits dangerous exhaust gases that contain carbon monoxide. Do not run the engine in confined spaces where carbon monoxide gas can accumulate.

**Seat Belts** ➔ P.46

- Fasten your seat belt and sit upright well back in the seat.
- Check that your passengers are wearing their seat belts correctly.

**Before Driving Checklist** ➔ P.45

- Before driving, check that the front seats, head restraints\*, steering wheel, and mirrors have been properly adjusted.













Fasten your lap belt as low as possible.

# Instrument Panel P.107

## Gauges P.159 / Driver Information Interface P.161 / System Indicators P.108

Except 2.0 L engine models

### System Indicators

-  ECON Mode Indicator
-  Seat Belt Reminder Indicator
-  Vehicle Stability Assist (VSA) System Indicator
-  VSA OFF Indicator
-  Supplemental Restraint System Indicator
-  Auto Idle Stop System Indicator (Amber) / Auto Idle Stop Indicator (Green)\*
-  Low Tyre Pressure/Deflation Warning System Indicator
-  Electric Power Steering (EPS) System Indicator
-  Malfunction Indicator Lamp
-  Low Oil Pressure Indicator
-  Charging System Indicator

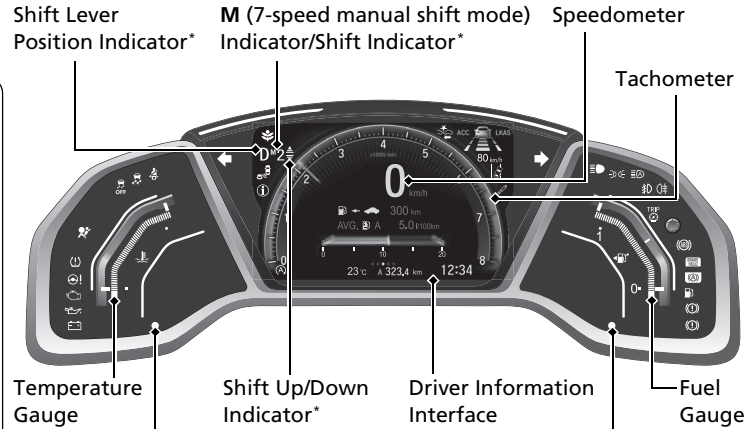



**Left-hand Drive Type**

Immobilizer System Indicator/Security System Alarm Indicator



**Right-hand Drive Type**

Immobilizer System Indicator/Security System Alarm Indicator













### System Indicators

- ACC** Adaptive Cruise Control (ACC) with Low Speed Follow\* Indicator (Amber/Green)\*
-  Blind spot information System Indicator\*
-  System Message Indicator

### System Indicators

- LKAS** Lane Keeping Assist System (LKAS) Indicator (Amber/Green)\*
-  Road Departure Mitigation Indicator\*
-  Collision Mitigation Braking System (CMBS) Indicator\*











### System Indicators

-  Turn Signal and Hazard Warning Indicators
-  Adaptive Damper System Indicator\*
-  High Beam Indicator
-  Lights On Indicator
-  Auto High-Beam Indicator\*
-  Front Fog Light Indicator\*
-  Rear Fog Light Indicator
-  Anti-lock Brake System (ABS) Indicator
-  Automatic Brake Hold System Indicator
-  Automatic Brake Hold Indicator
-  Low Fuel Indicator
-  Parking Brake and Brake System Indicator (Red)
-  Parking Brake and Brake System Indicator (Amber)

\* Not available on all models

2.0 L engine models

System Indicators

-  Seat Belt Reminder Indicator
-  Vehicle Stability Assist (VSA) System Indicator
-  VSA OFF Indicator
-  Supplemental Restraint System Indicator
-  Auto Idle Stop System Indicator (Amber)\* / Auto Idle Stop Indicator (Green)\*
-  Low Tyre Pressure/Deflation Warning System Indicator
-  Electric Power Steering (EPS) System Indicator
-  Malfunction Indicator Lamp
-  Low Oil Pressure Indicator
-  Charging System Indicator

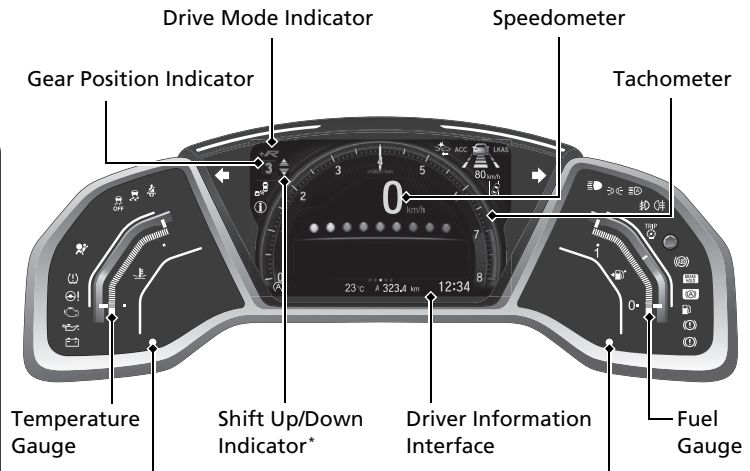



Left-hand Drive Type

-  Immobilizer System Indicator/Security System Alarm Indicator



Right-hand Drive Type

-  Immobilizer System Indicator/Security System Alarm Indicator













System Indicators

-  **ACC** Adaptive Cruise Control (ACC) Indicator (Amber/Green)\*
-  Blind spot information System Indicator\*
-  System Message Indicator

System Indicators

-  **LKAS** Lane Keeping Assist System (LKAS) Indicator (Amber/Green)\*
-  Road Departure Mitigation Indicator\*
-  Collision Mitigation Braking System (CMBS) Indicator\*

System Indicators

-  Turn Signal and Hazard Warning Indicators
-  High Beam Indicator
-  Lights On Indicator
-  Auto High-Beam Indicator\*
-  Front Fog Light Indicator
-  Rear Fog Light Indicator\*
-  Anti-lock Brake System (ABS) Indicator
-  Automatic Brake Hold System Indicator
-  Automatic Brake Hold Indicator
-  Low Fuel Indicator
-  Parking Brake and Brake System Indicator (Red)
-  Parking Brake and Brake System Indicator (Amber)





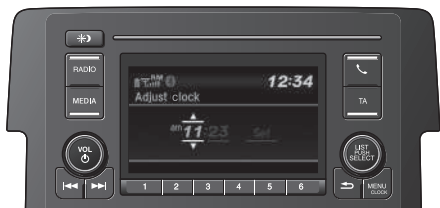

# Controls P.185

## Clock P.186

### Models with colour audio system





- 1 Press and hold the **MENU/CLOCK** button.
- 2 Rotate  to change hour, then press .
- 3 Rotate  to change minute, then press .
- 4 Select **Set**, then press .

These indications are used to show how to operate the selector knob.

- Rotate  to select.
- Press  to enter.

### Models with Display Audio











- 1 Press the  (Home) button, then select **Settings**.
- 2 Select **Clock**, then **Clock Adjustment**.
- 3 Touch the respective  /  icon to adjust the hours or minutes up or down.
- 4 Select **OK**.

### Models with navigation system

The clock is automatically updated through the audio system.

### Models without audio system



- 1 Press the  button to select , then press the **ENTER** button.
- 2 Press the  /  button until **Clock Setup** appears on the display.
- 3 Press the **ENTER** button.
- 4 Press the **ENTER** button to select **Adjust Clock**.
- 5 Press the  /  button to change hour, then press the **ENTER** button.
- 6 Press the  /  button to change minute, then press the **ENTER** button.

## ENGINE START/STOP Button\* P.219

- Press the button to change the vehicle's power mode.

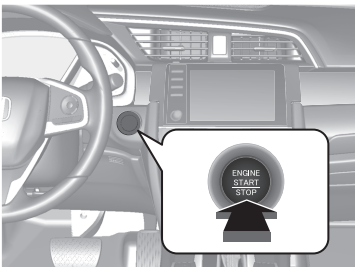

## Turn Signals P.223

Turn Signal Control Lever

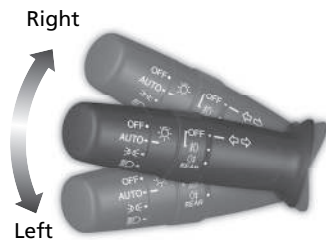

## Lights P.224

Light Control Switches

Models with rear fog light

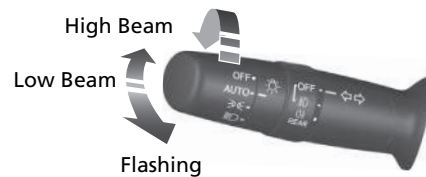

Models without rear fog light

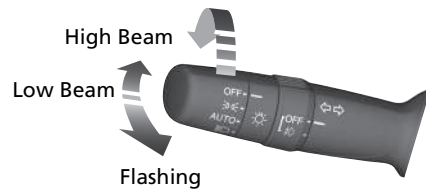

# Wipers and Washers

➔ P. 233

Wiper/Washer Control Lever

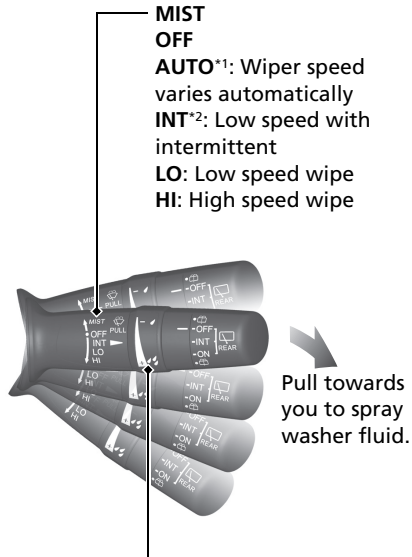

**MIST**  
**OFF**  
**AUTO\*1:** Wiper speed varies automatically  
**INT\*2:** Low speed with intermittent  
**LO:** Low speed wipe  
**HI:** High speed wipe

Pull towards you to spray washer fluid.

Adjustment Ring

- ☐: Low sensitivity\*1
- ☐ 🗲: Lower speed, fewer sweeps\*2
- ⊕: High sensitivity\*1
- ⊕ 🗲: Higher speed, more sweeps\*2

\*1: Models with automatic intermittent wipers  
\*2: Models without automatic intermittent wipers

## Models with automatic intermittent wipers

**AUTO** should always be turned **OFF** before the following situations in order to prevent severe damage to the wiper system:

- Cleaning the windscreen
- Driving through a car wash
- No rain present

## Steering Wheel ➔ P. 239

- To adjust, pull the adjustment lever towards you, adjust to the desired position, then lock the lever back in place.

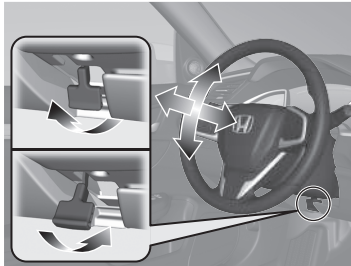

# Unlocking the Front Doors from the Inside

➔ P. 201

- Pull either front door inner handle to unlock and open it at the same time.

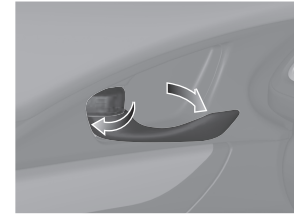

## Hatch ➔ P. 204

Hatch Release Button

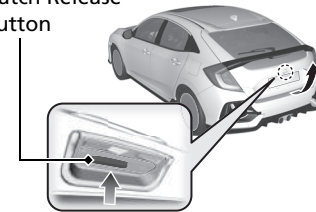

### Models without keyless access system

- With all the doors unlocked, press the hatch release button and lift open the hatch.

### Models with keyless access system

- Press the hatch release button to unlock and open the hatch when you carry the keyless remote.

## Power Door Mirrors

➔ P.241

- With the ignition switch in ON **II**\*1, move the selector switch to **L** or **R**.
- Push the appropriate edge of the adjustment switch to adjust the mirror.
- Press the folding button\* to fold in and out the door mirrors.

Folding Button\*      Selector Switch

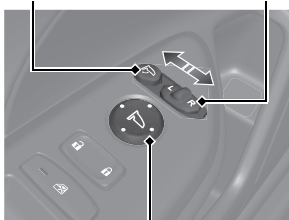

Adjustment Switch

\*1: Models with the keyless access system have an **ENGINE START/STOP** button instead of an ignition switch.

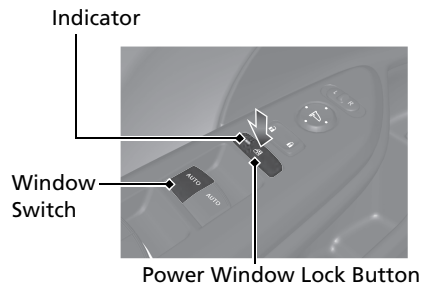

## Power Windows ➔ P.212

- With the ignition switch in ON **II**\*1, open and close the power windows.
- If the power window lock button is in the off position, each passenger's window can be opened and closed with its own switch.
- If the power window lock button is in the on position (indicator on), each passenger's window switch is disabled.





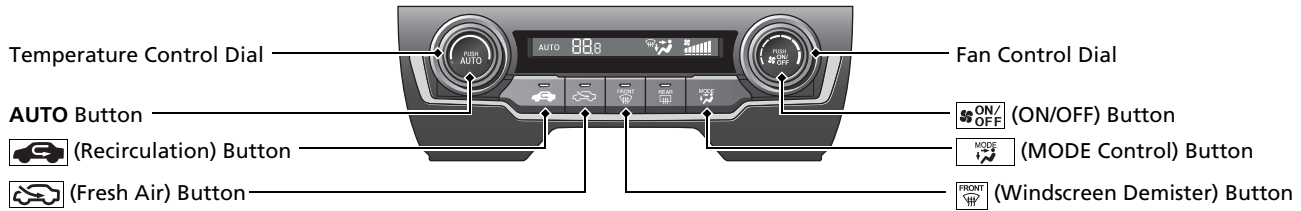

\*1: Models with the keyless access system have an **ENGINE START/STOP** button instead of an ignition switch.

## Heating System\*



- Press the **AUTO** button to activate the heating system.
- Press the  button to turn the system on or off.
- Press the  button to defrost the windscreen.



-  Air flows from floor and windscreen demister vents.
-  Air flows from floor vents.
-  Air flows from floor and dashboard vents.
-  Air flows from dashboard vents.

\* Not available on all models





## Climate Control System\* P.275

- Press the **AUTO** button to activate the climate control system.
- Press the  button to turn the system on or off.
- Press the  button to defrost the windscreen.

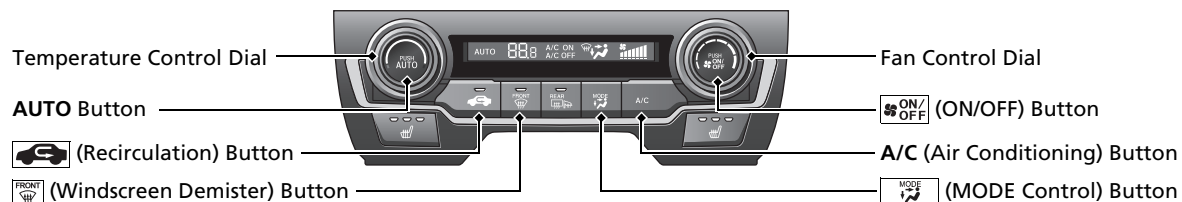
The climate control system is voice operable\*.  P.340

### Models with colour audio system



-  Air flows from floor and windscreen demister vents.
-  Air flows from floor vents.
-  Air flows from floor and dashboard vents.
-  Air flows from dashboard vents.

Models with Display Audio  
 Models without SYNC button

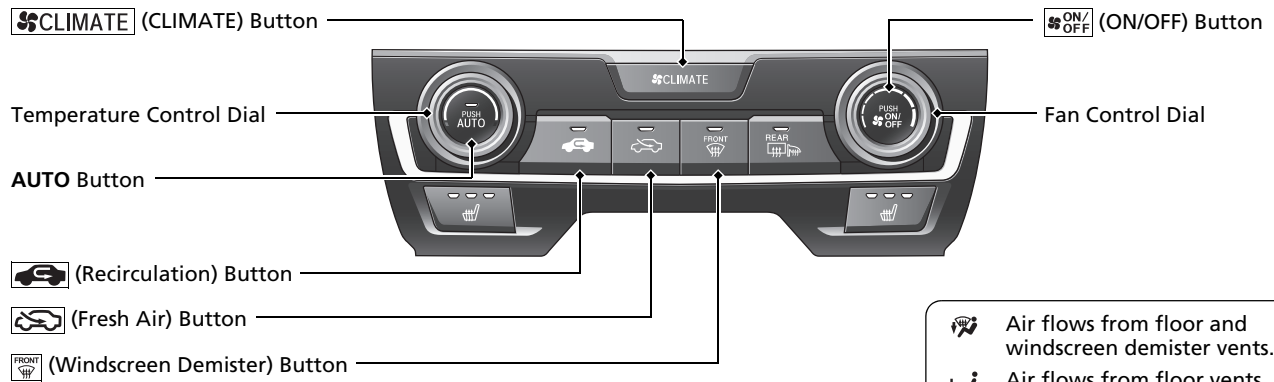
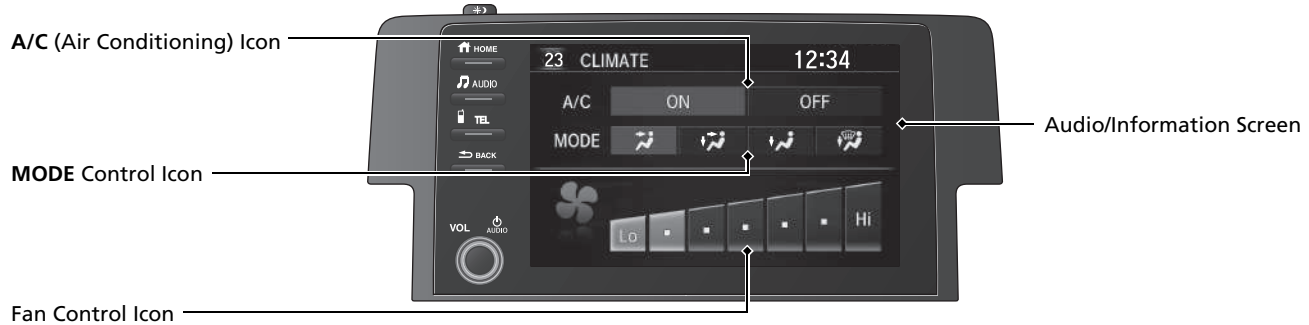

- Air flows from floor and windscreen demister vents.
- Air flows from floor vents.
- Air flows from floor and dashboard vents.
- Air flows from dashboard vents.

\* Not available on all models

Models with Display Audio  
Models with SYNC button

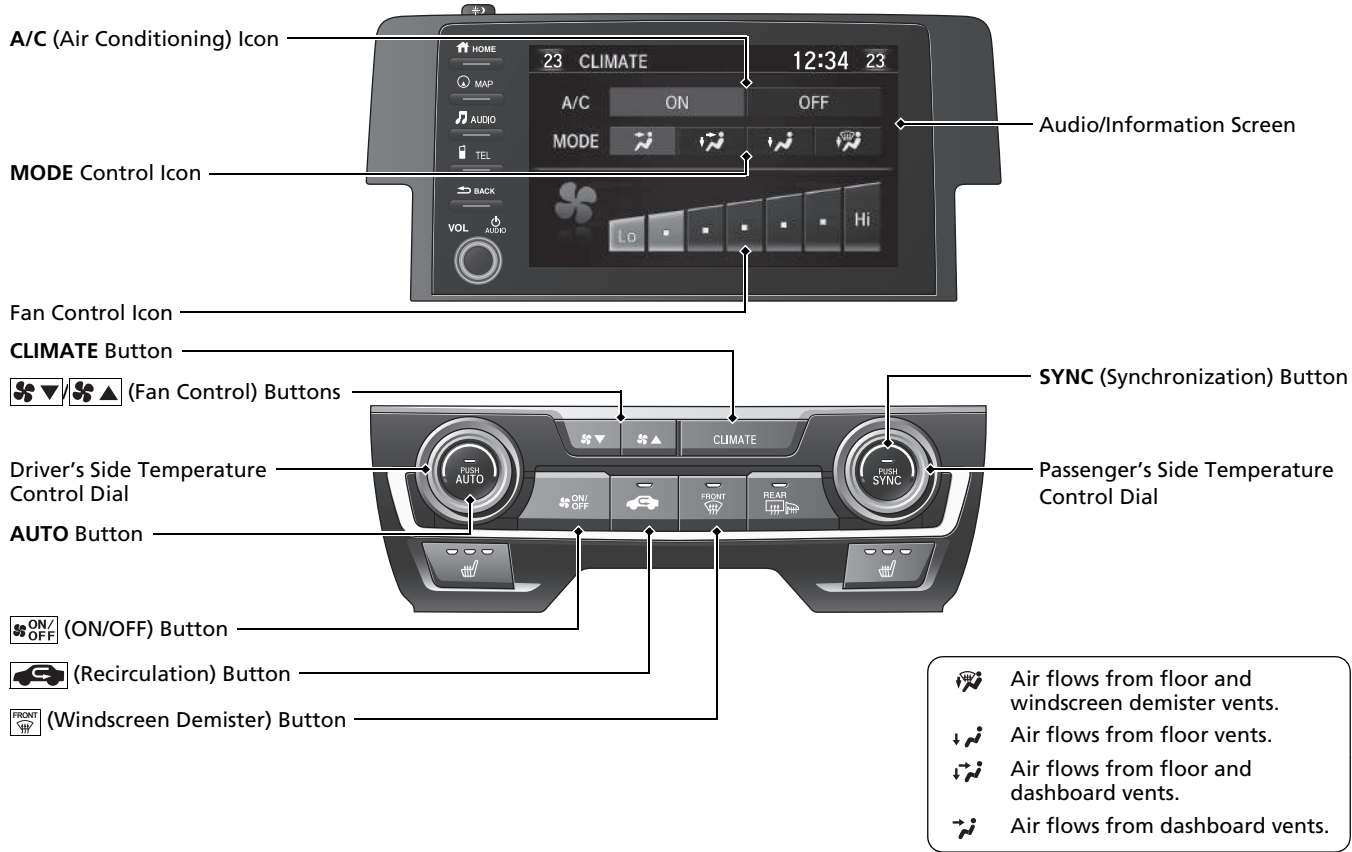



# Features ↔ P.283

## Audio Remote Controls\*

↔ P.288

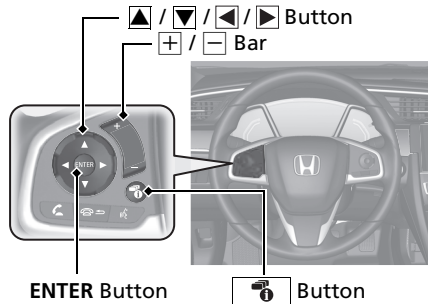

- **+ / - Bar**  
Press to adjust the volume up/down.
- **▲ / ▼ Button**  
Press **▲** or **▼** to cycle through the audio mode as follows:

### Models with Display Audio

FM → DAB\* → LW\* → MW\* → AM\* → USB →  
iPod → Bluetooth® Audio → Apps →  
Audio Apps → AUX-HDMI™

### Models with colour audio system

FM1 → FM2 → DAB1\* → DAB2\* → LW →  
MW → USB → iPod → Bluetooth® Audio

### Models with Display Audio

#### ● ENTER Button

- When listening to the radio

- 1 Press **ENTER** to switch the display to a preset list you stored in the preset buttons.
- 2 Press **▲** or **▼** to select a preset, then press **ENTER**.

- When listening to a USB flash drive

- 1 Press **ENTER** to display the folder list.
- 2 Press **▲** or **▼** to select a folder.
- 3 Press **ENTER** to display a list of files in that folder.
- 4 Press **▲** or **▼** to select a file, then press **ENTER**.





- When listening to an iPod

- 1 Press **ENTER** to display the iPod music list.
- 2 Press **▲** or **▼** to select a category.
- 3 Press **ENTER** to display a list of items in the category.
- 4 Press **▲** or **▼** to select an item, then press **ENTER**.  
▶ Press **ENTER** and press **▲** or **▼** repeatedly until a desired item you want to listen is displayed.

- When listening to Bluetooth® Audio

- 1 Press **ENTER** to display the track list.
- 2 Press **▲** or **▼** to select a track, then press **ENTER**.

\* Not available on all models

-  Button  
Radio: Press to change the preset station.  
Press and hold to select the next or previous strong station.  
Press and hold to select the next or previous ensemble (DAB+).  
USB device:  
Press to skip to the beginning of the next song or return to the beginning of the current song.  
Press and hold to change a folder.
-  Button  
Press to change contents:  
 **Driver Information Interface**  

# Audio System \* P.284

Models with colour audio system  P.290



Driver Information Interface

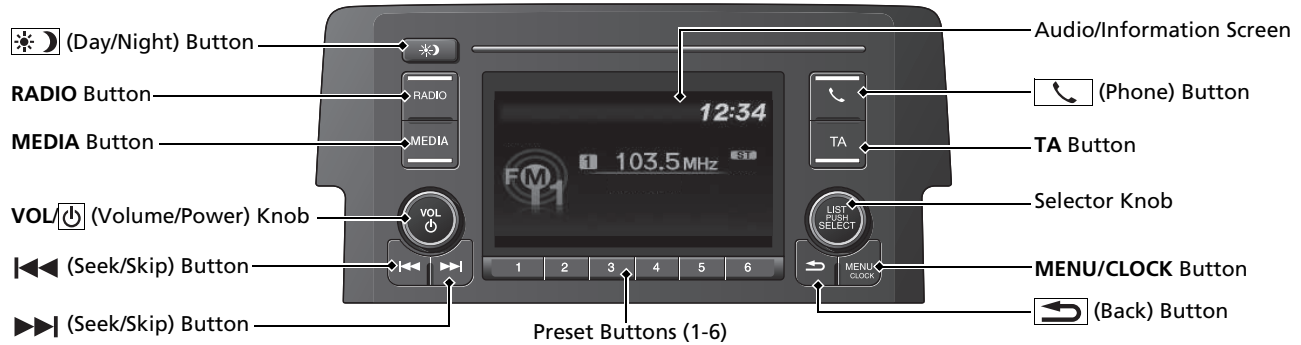

\* Not available on all models

Models with Display Audio P. 315

For navigation system operation See the Navigation System Manual

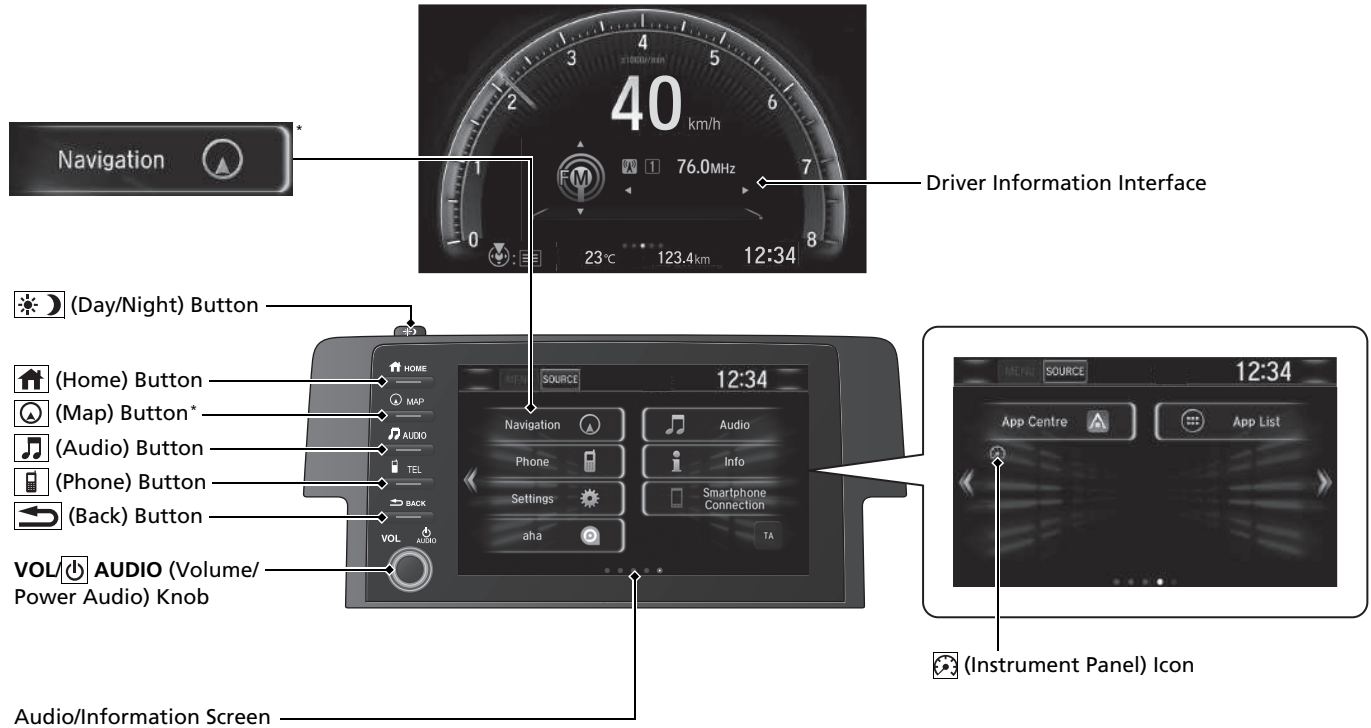

# Driving ↔ P.483

## Manual Transmission\* ↔ P.509

### Continuously Variable Transmission\*

↔ P.502, 504

- Shift to **P** and depress the brake pedal when starting the engine.

#### Shifting

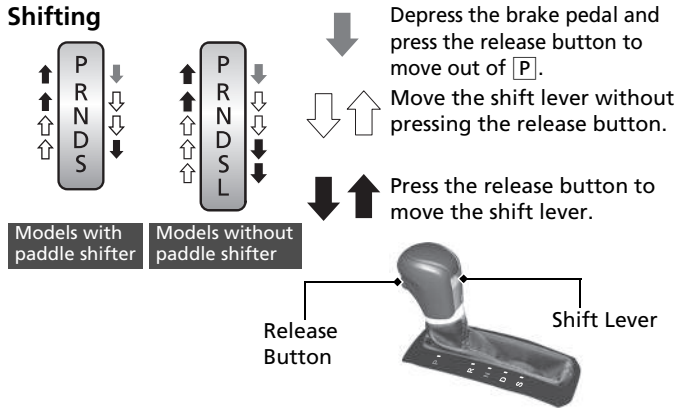

- P** **Park**  
Turn off or start the engine.  
Transmission is locked.
- R** **Reverse**  
Used when reversing.
- N** **Neutral**  
Transmission is not locked.
- D** **Drive**
  - Normal driving.
  - On models with paddle shifter, 7-speed mode can be used temporarily.

- S** **Models with paddle shifters**  
**Drive (S)**  
7-speed manual shift mode can be used.
- S** **Models without paddle shifters**  
**Drive (S)**
  - Better acceleration.
  - Increased engine braking.
  - Going up or down hills.
- L** **Low\***
  - Further increased engine braking.
  - Going up or down hills.

### 7-Speed Manual Shift Mode\* ↔ P.506

- Allows you to manually shift the transmission up or down without releasing your hands from the steering wheel.

#### When the shift lever is in **S**

- Pulling a paddle shifter changes the mode from continuously variable transmission to 7-speed manual shift mode.
- The **M** indicator and the selected speed number are displayed in the shift indicator.

#### When the shift lever is in **D**

- Pulling a paddle shifter temporarily changes the mode from continuously variable transmission to 7-speed manual shift mode. The selected speed number is displayed in the shift indicator.

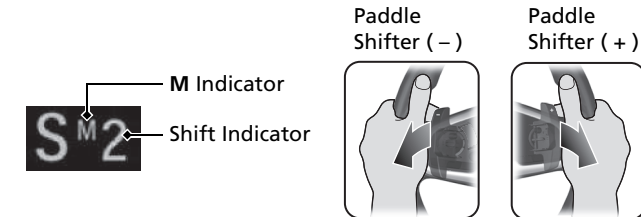

\* Not available on all models

## CMBS\* On and Off ➔ P.569

- When a possible frontal collision is likely unavoidable, the CMBS can help you to reduce the vehicle speed and the severity of the collision.
- The CMBS is turned on every time you start the engine.
- To turn the CMBS on or off, press and hold the button until you hear a beep.

## VSA On and Off ➔ P.545

- The Vehicle Stability Assist (VSA) system helps to stabilise the vehicle during cornering and helps to maintain traction while accelerating on loose or slippery road surfaces.
- VSA comes on automatically every time you start the engine.
- To partially disable or fully restore VSA function, press and hold the button until you hear a beep.

## Cruise Control\* ➔ P.529

- Cruise control allows you to maintain a set speed without keeping your foot on the accelerator pedal.
- To use cruise control, press the **MAIN** button. Select cruise control by pressing the **LIM** button, then press the **–/SET** button once you have achieved the desired speed (above 30 km/h or 18 mph).

## Deflation Warning System ➔ P.549, 553

### Models with rear fog light

- Detects a change in tyre conditions and overall dimensions due to decrease in tyre pressures.
- Deflation warning system is turned on automatically every time you start the engine.
- The initialisation procedure must be performed when certain conditions arise.

### Models without rear fog light

The deflation warning system detects a change in tyre revolutions as a decrease in tyre pressure.

## Adjustable Speed Limiter

### ➔ P.533

- This system enables you to set a maximum speed that cannot be exceeded even if you are depressing the accelerator pedal.
- To use the adjustable speed limiter, press the **MAIN** button. Select the adjustable speed limiter by pressing the **LIM** button, then press the **–/SET** button when your vehicle reaches the desired speed.

### 1.0 L and 1.5 L engine models

- The vehicle speed limit can be set from about 30 km/h (18 mph) to about 250 km/h (156 mph).

### 2.0 L engine models

- The vehicle speed limit can be set from about 30 km/h (18 mph) to about 320 km/h (199 mph).

## Refueling P. 655

### Fuel recommendation:

**1.0 L and 1.5 L engine models**

**EN 228 standards petrol/gasohol fuel**

**Unleaded premium petrol/gasohol up to E10 (90% petrol and 10% ethanol), research octane number 95 or higher**

**2.0 L engine models without rear fog light**



**Unleaded premium petrol, research octane number 95 or higher**

**2.0 L engine models with rear fog light**

**EN 228 standards petrol/gasohol fuel**

**Unleaded premium petrol/gasohol up to E10 (90% petrol and 10% ethanol), research octane number 95 or higher recommended**

**Fuel tank capacity: 46.9 L (10.3 Imp gal)**

- 1 Unlock the driver's door.  
 **Locking/Unlocking the Doors from the Inside**  **P. 201**

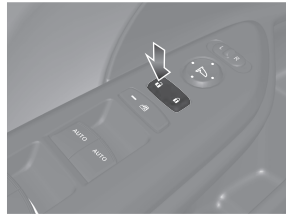

- 2 Press on the edge of the fuel fill door to make it pop up slightly.



- 3 After refueling, wait for about five seconds before removing the filler nozzle.

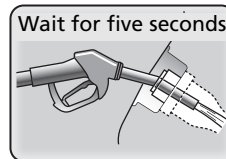

\* Not available on all models

# Honda Sensing\*

➔P.562

Honda Sensing is a driver support system which employs the use of two distinctly different kinds of sensors, a radar sensor located in the lower bumper and a front sensor camera mounted to the interior side of the windscreen, behind the rearview mirror.

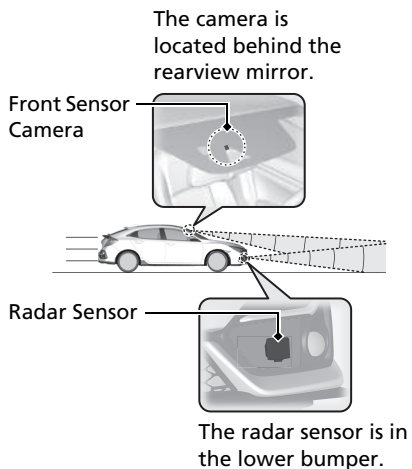

## Collision Mitigation Braking System (CMBS)

➔P.565

Can assist you when there is a possibility of your vehicle colliding with a vehicle or a pedestrian detected in front of yours. The CMBS is designed to alert you when the potential for a collision is determined, as well as to reduce your vehicle speed to help minimise collision severity when a collision is deemed unavoidable.

## Adaptive Cruise Control (ACC) with Low Speed Follow\*

➔P.576

Helps maintain a constant vehicle speed and a set following-interval behind a vehicle detected ahead of yours and, if the detected vehicle comes to a stop, can decelerate and stop your vehicle, without you having to keep your foot on the brake or the accelerator.

## Adaptive Cruise Control (ACC)\*

➔P.593

Helps maintain a constant vehicle speed and a set following-interval behind a vehicle detected ahead of yours, without you having to keep your foot on the brake or the accelerator.

## Lane Keeping Assist System (LKAS)

➔P.609

Provides steering input to help keep the vehicle in the middle of a detected lane and provides tactile, audible and visual alerts if the vehicle is detected drifting out of its lane.



## Road Departure Mitigation System P.617

Alerts and helps to assist you when the system detects a possibility of your vehicle unintentionally crossing over detected lane markings or the edge of the pavement, or leaving the roadway altogether.

## Traffic Sign Recognition System P.623

Reminds you of road sign information, such as the current speed limit and that overtaking is prohibited, your vehicle has just passed through, showing it on the driver information interface.

# Maintenance P.661

## Under the Bonnet P.682

- Check engine oil, engine coolant, and windscreen washer fluid. Add when necessary.
- Check brake/clutch\* fluid.
- Check the battery condition monthly.

- 1 Pull the bonnet release handle under the corner of the dashboard.

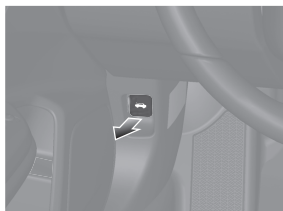

- 2 Locate the bonnet latch lever, pull it up, and then raise the bonnet. Once you have raised the bonnet slightly, you can release the lever.

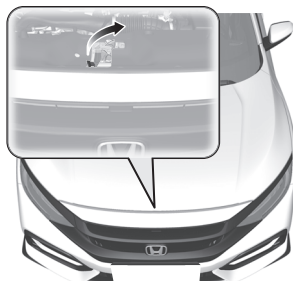

- 3 When finished, close the bonnet and make sure it is firmly locked in place.

## Wiper Blades P.711

- Replace blades if they leave streaks across the windscreen.



## Tyres P.716

- Inspect tyres and wheels regularly.
- Check tyre pressures regularly.
- Install winter tyres for winter driving.

## Lights P.702

- Inspect all lights regularly.

# Handling the Unexpected ➔ P.741

## Flat Tyre ➔ P.744

- Park in a safe location and repair the flat tyre using the tyre repair kit.

Models with a compact spare tyre

- Park in a safe location and replace the flat tyre with the compact spare tyre in the luggage area.



## Engine Won't Start ➔ P.768

- If the battery is dead, jump start using a booster battery.

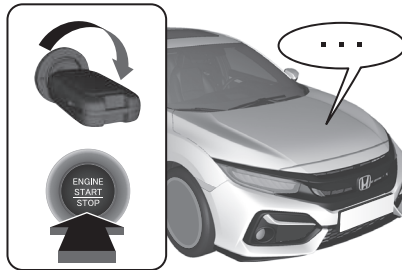

## Overheating ➔ P.779

- Park in a safe location. If you do not see steam under the bonnet, open the bonnet, and let the engine cool down.



## Indicators Come On ➔ P.782

➔ P.782

- Identify the indicator and consult the owner's manual.



## Blown Fuse ➔ P.790

- Check for a blown fuse if an electrical device does not operate.

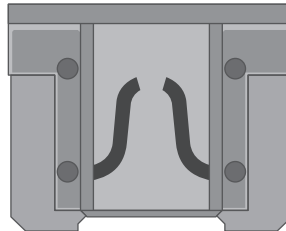

## Emergency Towing ➔ P.797

- Call a professional towing service if you need to tow your vehicle.



\* Not available on all models

# What to Do If

**Q** **Models without keyless access system**  
**The ignition switch does not turn from 0 to I. Why?**

**Models with keyless access system**  
**The power mode does not change from VEHICLE OFF (LOCK) to ACCESSORY. Why?**

**A** The steering wheel may be locked.

**Models without keyless access system**

- Try to turn the steering wheel left and right while turning the ignition key.

**Models with keyless access system**

- Move the steering wheel left and right after pressing the **ENGINE START/STOP** button.



**Q** **Models without keyless access system**  
**The ignition switch does not turn from I to 0 and I cannot remove the key. Why?**

**Models with keyless access system**  
**The power mode does not change from ACCESSORY to VEHICLE OFF (LOCK). Why?**

**A** The shift lever should be moved to P.



**Q** **Why does the brake pedal pulsate slightly when applying the brakes?**

**A** This can occur when the ABS activates and does not indicate a problem. Apply firm, steady pressure on the brake pedal. Never pump the brake pedal.

➔ Anti-lock Brake System (ABS) ➔ P. 639

---

**Q** The rear door cannot be opened from inside the vehicle. Why?

**A** Check if the childproof lock is in the lock position. If so, open the rear door with the outside door handle.

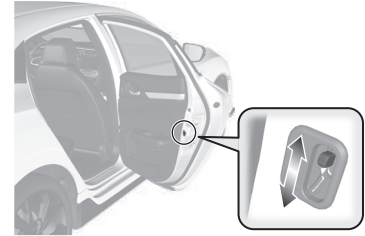

To cancel this function, slide the lever up to the unlock position.

---

**Q** Why do the doors lock after I unlocked the doors?

**A** If you do not open the doors within 30 seconds, the doors are relocked automatically for security.

---

**Q** Why does the beeper sound when I open the driver's door?

**A** The beeper sounds when:

- The exterior lights are left on.
- **Models with keyless access system**
- The power mode is in ACCESSORY.
- **Models with Auto Idle Stop**
- The Auto Idle Stop is in operation.

---

---

**Q** **Models without rear fog light**  
Why does a beeper sound when I walk away from the vehicle after I close the door?

**A** The beeper sounds if you move outside the walk away auto lock operating range before the door completely closes.  
➤ Locking the doors and hatch (Walk away auto lock\*)  
➡ P. 195

---

**Q** Why does the beeper sound when I start driving?

**A** The beeper sounds when the driver and/or front passenger are not wearing their seat belts.

---

**Q** Pressing the electric parking brake switch does not release the parking brake. Why?

**A** Press the electric parking brake switch with the brake pedal depressed.

---

**Q** I'm seeing an amber indicator of a tyre with an exclamation point. What is that?

**A** The Deflation Warning System needs attention. If you recently inflated or changed a tyre, you have to recalibrate the system.  
➤ Deflation Warning System ➡ P. 549, 553

---

**Q** Depressing the accelerator pedal does not release the parking brake automatically. Why?

**A**

- Fasten the driver's seat belt.
- Check if the transmission is in **P**\* or **N**. If so, select any other position.

---



**Why do I hear a screeching sound when I apply the brake pedal?**



The brake pads may need to be replaced. Have your vehicle inspected by a dealer.



1.0 L and 1.5 L engine models  
2.0 L engine models without rear fog light

**Is it possible to use unleaded petrol with a Research Octane Number (RON) of 91 or higher on this vehicle?**



Your vehicle is designed to operate on premium unleaded petrol with a research octane of 95 or higher. If this octane grade is unavailable, regular unleaded petrol with a research octane of 91 or higher may be used temporarily.

The use of regular unleaded petrol can cause metallic knocking noises in the engine and will result in decreased engine performance. The long-term use of regular-grade petrol can lead to engine damage.



2.0 L engine models with rear fog light

**Unleaded petrol with a Research Octane Number (RON) of 95 or higher is recommended.**

**Is it possible to use unleaded petrol with a Research Octane Number (RON) of 91 or lower on this vehicle?**



Use of lower octane petrol can cause occasional metallic knocking noise in the engine and will result in decreased engine performance.

We recommend that you use a research octane of 98 or higher to maximize the performance of the engine.

Use of petrol with a research octane less than 91 can lead to engine damage.





# Safe Driving

You can find many safety recommendations throughout this chapter, and throughout this manual.

## **For Safe Driving**

Important Safety Precautions.....	42
Your Vehicle's Safety Features.....	44
Safety Checklist .....	45

## **Seat Belts**

About Your Seat Belts .....	46
Fastening a Seat Belt .....	52
Seat Belt Inspection.....	56
Anchorage Points.....	57

## **Airbags**

Airbag System Components .....	58
Types of Airbags .....	60

Front Airbags (SRS) .....	60
Side Airbags.....	65
Side Curtain Airbags .....	67
Airbag System Indicators.....	69
Airbag Care .....	70

## **Pop-up Hood System\***

About the Pop-up Hood System.....	71
Pop-up Hood System Care .....	73

## **Child Safety**

Protecting Child Passengers .....	74
Safety of Infants and Small Children....	77
Safety of Larger Children .....	101

## **Exhaust Gas Hazard**

Carbon Monoxide Gas.....	104
--------------------------	-----

## **Safety Labels**

Label Locations .....	105
-----------------------	-----

\* Not available on all models

# For Safe Driving

The following pages explain your vehicle's safety features and how to use them properly. The safety precautions below are ones that we consider to be among the most important.

## Important Safety Precautions

### ■ Always wear your seat belt

A seat belt is your best protection in all types of collisions. Airbags are designed to supplement seat belts, not replace them. So even though your vehicle is equipped with airbags, make sure you and your passengers always wear your seat belts, and wear them properly.

### ■ Restrain all children

Children aged 12 and under should ride properly restrained in a back seat, not the front seat. Infants and small children should be restrained in a child restraint system. Larger children should use a booster seat and a lap/shoulder seat belt until they can use the belt properly without a booster seat.

### ■ Be aware of airbag hazards

While airbags can save lives, they can cause serious or fatal injuries to occupants who sit too close to them, or are not properly restrained. Infants, young children, and short adults are at the greatest risk. Be sure to follow all instructions and warnings in this manual.

### ■ Don't drink and drive

Alcohol and driving don't mix. Even one drink can reduce your ability to respond to changing conditions, and your reaction time gets worse with every additional drink. So don't drink and drive, and don't let your friends drink and drive, either.

### ⓘ Important Safety Precautions

Some countries prohibit the use of mobile phones other than hands-free devices by the driver while driving.

■ **Pay appropriate attention to the task of driving safely**

Engaging in mobile phone conversation or other activities that keep you from paying close attention to the road, other vehicles, and pedestrians could lead to a crash. Remember, situations can change quickly, and only you can decide when it is safe to divert some attention away from driving.

■ **Control your speed**

Excessive speed is a major factor in crash injuries and deaths. Generally, the higher the speed, the greater the risk, but serious injuries can also occur at lower speeds. Never drive faster than is safe for current conditions, regardless of the maximum speed posted.

■ **Keep your vehicle in safe condition**

Having a tyre blowout or a mechanical failure can be extremely hazardous. To reduce the possibility of such problems, check your tyre pressures and condition frequently, and perform all regularly scheduled maintenance.

■ **Do not leave children unattended in the vehicle**

Children, pets and people needing assistance left unattended in the vehicle may be injured if they activate one or more of the vehicle controls. They may also cause the vehicle to move, resulting in a crash in which they and/or another person(s) can be injured or killed. Also, depending on the ambient temperature, the temperature of the interior may reach extreme levels, which can result in harm or death. Even if the climate control system is on, never leave them in the vehicle unattended as the climate control system can shut off at any time.

## Your Vehicle's Safety Features

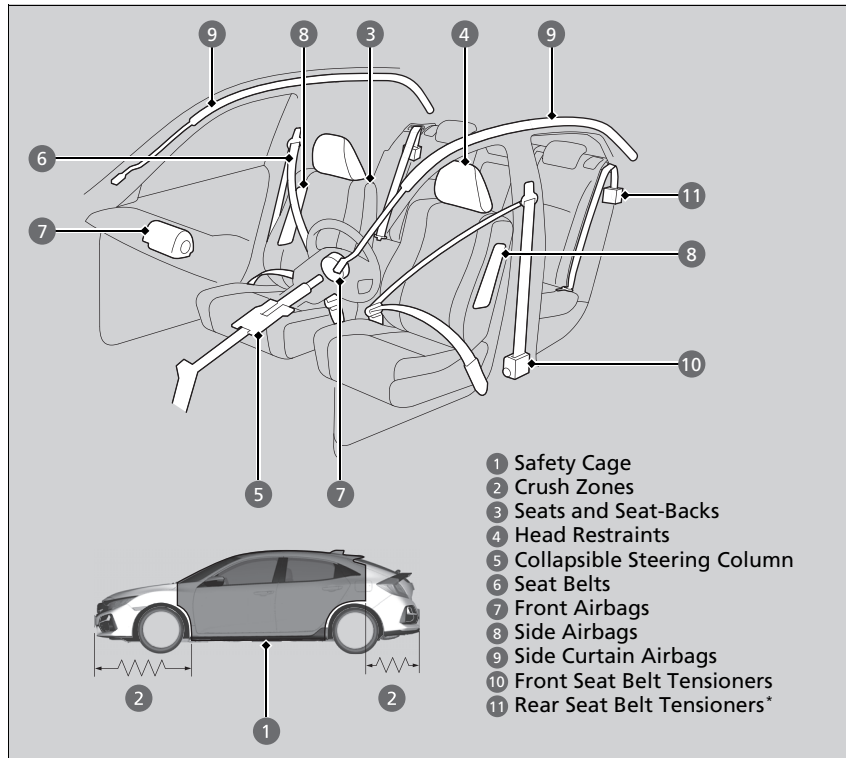

The following checklist will help you take an active role in protecting yourself and your passengers.

### ► Your Vehicle's Safety Features

Your vehicle is equipped with many features that work together to help to protect you and your passengers during a crash.

Some features do not require any action on your part. These include a strong steel framework that forms a safety cage around the passenger compartment, front and rear crush zones, a collapsible steering column, and tensioners that tighten the seat belts in a sufficient crash.

However, you and your passengers cannot take full advantage of these features unless you remain seated in the correct position and always wear your seat belts. In fact, some safety features can contribute to injuries if they are not used properly.

## Safety Checklist

For the safety of you and your passengers, make a habit of checking these items each time before you drive.

- Adjust your seat to a position suitable for driving. Be sure the front seats are adjusted as far to the rear as possible while allowing the driver to control the vehicle. Sitting too close to a front airbag can result in serious or fatal injury in a crash.

➤ **Adjusting the Seats** P. 243

### Except 2.0 L engine models

- Adjust head restraints to the proper position. Head restraints are most effective when the centre of the head restraint aligns with the centre of your head. Taller persons should adjust their head restraint to the highest position.

➤ **Adjusting the Front Head Restraints Positions** P. 243

- Always wear your seat belt, and make sure you wear it properly. Confirm that any passengers are properly belted as well.

➤ **Fastening a Seat Belt** P. 52

- Protect children by using seat belts or child restraint systems according to a child's age, height and weight.

➤ **Child Safety** P. 74

### ➤ Safety Checklist

If the door and/or hatch open message appears on the driver information interface, a door and/or the hatch is not completely closed. Close all doors and the hatch tightly until the message disappears.

➤ **Driver Information Interface Warning and Information Messages** P. 135

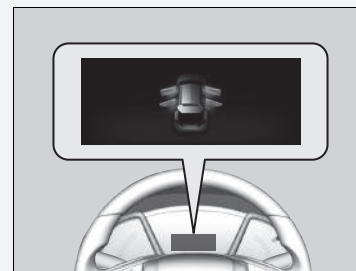

# Seat Belts

## About Your Seat Belts

Seat belts are the single most effective safety device because they keep you connected to the vehicle so that you can take advantage of many built-in safety features. They also help to keep you from being thrown against the inside of the vehicle, against any passengers, or out of the vehicle. When worn properly, seat belts also keep your body properly positioned in a crash so that you can take full advantage of the additional protection provided by the airbags.

In addition, seat belts help to protect you in almost every type of crash, including:

- frontal impacts
- side impacts
- rear impacts
- rollovers

### About Your Seat Belts

#### **WARNING**

**Not wearing a seat belt properly increases the chance of serious injury or death in a crash, even though your vehicle has airbags.**

**Be sure you and your passengers always wear seat belts and wear them properly.**

**WARNING:** Seat belts are designed to bear upon the bony structure of the body, and should be worn low across the front of the pelvis or the pelvis, chest and shoulders, as applicable; wearing the lap section of the belt across the abdominal area must be avoided.

**WARNING:** Seat belts should be adjusted as firmly as possible, consistent with comfort, to provide the protection for which they have been designed. A slack belt will greatly reduce the protection afforded to the wearer.

**WARNING:** Belts should not be worn with straps twisted.

**WARNING:** Each belt assembly must only be used by one occupant; it is dangerous to put a belt around a child being carried on the occupant's lap.

### ■ Lap/shoulder seat belts

All four or five seating positions are equipped with lap/shoulder seat belts with emergency locking retractors. In normal driving the retractor lets you move freely while keeping some tension on the belt. During a collision or sudden stop the retractor locks to restrain your body.

The seat belt must be properly secured when using a front-facing child restraint system.

➤ **Installing a Child Restraint System with a Lap/Shoulder Seat Belt** P. 96

### ▣ About Your Seat Belts

If you extend the seat belt too quickly, it will lock in place. If this happens, slightly retract the seat belt, then extend it slowly.

Seat belts cannot completely protect you in every crash. But in most cases, seat belts can reduce your risk of serious injury.

Most countries require you to wear seat belts. Take time to familiarise with the legal requirements of the countries in which you will drive.

*Continued*

■ **Proper use of seat belts**

Follow these guidelines for proper use:

- All occupants should sit upright, well back in the seat, and remain in that position for the duration of the trip. Slouching and leaning reduce the effectiveness of the belt and can increase the chance of serious injury in a crash.
- Never place the shoulder part of a lap/shoulder seat belt under your arm or behind your back. This could cause very serious injuries in a crash.
- Two people should never use the same seat belt. If they do, they could be very seriously injured in a crash.
- Do not put any accessories on the seat belts. Devices intended to improve comfort or reposition the shoulder part of a seat belt can reduce the protective capability and increase the chance of serious injury in a crash.



## ■ Seat Belt Reminder

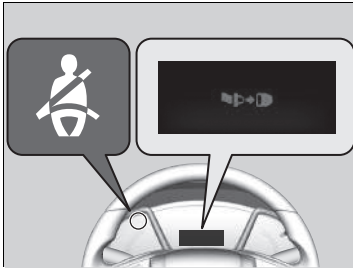

### ■ Front seats

#### Models with rear fog light

The seat belt system includes an indicator on the instrument panel to remind the driver or a front passenger or both to fasten their seat belts. If the ignition switch is turned to ON **II**\*1 and a seat belt is not fastened, the indicator will come on and remain illuminated until the seat belt is fastened.

#### Models without rear fog light

The seat belt system includes an indicator on the instrument panel to remind the driver to fasten a seat belt. If you set the power mode to ON and a seat belt is not fastened, the indicator will come on and remain illuminated until a seat belt is fastened.

The beeper will periodically sound and the indicator will blink while the vehicle is moving until the seat belt is fastened.

### » Seat Belt Reminder

#### Models with rear fog light

The indicator will also come on if a front passenger does not fasten their seat belt within six seconds after the ignition switch is turned to ON **II**\*1.

When no one is sitting in the front passenger's seat, the indicator will not come on and the beeper will not sound.

If the indicator comes on or the beeper sounds with no one sitting in the front passenger's seat.

Check if:

- There is nothing heavy placed on the front passenger seat.
- The driver's seat belt is fastened.

If the indicator does not light when the passenger is seated and is not fastened, something may be interfering with the occupant detection sensor.

Check if:

- A cushion is placed on the seat.
- The front passenger is not sitting properly.

If none of these conditions exist, have your vehicle checked by a dealer.

\*1: Models with the keyless access system have an **ENGINE START/STOP** button instead of an ignition switch.

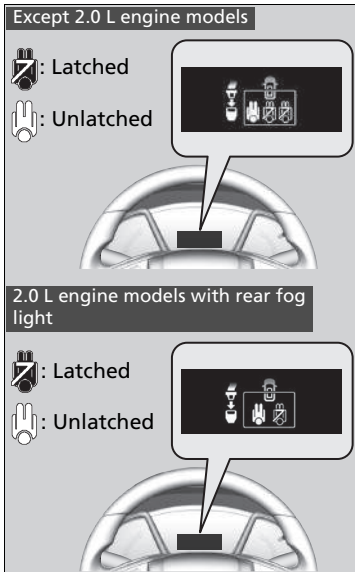

■ **Rear seats\***

Your vehicle monitors rear seat belt use. A driver information interface notifies you if any of the rear seat belts are used.

The display appears when:

- A rear door is opened and closed.
- Any of the rear passengers fastened or unfastened their seat belt.

The beeper sounds if any rear passenger's seat belt is unlatched while driving.

## Automatic Seat Belt Tensioners

### Models without rear fog light

The front seats are equipped with automatic seat belt tensioners to enhance safety.

The tensioners automatically tighten the front seat belts during a moderate-to-severe frontal collision, sometimes even if the collision is not severe enough to inflate the front airbags.

### Models with rear fog light

The front seats and the outer rear seats are equipped with automatic seat belt tensioners to enhance safety.

The tensioners automatically tighten the front seat belts and the outer rear seat belts during a moderate-to-severe frontal collision, sometimes even if the collision is not severe enough to inflate the front airbags.

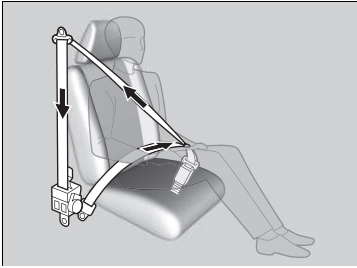

### Automatic Seat Belt Tensioners

The seat belt tensioners can only operate once. If a tensioner is activated, the SRS indicator will come on. Have a dealer replace the tensioner and thoroughly inspect the seat belt system as it may not offer protection in a subsequent crash.

During a moderate-to-severe side impact, the tensioner on that side of the vehicle also activates.

## Fastening a Seat Belt

After adjusting a front seat to the proper position, and while sitting upright and well back in the seat:

✦ **Adjusting the Seats** P. 243

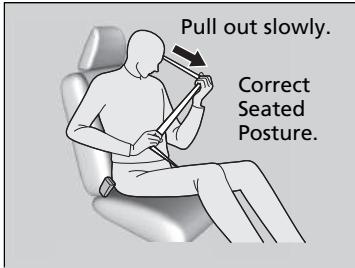

1. Pull the seat belt out slowly.

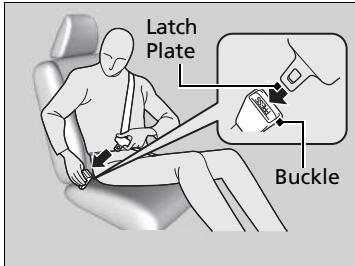

2. Insert the latch plate into the buckle, then tug on the belt to make sure the buckle is secure.

▶ Make sure that the belt is not twisted or caught on anything.

### ✦ Fastening a Seat Belt

No one should sit in a seat with an inoperative seat belt or one that does not appear to be working correctly. Using a seat belt that is not working properly may not protect the occupant in a crash. Have a dealer check the belt as soon as possible.

If the seat belt appears to be locked in a fully retracted position, firmly pull out on the shoulder belt once, then push it back in. Then smoothly pull it out of the retractor and fasten. If you are unable to release the seat belt from a fully retracted position, do not allow anyone to sit in the seat, and take your vehicle to a dealer for repair.

✦ **About Your Seat Belts** P. 46

✦ **Seat Belt Inspection** P. 56



3. Position the lap part of the belt as low as possible across your hips, then pull up on the shoulder part of the belt so the lap part fits snugly. This lets your strong pelvic bones take the force of a crash and reduces the chance of internal injuries.
4. If necessary, pull up on the belt again to remove any slack, then check that the belt rests across the centre of your chest and over your shoulder. This spreads the forces of a crash over the strongest bones in your upper body.

#### Fastening a Seat Belt

### **⚠ WARNING**

Improperly positioning the seat belts can cause serious injury or death in a crash.

**Make sure all seat belts are properly positioned before driving.**

To release the belt, push the red **PRESS** button and then guide the belt by hand until it has retracted completely.

When exiting the vehicle, be sure the belt is properly stowed so that it will not get caught in the closing door.

Never insert any foreign objects into the buckle or retractor mechanism.

*Continued*

## ■ Adjusting the Shoulder Anchor

The front seats have adjustable shoulder anchors to accommodate taller and shorter occupants.

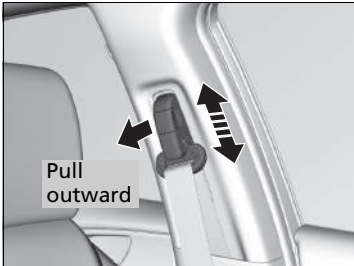

1. Move the anchor up and down while pulling the shoulder anchor outward.
2. Position the anchor so that the belt rests across the centre of your chest and over your shoulder.

## ▣ Adjusting the Shoulder Anchor

The shoulder anchor height can be adjusted to four levels. If the belt contacts your neck, lower the height one level at a time.

After an adjustment, make sure that the shoulder anchor position is secure.

## ■ Advice for Pregnant Women

If you are pregnant, the best way to protect yourself and your unborn child when driving or riding in a vehicle is to always wear a seat belt. When positioning the seat belt, wear the shoulder belt section across the chest, avoiding the abdomen, and keep the lap belt portion as low as possible across the hips. (See illustration.)

Wear the shoulder belt across the chest avoiding the abdomen.



Wear the lap part of the belt as low as possible across the hips.

## ▣ Advice for Pregnant Women

Each time you have a checkup, ask your doctor if it is okay for you to drive.

To reduce the risk of injuries to both you and your unborn child that can be caused by an inflating front airbag:

- When driving, sit upright and adjust the seat as far back as possible while allowing full control of the vehicle.
- When sitting in the front passenger's seat, adjust the seat as far back as possible.

## Seat Belt Inspection

Regularly check the condition of your seat belts as follows:

- Pull each belt out fully, and look for frays, cuts, burns, and wear.
- Check that the latch plates and buckles work smoothly and the belts retract easily.
  - If a belt does not retract easily, cleaning the belt may correct the problem. Only use a mild soap and warm water. Do not use bleach or cleaning solvents. Make sure the belt is completely dry before allowing it to retract.

Any belt that is not in good condition or working properly will not provide proper protection and should be replaced as soon as possible.

A belt that has been worn during a crash may not provide the same level of protection in a subsequent crash. Have your seat belts inspected by a dealer after any collision.

### Seat Belt Inspection

#### **WARNING**

**Not checking or maintaining seat belts can result in serious injury or death if the seat belts do not work properly when needed.**

**Check your seat belts regularly and have any problem corrected as soon as possible.**

**WARNING:** No modifications or additions should be made by the user which will either prevent the seat belt adjusting devices from operating to remove slack, or prevent the seat belt assembly from being adjusted to remove slack.

**WARNING:** It is essential to replace the entire assembly after it has been worn in a severe impact even if damage to the assembly is not obvious.

**WARNING:** Care should be taken to avoid contamination of the webbing with polishes, oils and chemicals, and particularly battery acid. Cleaning may safely be carried out using mild soap and water. The belt should be replaced if webbing becomes frayed, contaminated or damaged.



## Anchorage Points

Front Seat

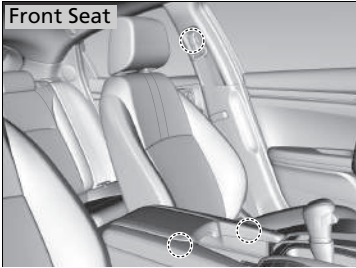

When replacing the seat belts, use the anchorage points shown in the images. The front seat has a lap/shoulder belt.

Except 2.0 L engine models

Rear Seat

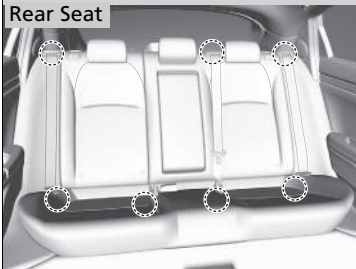

Except 2.0 L engine models

The rear seat has three lap/shoulder belts.

2.0 L engine models

Rear Seat

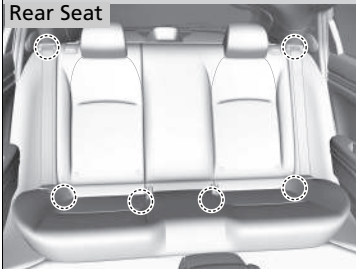

2.0 L engine models

The rear seat has two lap/shoulder belts.

## Airbag System Components

The front, front side, and side curtain airbags are deployed according to the direction and severity of impact. The airbag system includes:

- Two SRS (Supplemental Restraint System) front airbags. The driver's airbag is stored in the centre of the steering wheel; the front passenger's airbag is stored in the dashboard. Both are marked **SRS AIRBAG**.
- Two side airbags, one for the driver and one for a front passenger. The airbags are stored in the outer edges of the seat-backs. Both are marked **SIDE AIRBAG**.
- Two side curtain airbags, one for each side of the vehicle. The airbags are stored in the ceiling, above the side windows. The front and rear pillars are marked **SIDE CURTAIN AIRBAG**.
- An electronic control unit that, when the ignition switch is in ON **II**\*1, continually monitors information about the various impact sensors, seat and buckle sensors, airbag activators, seat belt tensioners, and other vehicle information. During a crash event the unit can record such information.
- Automatic seat belt tensioners for the front seats and outer rear seats\*.
- Impact sensors that can detect a moderate-to-severe front or side impact.
- An indicator on the instrument panel that alerts you to a possible problem with your airbag system or seat belt tensioners.

### Models with rear fog light

- An indicator on the dashboard that alerts you that the front passenger's front airbag has been turned off.

\*1: Models with the keyless access system have an **ENGINE START/STOP** button instead of an ignition switch.

## ■ Important Facts About Your Airbags

Airbags can pose serious hazards. To do their job, airbags must inflate with tremendous force. So, while airbags help to save lives, they can cause burns, bruises, and other minor injuries, sometimes even fatal ones if occupants are not wearing their seat belts properly and sitting correctly.

**What you should do:** Always wear your seat belt properly, and sit upright and as far back from the steering wheel as possible while allowing full control of the vehicle. A front passenger should move their seat as far back from the dashboard as possible.

Remember, however, that no safety system can prevent all injuries or deaths that can occur in a severe crash, even when seat belts are properly worn and the airbags deploy.

**Do not place hard or sharp objects between yourself and a front airbag.**

Carrying hard or sharp objects on your lap, or driving with a pipe or other sharp object in your mouth, can result in injuries if your front airbag inflates.

**Do not attach or place objects on the front airbag covers.** Objects on the covers marked **SRS AIRBAG** could interfere with the proper operation of the airbags or be propelled inside the vehicle and hurt someone if the airbags inflate.

## ▣ Important Facts About Your Airbags

Do not attempt to deactivate your airbags. Together, airbags and seat belts provide the best protection.

When driving, keep hands and arms out of the deployment path of the front airbag by holding each side of the steering wheel. Do not cross an arm over the airbag cover.

## Types of Airbags

Your vehicle is equipped with three types of airbags:

- **Front airbags:** Airbags in front of the driver's and front passenger's seats.
- **Side airbags:** Airbags in the driver's and front passenger's seat-backs.
- **Side curtain airbags:** Airbags above the side windows.

Each is discussed in the following pages.

### Front Airbags (SRS)

The front SRS airbags inflate in a moderate-to-severe frontal collision to help to protect the head and chest of the driver and/or front passenger.

**SRS** (Supplemental Restraint System) indicates that the airbags are designed to supplement seat belts, not replace them. Seat belts are the occupant's primary restraint system.

#### Housing Locations

The front airbags are housed in the centre of the steering wheel for the driver, and in the dashboard for the front passenger. Both airbags are marked **SRS AIRBAG**.

#### Types of Airbags

The airbags can inflate whenever the ignition switch is in ON **II**\*1.

After an airbag inflates in a crash, you may see a small amount of smoke. This is from the combustion process of the inflator material and is not harmful. People with respiratory problems may experience some temporary discomfort. If this occurs, get out of the vehicle as soon as it is safe to do so.

\*1: Models with the keyless access system have an **ENGINE START/STOP** button instead of an ignition switch.

## ■ Operation

Front airbags are designed to inflate during moderate-to-severe frontal collisions. When the vehicle decelerates suddenly, the sensors send information to the control unit which signals one or both front airbags to inflate.

A frontal collision can be either head-on or angled between two vehicles, or when a vehicle crashes into a stationary object, such as a concrete wall.

## ■ How the Front Airbags Work

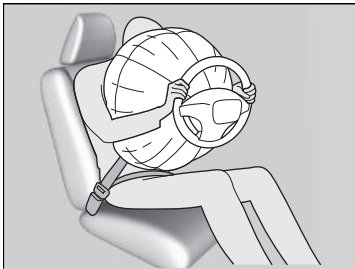

While your seat belt restrains your torso, the front airbag provides supplemental protection for your head and chest.

The front airbags deflate immediately so that they won't interfere with the driver's visibility or the ability to steer or operate other controls.

The total time for inflation and deflation is so fast that most occupants are not aware that the airbags deployed until they see them lying in front of them.

### ■ When front airbags should not deploy

**Minor frontal crashes:** Front airbags were designed to supplement seat belts and help to save lives, not to prevent minor scrapes, or even broken bones that might occur during a less than moderate-to-severe frontal crash.

**Side impacts:** Front airbags can provide protection when a sudden deceleration causes a driver or front passenger to move towards the front of the vehicle. Side airbags and side curtain airbags have been specifically designed to help to reduce the severity of injuries that can occur during a moderate-to-severe side impact which can cause the driver or passenger to move towards the side of the vehicle.

**Rear impacts:** Head restraints and seat belts are your best protection during a rear impact. Front airbags cannot provide any significant protection and are not designed to deploy in such collisions.

**Rollovers:** Seat belts and side curtain airbags offer the best protection in a rollover. Because front airbags could provide little if any protection, they are not designed to deploy during a rollover.

### ■ When front airbags deploy with little or no visible damage

Because the airbag system senses sudden deceleration, a strong impact to the vehicle framework or suspension might cause one or more of the airbags to deploy. Examples include running into a curb, the edge of a hole, or other low fixed object that causes a sudden deceleration in the vehicle chassis. Since the impact is underneath the vehicle, damage may not be readily apparent.

### ■ When front airbags may not deploy, even though exterior damage appears severe

Since crushable body parts absorb crash energy during an impact, the amount of visible damage does not always indicate proper airbag operation. In fact, some collisions can result in severe damage but no airbag deployment because the airbags would not have been needed or would not have provided protection even if they had deployed.

## ■ Passenger Front Airbag Off System \*

If it is unavoidable to install a rear-facing child restraint system in the front passenger seat, you must manually deactivate the passenger front airbag system, using the ignition key or built in key.

### ■ Passenger front airbag ON/OFF switch

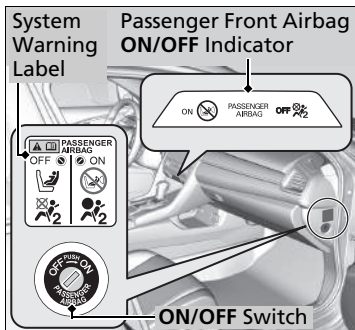

When the passenger front airbag **ON/OFF** switch is in:

**OFF:** The passenger front airbag is deactivated. The passenger front airbag does not inflate during a frontal crash that inflates driver's front airbag.

The passenger front airbag off indicator stays on as a reminder.

**ON:** The passenger front airbag is activated. The passenger front airbag on indicator comes on and remains on for about 60 seconds.

### ■ To deactivate the passenger front airbag system

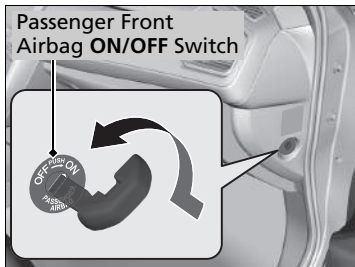

1. Set the parking brake, and turn the ignition switch to LOCK [0]\*1. Remove the key.
2. Open the front passenger's door.
3. Insert the key to the passenger front airbag **ON/OFF** switch.
  - ▶ The switch is located at the side panel of the front passenger side instrument panel.
4. Turn the key to **OFF**, and remove it from the switch.

\*1: Models with the keyless access system have an **ENGINE START/STOP** button instead of an ignition switch.

\* Not available on all models

### ▶▶ Passenger Front Airbag Off System \*

## ⚠ WARNING

The passenger front airbag system must be turned off, if it is not avoidable to put a rear-facing child restraint system in the front passenger seat.

If the front passenger airbag inflates, it can hit the rear-facing child restraint system with enough force to kill or cause a very serious injury to the infant.

## ⚠ WARNING

Make sure to turn on the passenger front airbag system when a rear-facing child restraint system is not used on the front passenger seat.

Leaving the passenger front airbag system deactivated can result in serious injury or death in a crash.

Continued

### ■ Passenger front airbag off indicator

When the passenger front airbag system is activated, the indicator goes off after a few seconds when you turn the ignition switch to ON \*1.

When the passenger front airbag system is deactivated, the indicator stays on, or goes off momentarily and comes back on.

### ■ Passenger front airbag off system label

The label is located at the side panel of the front passenger side instrument panel.

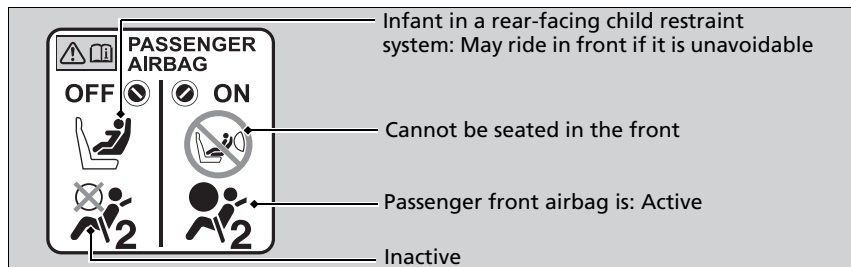

\*1: Models with the keyless access system have an **ENGINE START/STOP** button instead of an ignition switch.

\* Not available on all models

### ⊗ Passenger Front Airbag Off System \*

#### NOTICE

- Use your vehicle's ignition key or built in key to turn the passenger front airbag **ON/OFF** switch. If you use a different key, the switch can be damaged, or the passenger front airbag system may not work properly.
- Do not close the door or apply an excessive load on the ignition key or built in key while the key is in the passenger front airbag **ON/OFF** switch. The switch or the key can be damaged.

We strongly recommend that you do not install a rear-facing child restraint system in the front passenger seat.

#### 📄 Protecting Infants P. 77

It is your responsibility to change the setting of the passenger front airbag system to **OFF** when you put a rear-facing child restraint system on the front passenger seat.

When a rear-facing child restraint system is not in use in the front passenger seat, turn the system back on.



## Side Airbags

The side airbags help to protect the torso and pelvis of the driver or a front passenger during a moderate-to-severe side impact.

### ■ Housing Locations

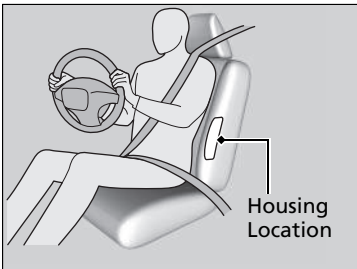

The side airbags are housed in the outside edge of the driver's and passenger's seat-backs.

Both are marked **SIDE AIRBAG**.

### ▣ Side Airbags

Do not let the front passenger lean sideways with their head in the deployment path of the side airbag. An inflating side airbag can strike with strong force and seriously injure the passenger.

Do not attach accessories on or near the side airbags. They can interfere with the proper operation of the airbags, or hurt someone if an airbag inflates.

## ■ Operation

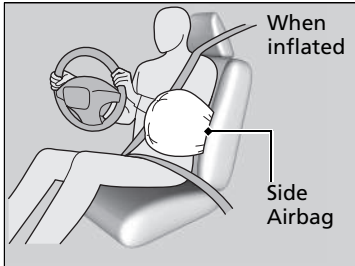

When the sensors detect a moderate-to-severe side impact, the control unit signals the side airbag on the impact side to immediately inflate.

### ■ When a side airbag deploys with little or no visible damage

Because the airbag system senses sudden acceleration, a strong impact to the side of the vehicle's framework can cause a side airbag to deploy. In such cases, there may be little or no damage, but the side impact sensors detected a severe enough impact to deploy the airbag.

### ■ When a side airbag may not deploy, even though visible damage appears severe

It is possible for a side airbag not to deploy during an impact that results in apparently severe damage. This can occur when the point of impact was towards the far front or rear of the vehicle, or when the vehicle's crushable body parts absorbed most of the crash energy. In either case, the side airbag would not have been needed nor provided protection even if it had deployed.

## ⊗ Side Airbags

Do not cover or replace the front seat-back covers without consulting a dealer. Improperly replacing or covering front seat-back covers can prevent your side airbags from properly deploying during a side impact.

## Side Curtain Airbags

### 2.0 L engine models

The side curtain airbags help to protect the heads of the driver and any passengers during a moderate-to-severe side impact.

### Except 2.0 L engine models

The side curtain airbags help to protect the heads of the driver and passengers in outer seating positions during a moderate-to-severe side impact.

### ■ Housing Locations

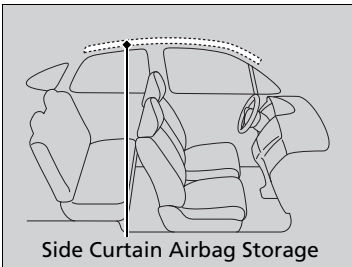

The side curtain airbags are located in the ceiling above the side windows on both sides of the vehicle.

### ▣ Side Curtain Airbags

The side curtain airbags are most effective when an occupant is wearing their seat belt properly and sitting upright, well back in their seat.

Do not attach any objects to the side windows or roof pillars as they can interfere with the proper operation of the side curtain airbags.

Do not put a coat hanger or hard objects on a coat hook. This could result in injuries if your side curtain airbag inflates.

*Continued*

## ■ Operation

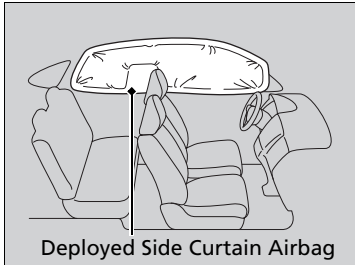

The side curtain airbag is designed to deploy in a moderate-to-severe side impact.

### ■ When side curtain airbags deploy in a frontal collision

One or both side curtain airbags may also inflate in a moderate-to-severe angled frontal collision.

## Airbag System Indicators

If a problem occurs in the airbag system, the SRS indicator will come on and a message appears on the driver information interface.

### ■ Supplemental Restraint System (SRS) Indicator

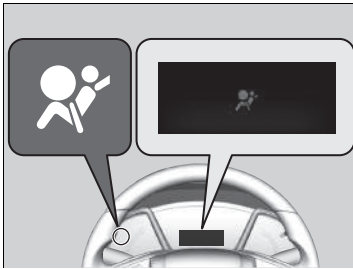

#### ■ When the ignition switch is turned to ON \*1

The indicator comes on for a few seconds, then goes off. This tells you the system is working properly.

If the indicator comes on at any other time, or does not come on at all, have the system checked by a dealer as soon as possible. If you don't, your airbags and seat belt tensioners may not work properly when they are needed.

\*1: Models with the keyless access system have an **ENGINE START/STOP** button instead of an ignition switch.

### ▣ Supplemental Restraint System (SRS) Indicator

#### ⚠ WARNING

Ignoring the SRS indicator can result in serious injury or death if the airbag systems or tensioners do not work properly.

Have your vehicle checked by a dealer as soon as possible if the SRS indicator alerts you to a possible problem.

#### ▣ Models with rear fog light

#### ⚠ WARNING

Remove the rear-facing child restraint system immediately from the front passenger seat if the SRS indicator comes on. Even if the passenger front airbag has been deactivated, do not ignore the SRS indicator.

The SRS system may have a fault which could cause the passenger front airbag to be activated, causing serious injury or death.

Continued

## ■ Passenger Front Airbag Off Indicator \*

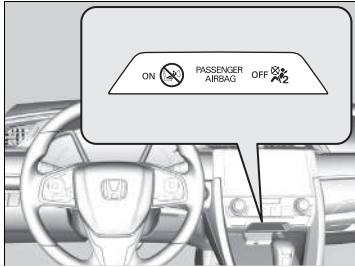

### ■ When the passenger airbag off indicator comes on

The indicator stays on while the passenger's front airbag system is deactivated.

When a rear-facing child restraint system is not in use in the front passenger seat, manually turn the system back on. The indicator should go off.

## Airbag Care

You do not need to, and should not, perform any maintenance on or replace any airbag system components yourself. However, you should have your vehicle inspected by a dealer in the following situations:

### ■ When the airbags have deployed

If an airbag has inflated, the control unit and other related parts must be replaced. Similarly, once an automatic seat belt tensioner has been activated, it must be replaced.

### ■ When the vehicle has been in a moderate-to-severe collision

Even if the airbags did not inflate, have your dealer inspect the following: the seat belt tensioners for the front seats and outer rear seats\*, and each seat belt that was worn during the crash.

### ✘ Airbag Care

The removal of airbag components from the vehicle is prohibited.

In case of malfunction, or shutdown, or after the airbag inflation/seat belt tensioner operation, ask a qualified personnel for handling.

We recommend against the use of salvaged airbag system components, including the airbag, tensioners, sensors, and control unit.

# Pop-up Hood System\*

## About the Pop-up Hood System

The pop-up hood system is designed to help to reduce the possible head injuries of a pedestrian if they experience a frontal impact with your vehicle.

### The System Activates When

Your vehicle strikes a pedestrian or other objects at moderate or higher speed.

### How the System Works

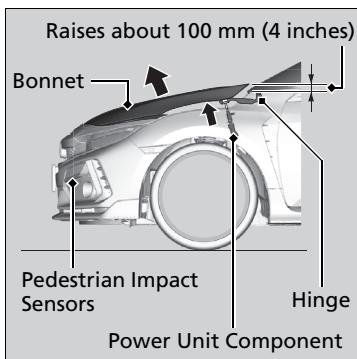

When the pedestrian impact sensors detect a certain amount of impact, the pop-up hood system is activated and the rear of the bonnet will raise.

The raised bonnet can help to reduce pedestrian head injuries.

### About the Pop-up Hood System

#### **WARNING**

After the pop-up hood is activated, the power unit components become extremely hot and can cause burns. Do not touch the power unit components until they have cooled.

#### **NOTICE**

Do not attempt to open the bonnet after the pop-up hood system has been activated. After the system activation, make sure the raised bonnet does not interfere with visibility, and then drive slowly and carefully.

If the bonnet is not fully closed, it may not work properly. Make sure the bonnet is fully closed before driving.

\* Not available on all models

The following conditions may also activate the system.

- A severe impact on the underside of your vehicle.
- Driving over speed bumps at high speed, or over a large pothole.
- When the objects impact the pedestrian impact sensors.

The system may not activate if your vehicle is:

- Impacted from the rear or side.
- Tipped over or rolled over.
- A pedestrian is struck at an angle.

Other factors, such as where, at which angle, or at what vehicle speed the impact has occurred, may prevent the pop-up hood system from activating.

#### ▣ About the Pop-up Hood System

For the pop-up hood system to work properly:

- Always use the same size tyres as the original. The system may not read your vehicle speed correctly with the different size tyres.
- Never apply force to the system's power unit. It can be damaged if you slam the bonnet shut.
- Do not impact the pedestrian impact sensors in the front bumper.

Pop-up Hood System label is found under the bonnet:

▣ **Label Locations** P. 105

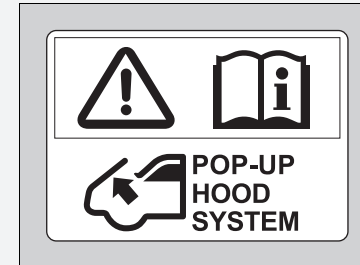



## ■ System Warning Message for Pop-up Hood



### ■ When the ignition switch is turned to ON II\*1

A system warning message appears on the driver information interface if there is a potential problem with the pop-up hood system.

## Pop-up Hood System Care

You do not need to, and should not, perform any maintenance on or replace any pop-up hood system components yourself.

However, if the pop-up hood system has ever activated, you need to have the control unit, and other related parts replaced by a dealer.

\*1: Models with the keyless access system have an **ENGINE START/STOP** button instead of an ignition switch.

## ▣ System Warning Message for Pop-up Hood

### **⚠ WARNING**

Ignoring the pop-up hood message can result in a malfunction of the pop-up hood. This can result in serious injury or death if your vehicle impacts a pedestrian.

If the pop-up hood message comes on, have your vehicle checked by a dealer as soon as possible.

## ▣ Pop-up Hood System Care

If the front bumper is damaged, have the vehicle checked by a dealer even if the pop-up hood system did not activate.

# Child Safety

## Protecting Child Passengers

Each year, many children are injured or killed in vehicle crashes because they are either unrestrained or not properly restrained. In fact, vehicle crashes are the number one cause of death of children aged 12 and under.

To reduce the number of child deaths and injuries, infants and children should be properly restrained when they ride in a vehicle.

**Children should sit properly restrained in a rear seat.** This is because:

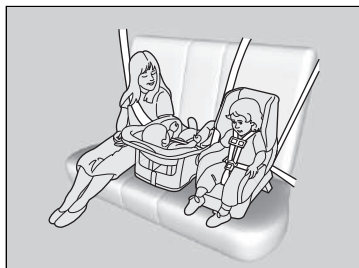

- An inflating front or side airbag can injure or kill a child sitting in the front seat.
- A child in the front seat is more likely to interfere with the driver's ability to safely control the vehicle.
- Statistics show that children of all sizes and ages are safer when they are properly restrained in a rear seat.

### Protecting Child Passengers

#### **⚠ WARNING**

**Children who are unrestrained or improperly restrained can be seriously injured or killed in a crash.**

**Any child too small for a seat belt should be properly restrained in an approved child restraint system. A larger child should be properly restrained with a seat belt, using a booster seat if necessary.**

In many countries, the law requires all children aged 12 and under, and whose height are shorter than 150 cm (60 inches) be properly restrained in a rear seat.

In many countries, it is required to use an officially approved and suitable child restraint system for transporting a child on any passenger seat. Check your local legal requirement.

We recommend that child restraint systems meet UN Regulation No. 44 or No. 129\*, or the regulations of the subject countries.

➤ **Selecting a Child Restraint System** P. 80

- Any child who is too small to wear a seat belt must be properly restrained in an approved child restraint system that is properly secured to the vehicle using the seat belt or the child restraint anchorage system.
- Never hold a child on your lap because it is impossible to protect them in the event of a collision.
- Never put a seat belt over yourself and a child. During a crash, the belt would likely press deep into the child and cause serious or fatal injuries.
- Never let two children use the same seat belt. Both children could be very seriously injured in a crash.

Protecting Child Passengers

Front Passenger's Sun Visor

**WARNING**



**NEVER** use a rearward facing child restraint on a seat protected by an **ACTIVE AIRBAG** in front of it, **DEATH** or **SERIOUS INJURY** to the **CHILD** can occur.

Models without rear fog light

Front Passenger's Doorjamb

**WARNING**



**Extreme Hazard!**  
**DO NOT** use a rear-facing child restraint on a seat protected by an airbag in front of it!

Continued

- Do not allow children to operate the doors, windows or seat adjustments.
- Do not leave children in the vehicle unattended, especially in hot weather when the inside of the vehicle can get hot enough to kill them. They could also activate vehicle controls causing it to move unexpectedly.

▣ Protecting Child Passengers

**WARNING:** Use the power window lock button to prevent children from opening the windows. Using this feature will prevent children from playing with the windows, which could expose them to hazards or distract the driver.

▣ **Opening/Closing the Power Windows**  
P. 212

**WARNING:** Always take the ignition key with you whenever you leave the vehicle alone or with other occupants.

To remind you of the passenger's front airbag hazard and child safety, your vehicle has the warning label on the passenger's side sun visor. Please read and follow the instructions on this label.

▣ **Safety Labels** P. 105

## Safety of Infants and Small Children

### ■ Protecting Infants

An infant must be properly restrained in a rear-facing, reclining child restraint system until the infant reaches the child restraint system manufacturer's weight or height limit for the seat, and the infant is at least one year old.

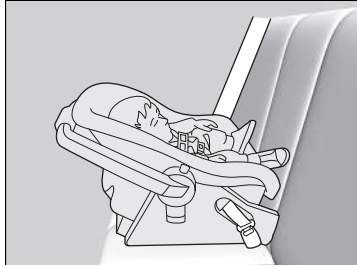

#### ■ Positioning a rear-facing child restraint system

Child restraint system must be placed and secured in a rear seating position.

- ▶ We recommend that you install the child restraint system directly behind the front passenger's seat, move the seat as far forward as needed, and leave it unoccupied.
- ▶ Make sure that there is no contact between the child restraint system and the seat in front of it. If there is, you may wish to get a smaller rear-facing child restraint system.

### ▣ Protecting Infants

#### ⚠ WARNING

Placing a rear-facing child restraint system in the front seat can result in serious injury or death if the passenger's front airbag inflates.

Always place a rear-facing child restraint system in the back seat, not the front.

As required by UN Regulation No. 94:

#### ⚠ WARNING



**NEVER** use a rearward facing child restraint on a seat protected by an **ACTIVE AIRBAG** in front of it, **DEATH** or **SERIOUS INJURY** to the **CHILD** can occur.

Many experts recommend use of a rear-facing child restraint system for a child up to two years old if the child's height and weight are appropriate for a rear-facing child restraint system.

When properly installed, a rear-facing child restraint system may prevent the driver or a front passenger from moving their seat all the way back, or from locking their seat-back in the desired position.

#### ► Protecting Infants

If the passenger's front airbag inflates, it can hit the rear-facing child restraint system with great force, which can dislodge or strike the system, and seriously injure the child.

Rear-facing child restraint systems should never be installed in a front-facing position.

Always refer to the child restraint system manufacturer's instructions before installation.

#### Models with rear fog light

If it is absolutely unavoidable to install a rear-facing child restraint system in the front passenger seat, manually turn off the passenger front airbag system.

► **Passenger Front Airbag Off System** \* P. 63

## ■ Protecting Smaller Children

If a child is at least one year old and has exceeded the weight and height limitations of a rear-facing child restraint system, the child should be properly restrained in a firmly secured front-facing child restraint system until they exceed the weight and height limitations for the front-facing child restraint system.



### ■ Front-facing child restraint system placement

We strongly recommend placing a front-facing child restraint system in a rear seating position.

Placing a front-facing child restraint system in the front seat can be hazardous. A rear seat is the safest place for a child.

## ▣ Protecting Smaller Children

### ⚠ WARNING

Placing a front-facing child restraint system in the front seat can result in serious injury or death if the front airbag inflates.

If you must place a front-facing child restraint system in front, move the vehicle seat as far back as possible, and properly restrain the child.

Educate yourself about the laws and regulations regarding child restraint system use where you are driving, and follow the child restraint system manufacturer's instructions.

## ■ Selecting a Child Restraint System

Some child restraint systems are lower anchorage compatible. Some have a rigid-type connector while others have a flexible-type connector. Both are equally easy to use. Some existing and previously owned child restraint systems can only be installed using the seat belt. Whichever type you choose, follow the child restraint system manufacturer's use and care instructions including recommended expiration dates as well as the instructions in this manual. Proper installation is key to maximising your child's safety.

The flexible type may not be available in your country.

In seating positions and vehicles not equipped with lower anchorages, install a child restraint system using the seat belt and a top tether for added security. This is because all child restraint systems must be secured with the seat belt when the lower anchorage system is not in use. In addition, the child restraint system manufacturer may advise that a seat belt be used to attach an ISO FIX restraint system once a child reaches a specified weight. Please read the child restraint system owner's manual for proper installation instructions.

### ■ Important consideration when selecting a child restraint system

Make sure the child restraint system meets the following three requirements:

- The child restraint system is the correct type and size for the child.
- The child restraint system is the correct type for the seating position.
- The child restraint system is compliant with safety standards. We recommend a child restraint system compliant with UN Regulation No. 44 or No. 129\*, or the regulations of the subject countries. Look for the approval mark on the system and the manufacturer's statement of compliance on the box.

### ☒ Selecting a Child Restraint System

Installation of a lower anchorage-compatible child restraint system is simple.

Lower anchorage-compatible child restraint systems have been developed to simplify the installation process and reduce the likelihood of injuries caused by incorrect installation.



### ■ Child Restraint Systems Standards

If a child restraint system (whether an i-Size®/ISOFIX type or one that is fitted with a seat belt) meets the relevant UN Regulation, it will be affixed with an approval label as shown in the adjacent table. Before purchasing or using any child restraint system, make sure to check the approval label and ensure that it is compatible with your vehicle and the child, and that it complies with the relevant UN Regulation.

#### ▣ Selecting a Child Restraint System

Example of UN Regulation No. 44 approval label

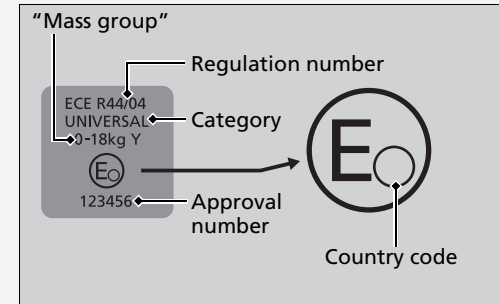

Example of UN Regulation No. 129 approval label\*

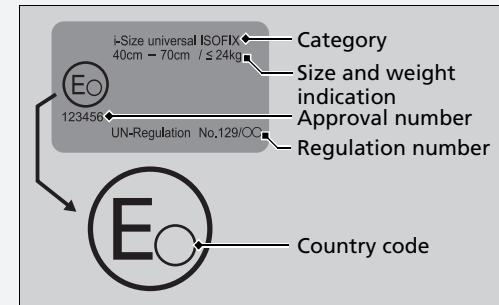

\* Not available on all models

Continued

### ■ Lower Anchorage-Compatible Child Restraint Systems

The two outer rear seats in your vehicle are equipped with lower anchorages. However, not all of the various types of child restraint systems are suitable for use in your vehicle. Before you purchase or use any lower anchorage-compatible (i-Size\*/ISOFIX) child restraint system, refer to the following tables to ensure that the restraint system is appropriate for the vehicle, the seating position, and the child's weight (mass group) and size.

#### ☒ Lower Anchorage-Compatible Child Restraint Systems

Mass group is specified for some child restraint systems. Make sure to check the mass group as indicated in the manufacturer's instructions as well as on the package and labels of the child restraint system.

The particular child restraint systems listed in the table are genuine Honda products. They are available from your dealer.

For correct installation, refer to the instructions manual that came with the child restraint system.

Except 2.0 L engine models

■ ISOFIX Child Restraint Systems

MASS Group	Size Class	Fixture	Vehicle ISOFIX positions				Recommended Child Restraint Systems*1
			Front passenger	Rear seat			
				L-Side	R-Side	Centre	
Carrycot	F	ISO/L1	—	X	X	—	
	G	ISO/L2	—	X	X	—	
group 0 up to 10 kg	E	ISO/R1	—	IL*2	IL*2	—	Honda Baby Safe ISOFIX
group 0+ up to 13 kg	E	ISO/R1	—	IL*2	IL*2	—	Honda Baby Safe ISOFIX
	D	ISO/R2	—	IL*2	IL*2	—	Honda Baby Safe ISOFIX
	C	ISO/R3	—	IL*2	IL*2	—	Honda Baby Safe ISOFIX
group I 9 to 18 kg	D	ISO/R2	—	IL	IL	—	
	C	ISO/R3	—	IL	IL	—	
	B	ISO/F2	—	IUF	IUF	—	Honda ISOFIX
	B1	ISO/F2X	—	IUF	IUF	—	Honda ISOFIX
	A	ISO/F3	—	IUF	IUF	—	Honda ISOFIX
group II 15 to 25 kg			—	X	X	—	
group III 22 to 36 kg			—	X	X	—	

▣ Lower Anchorage-Compatible Child Restraint Systems

When purchasing a child restraint systems, make sure to check the ISOFIX size class or the fixture to ensure that the seat is compatible with your vehicle.

ISOFIX Size Class	Fixture (CRF)	Description
G	ISO/L2	Right lateral-facing (carrycot) infant seat
F	ISO/L1	Left lateral-facing (carrycot) infant seat
E	ISO/R1	Rearward-facing infant seat
D	ISO/R2	Reduced-size rearward-facing child restraint systems
C	ISO/R3	Full-size rearward-facing child restraint systems
B1	ISO/F2X	Reduced-height forward-facing child restraint systems
B	ISO/F2	Reduced-height forward-facing child restraint systems
A	ISO/F3	Full-height, forward-facing child restraint systems

Continued

- \*1: The named Child Restraint Systems (CRS) reflect Honda's recommendations at the date of publication. You should speak to an authorised dealer for up-to-date information on our recommended CRSs. Other CRSs may also be suitable for use. Refer to the CRS manufacturer's list of recommended vehicles for the CRS in question.
- \*2: Honda Baby Safe ISOFIX is able to equipped for rear-facing.
- IUF: Suitable for forward-facing ISOFIX child restraints system of universal category approved for use in this mass group.
- IL: Suitable for particular ISOFIX child restraint systems (CRS), including those listed in the corresponding box in the right column of the table. These ISOFIX CRS are those of the 'specific vehicle', 'restricted' or 'semi-universal' categories.
- X: Seat position not suitable for children in this mass group.

Except 2.0 L engine models

■ i-Size Child Restraint Systems

	Seating position			
	Front seat	Rear L-side seat	Rear R-side seat	Rear centre seat
i-Size child restraint system	—	i-U	i-U	—

i-U: Suitable for forward- and rearward-facing i-Size "universal" child restraint systems.

## ■ Child Restraint Systems to be Installed with a Lap/Shoulder Seat Belt

Not all of the various types of child restraint systems are suitable for use in your vehicle. Before you purchase or use a child restraint system, refer to the following table to ensure that the child restraint system is appropriate for the vehicle, the seating position, and the child's weight (mass group) and size.

### ☒ Child Restraint Systems to be Installed with a Lap/Shoulder Seat Belt

Mass group is specified for some child restraint systems. Make sure to check the mass group as indicated in the manufacturer's instructions as well as on the package and labels of the child restraint system.

The particular child restraint systems listed in the table are genuine Honda products. They are available from your dealer.

For correct installation, refer to the instructions manual that came with the child restraint system.

*Continued*

Except 2.0 L engine models

■ Child restraint systems to be installed with a lap/shoulder seat belt

MASS Group	Seating position					Recommended Child Restraint Systems* <sup>1</sup>
	Front passenger		Rear seat			
	Passenger front airbag ON/OFF switch* position		L-Side	R-Side	Centre	
	ON	OFF				
group 0 up to 10 kg	X	U* <sup>2</sup>	U	U	U	Honda Baby Safe
group 0+ up to 13 kg	X	U* <sup>2</sup>	U	U	U	Honda Baby Safe
group I 9 to 18 kg	UF* <sup>2</sup>	U* <sup>2</sup>	U	U	U	Honda ISOFIX (Belted) Honda Eclipse
group II 15 to 25 kg	UF* <sup>2</sup>	U* <sup>2</sup>	U, L* <sup>3</sup>	U, L* <sup>3</sup>	U	Honda KID FIX XP SICT L; Honda KID FIX XP SICT with ISOFIX mounted
group III 22 to 36 kg	UF* <sup>2</sup>	U* <sup>2</sup>	U, L* <sup>3</sup>	U, L* <sup>3</sup>	U	Honda KID FIX XP SICT L; Honda KID FIX XP SICT with ISOFIX mounted

U: Suitable for “universal” category restraints approved for use in this mass group.

UF: Suitable for forward-facing “universal” category restraints approved for use in this mass group.

L: Suitable for particular child restraint systems (CRS) given in the table.

X: Seat position not suitable for children in this mass group.

\*1: The named Child Restraint Systems (CRS) reflect Honda’s recommendations at the date of publication. You should speak to an authorised dealer for up-to-date information on our recommended CRSs. Other CRSs may also be suitable for use. Refer to the CRS manufacturer’s list of recommended vehicles for the CRS in question.

\*2: Move the front seat to its slide rail rearmost and adjust the front seat-back angle to its most upright position.

\*3: Honda KID FIX XP SICT is able to equipped for front-facing.

European models (2.0 L engine)

■ Locations for Child Restraint System Installation

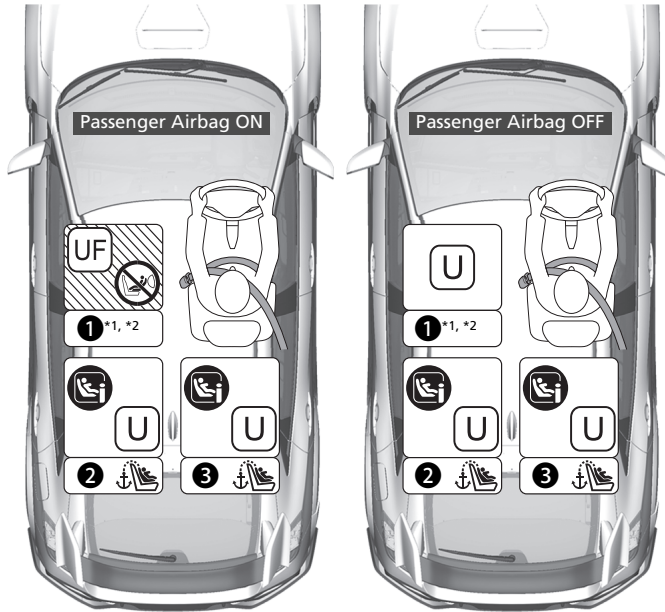

	Suitable for universal restraint systems installed with vehicle safety belts.
	Suitable for forward facing universal restraint systems installed with vehicle safety belts.
	Suitable for i-Size and ISOFIX child restraints systems.
	Suitable for forward facing restraint systems only.
	Never use a rearward facing child restraint system.
	Seat position equipped with Top Tether anchorages.

\*1: Adjust the seat slide to the rearmost position and adjust the seat back to the front lock position.

\*2: When installing a forward-facing junior seat approved by UN R129, adjust the seat slide to the rearmost position and adjust the seat back to the following position. The seat should be in the 2nd position from the foremost lock position, and the headrest should be removed. Note that the removed headrest should be stored in the luggage compartment so that it will not fly during sudden braking or collision.

The child seat with the support legs can also be attached for non i-size seating position.

Seat position number	Seating position			
	①		②	③
	Front passenger* <sup>1</sup>		2nd row	
	Front passenger airbag ON/OFF switch position		Left	Right
ON	OFF			
Seating position suitable for universal belted (YES/NO)	YES Front facing only	YES	YES	YES
i-Size seating position (YES/NO)	NO	NO	YES	YES
Seating position suitable for recommended genuine CRS* <sup>3</sup> (YES/NO)	YES Front facing only	YES	YES	YES
Seating position suitable for lateral fixture (L1/L2)	NO	NO	NO	NO
Largest suitable rearward facing fixture (R1/R2X/R2/R3)	NO	NO	R3	R3
Largest suitable forward facing fixture (F2X/F2/F3)	NO	NO	F3	F3
Largest suitable booster fixture (B2/B3)	B3* <sup>2</sup>	B3* <sup>2</sup>	B3	B3

☒ Locations for Child Restraint System Installation

When purchasing a child restraint systems, make sure to check the ISOFIX size class or the fixture to ensure that the seat is compatible with your vehicle.

Fixture (CRF)	Description
ISO/L1	Left lateral-facing (carrycot) infant seat
ISO/L2	Right lateral-facing (carrycot) infant seat
ISO/R1	Rearward-facing infant seat
ISO/R2X	Reduced-size rearward-facing child restraint systems
ISO/R2	Reduced-size rearward-facing child restraint systems
ISO/R3	Full-size rearward-facing child restraint systems
ISO/F2X	Reduced-height forward-facing child restraint systems
ISO/F2	Reduced-height forward-facing child restraint systems
ISO/F3	Full-height, forward-facing child restraint systems
ISO/B2	Reduced width forward-facing booster seat
ISO/B3	Full width forward-facing booster seat



- \*1: Adjust the seat slide to the rearmost position and adjust the seat back to the front lock position.
- \*2: When installing a forward-facing junior seat approved by UN R129, adjust the seat slide to the rearmost position and adjust the seat back to the following position. The seat should be in the 2nd position from the foremost lock position, and the headrest should be removed. Note that the removed headrest should be stored in the luggage compartment so that it will not fly during sudden braking or collision.
- \*3: The named Child Restraint Systems (CRS) reflect Honda's recommendations at the date of publication. You should speak to an authorised dealer for up to date details relating to our recommended CRSs. Other CRS may also be suitable - please consult CRS manufacturers for recommended vehicle lists.

The child seat with the support legs can also be attached for non i-size seating position.

■ Europe Genuine CRS List

**R44**

Mass Group	Child Restraint System	Category
Group 0 up to 10 kg	—	—
Group 0+ up to 13 kg	—	—
Group I 9 to 18 kg	—	—
Group II, III 15 to 36 kg	Honda KIDFIX XP SICT	Universal Semi-universal

**R129**

Range of application	Child Restraint System	Category
40 to 83 cm up to 13 kg (Birth - 15 months)	Honda baby safe	Infant carrier module
	Honda baby safe ISOFIX	Base for i-Size
76 to 105 cm 8 to 22 kg (15 months - 4 years)	Honda ISOFIX	i-Size Universal ISOFIX

## ■ Installing a Lower Anchorage-Compatible Child Restraint System

A lower anchorage-compatible child restraint system can be installed in either of the two outer rear seats. A child restraint system is attached to the lower anchorages with either the rigid or flexible type of connectors.

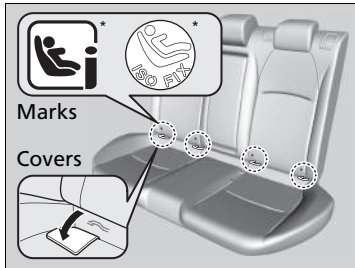

1. Locate the anchor marks affixed to the base of the seat cushion.
2. Pull out the anchor covers under the marks to expose the lower anchorages.

## ▶▶ Installing a Lower Anchorage-Compatible Child Restraint System

### ⚠ WARNING

Never attach two child restraint systems to the same anchor. In a collision, one anchor may not be strong enough to hold two child restraint system attachments and may break, causing serious injury or death.

Some child restraint systems come with optional guide-cups, which avoid possible damage to the seat surface. Follow the manufacturer's instructions when using the guide-cups, and attach them to the lower anchorages as shown in the image.

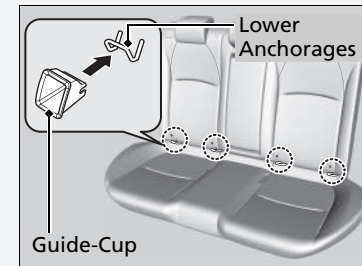

\* Not available on all models

Continued

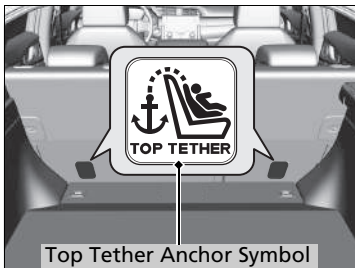
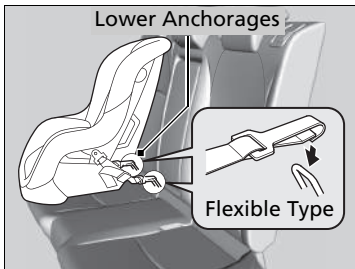
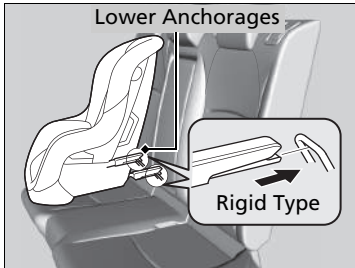

3. Place the child restraint system on the vehicle seat, then attach the child restraint system to the lower anchorages according to the instructions that came with the child restraint system.

► When installing the child restraint system, make sure that the lower anchorages are not obstructed by the seat belt or any other object.

✎ Installing a Lower Anchorage-Compatible Child Restraint System

**WARNING:** Never use a hook that does not come with a Top Tether anchor symbol when securing an installed child restraint system.

For your child's safety, when using a child restraint system installed using the lower anchorage system, make sure that the child restraint system is properly secured to the vehicle. A child restraint system that is not properly secured will not adequately protect a child in a crash and may cause injury to the child or other vehicle occupants.

The flexible type may not be available in your country.

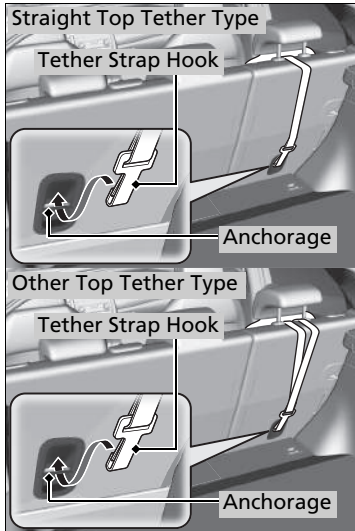

Except 2.0 L engine models

Child restraint system with tether strap

4. Raise the head restraint to its highest position.

Models with luggage area cover

- Retract the luggage area cover.

► **Luggage Area Cover\*** P. 266

5. Route the tether strap between the head restraint legs, and secure the tether strap hook to the anchorage.
  - Make sure the strap is not twisted.
6. Tighten the tether strap as instructed by the child restraint system manufacturer.
7. Make sure the child restraint system is firmly secured by rocking it forward and back, and side to side; little movement should be felt.
8. Make sure any unused seat belt that a child can reach is buckled.

\* Not available on all models

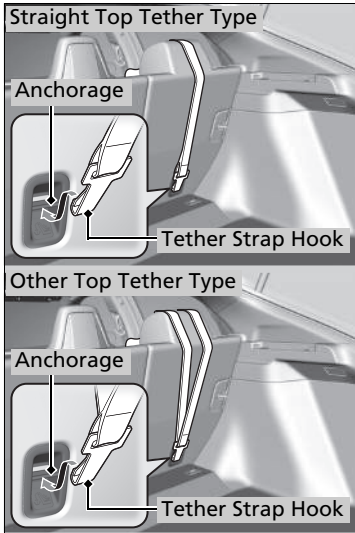

**2.0 L engine models**

**Child restraint system with tether strap**

**Models with luggage area cover**

4. Retract the luggage area cover.
  - **Luggage Area Cover\*** P. 266
5. Route the tether strap over the head restraint.
  - Make sure the strap is not twisted.
6. Tighten the tether strap as instructed by the child restraint system manufacturer.
7. Make sure the child restraint system is firmly secured by rocking it forward and back, and side to side; little movement should be felt.
8. Make sure any unused seat belt that a child can reach is buckled.



**Models with rear fog light**

**Child restraint system with support leg**

4. Extend the support leg until it touches the floor as instructed by the child restraint system manufacturer.
  - Confirm that the section of the floor on which the support leg rests is level. If the section is not level, the support leg will not provide adequate support.
  - Make sure that there is no contact between the child restraint system and the seat in front of it.

### ■ Installing a Child Restraint System with a Lap/Shoulder Seat Belt

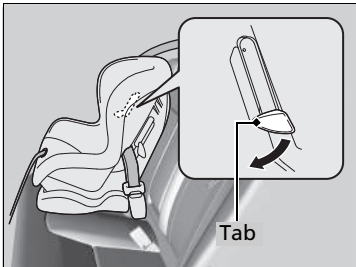
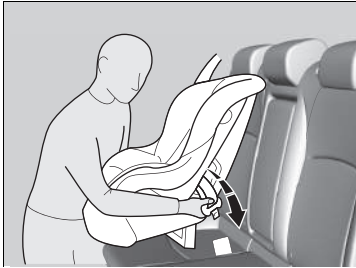

1. Place the child restraint system on the vehicle seat.
2. Route the seat belt through the child restraint system according to the child restraint system manufacturer's instructions, and insert the latch plate into the buckle.
  - Insert the latch plate fully until it clicks.
3. Push down the tab. Route the shoulder part of the belt into the slit at the side of the restraint.
4. Grab the shoulder part of the belt near the buckle, and pull up to remove any slack from the lap part of the belt.
  - When doing this, place your weight on the child restraint system and push it into the vehicle seat.
5. Position the belt properly and push up the tab. Make sure the belt is not twisted.
  - When pushing up the tab, pull up the upper shoulder part of the belt to remove any slack from the belt.

### ▣ Installing a Child Restraint System with a Lap/Shoulder Seat Belt

A child restraint system that is not properly secured will not adequately protect a child in a crash and may cause injury to the child or other vehicle occupants.



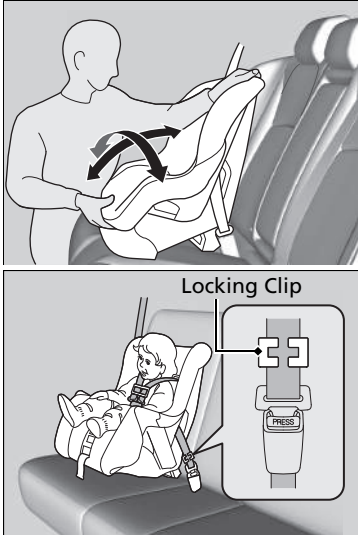

6. Make sure the child restraint system is firmly secured by rocking it forward and back, and side to side; little movement should be felt.
7. Make sure any unused seat belt that a child can reach is buckled.

If your child restraint system does not come with a mechanism that secures the belt, install a locking clip on the seat belt.

After going through the steps 1 and 2, pull up the shoulder part of the belt and make sure there is no slack in the lap portion.

3. Tightly grasp the belt near the latch plate. Pinch both parts of the belt together so they do not slip through the latch plate. Unbuckle the seat belt.
4. Install the locking clip as shown in the image. Position the clip as close as possible to the latch plate.
5. Insert the latch plate into the buckle. Go to steps 6 and 7.

## ■ Adding Security with a Tether

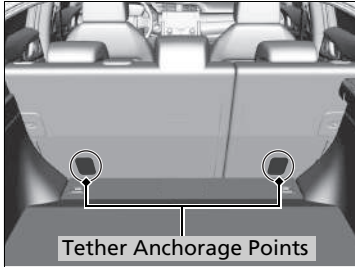

A tether anchorage point is provided behind each rear outer seating position. If you have a child restraint system that comes with a tether but can be installed with a seat belt, the tether may be used for additional security.

1. Locate the appropriate tether anchorage point.

### Models with luggage area cover

- Retract the luggage area cover.
  - **Luggage Area Cover\*** P. 266

## ➤ Adding Security with a Tether

**WARNING:** Child restraint anchorages are designed to withstand only those loads imposed by correctly fitted child restraints. Under no circumstances are they to be used for adult seat belts, harnesses or for attaching other items or equipment to the vehicle.

Always use a tether for front-facing child restraint system when using the seat belt or lower anchorages.

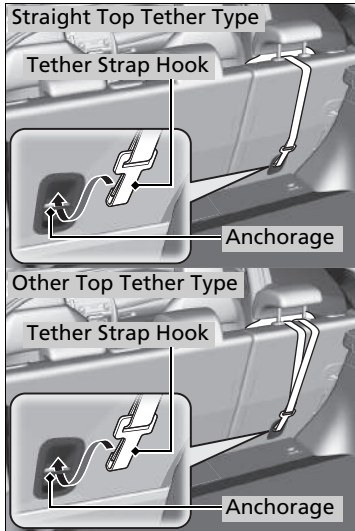

Except 2.0 L engine models

2. Raise the head restraint to its highest position, then route the tether strap between the head restraint legs. Make sure the strap is not twisted.
3. Secure the tether strap hook to the anchorage.
4. Tighten the tether strap as instructed by the child restraint system manufacturer.

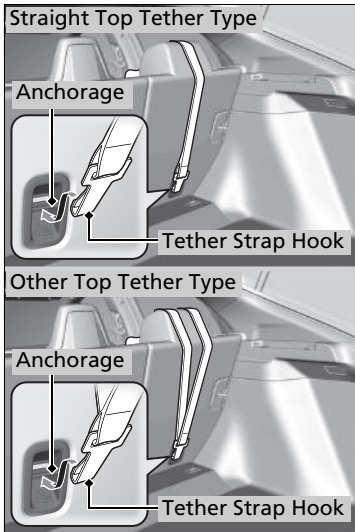

**2.0 L engine models**

2. Route the tether strap over the head restraint. Make sure the strap is not twisted.
3. Secure the tether strap hook to the anchorage.
4. Tighten the tether strap as instructed by the child restraint system manufacturer.

## Safety of Larger Children

### ■ Protecting Larger Children

The following pages give instructions on how to check proper seat belt fit, what kind of booster seat to use if one is needed, and important precautions for a child who must sit in front.

### ■ Checking Seat Belt Fit

When a child is too big for a child restraint system, secure the child in a rear seat using the lap/shoulder seat belt. Have the child sit upright and all the way back, then answer the following questions.



#### ■ Checklist

- Do the child's knees bend comfortably over the edge of the seat?
- Does the shoulder belt cross between the child's neck and arm?
- Is the lap part of the seat belt as low as possible, touching the child's thighs?
- Will the child be able to stay seated like this for the whole trip?

If you answer yes to all these questions, the child is ready to wear the lap/shoulder seat belt correctly. If you answer no to any question, the child needs to ride on a booster seat until the seat belt fits properly without a booster seat.

### ▶▶ Safety of Larger Children

## ⚠ WARNING

Allowing a child aged 12 or under to sit in front can result in injury or death if the passenger's front airbag inflates.

If a larger child must ride in front, move the vehicle seat as far to the rear as possible, have the child sit up properly and wear the seat belt properly, using a booster seat if needed.

*Continued*

## Booster Seats



If a lap/shoulder seat belt cannot be used properly, position the child in a booster seat in the rear seat. For the child's safety, check that the child meets the booster seat manufacturer's recommendations.

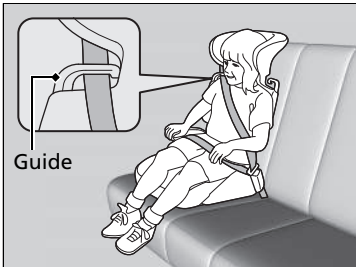

A backrest is available for a specific booster seat. Install the backrest to the booster seat and adjust it to the vehicle seat according to the booster seat manufacturer's instructions. Make sure the seat belt is properly routed through the guide at the shoulder of the backrest and the belt does not touch and cross the child's neck.

## Booster Seats

When installing a booster seat, make sure to read the instructions that came with it, and install the seat accordingly.

There are high- and low-type booster seats. Choose a booster seat that allows the child to wear the seat belt correctly.

We recommend a booster seat with a backrest as it is easier to adjust the shoulder belt.

## ■ Protecting Larger Children - Final Checks

Your vehicle has a rear seat where children can be properly restrained. If you ever have to carry a group of children, and a child must ride in front:

- Make sure you read and fully understand the instructions and safety information in this manual.
- Move the front passenger seat as far back as possible.
- Have the child sit upright and well back in the seat.
- Check that the seat belt is properly positioned so that the child is secure in the seat.

### ■ Monitoring child passengers

We strongly recommend that you keep an eye on child passengers. Even older, more mature children sometimes need to be reminded to fasten their seat belts and sit up properly.

# Exhaust Gas Hazard

## Carbon Monoxide Gas

The engine exhaust from this vehicle contains carbon monoxide, a colourless, odourless, and highly toxic gas. As long as you properly maintain your vehicle, carbon monoxide gas will not get into the interior.

### ■ Have the exhaust system inspected for leaks whenever

- The exhaust system is making an unusual noise.
- The exhaust system may have been damaged.
- The vehicle is raised for an oil change.

When you operate a vehicle with the hatch open, airflow can pull exhaust gas into the interior and create a hazardous condition. If you must drive with the hatch open, open all the windows and set the heating system\*/climate control system\* as shown below.

1. Select the fresh air mode.
2. Select the  mode.
3. Set the fan speed to high.
4. Set the temperature control to a comfortable setting.

Adjust the heating system\*/climate control system\* in the same manner if you sit in your parked vehicle with the engine running.

### ☒ Carbon Monoxide Gas

## WARNING

Carbon monoxide gas is toxic.

Breathing it can cause unconsciousness and even kill you.

Avoid any enclosed areas or activities that expose you to carbon monoxide.

An enclosed area such as a garage can quickly fill up with carbon monoxide gas. Do not run the engine with the garage door closed. Even when the garage door is open, drive out of the garage immediately after starting the engine.



# Safety Labels

## Label Locations

These labels are in the locations shown. They warn you of potential hazards that can cause serious injury or death. Read these labels carefully.

If a label comes off or becomes hard to read, contact a dealer for a replacement.

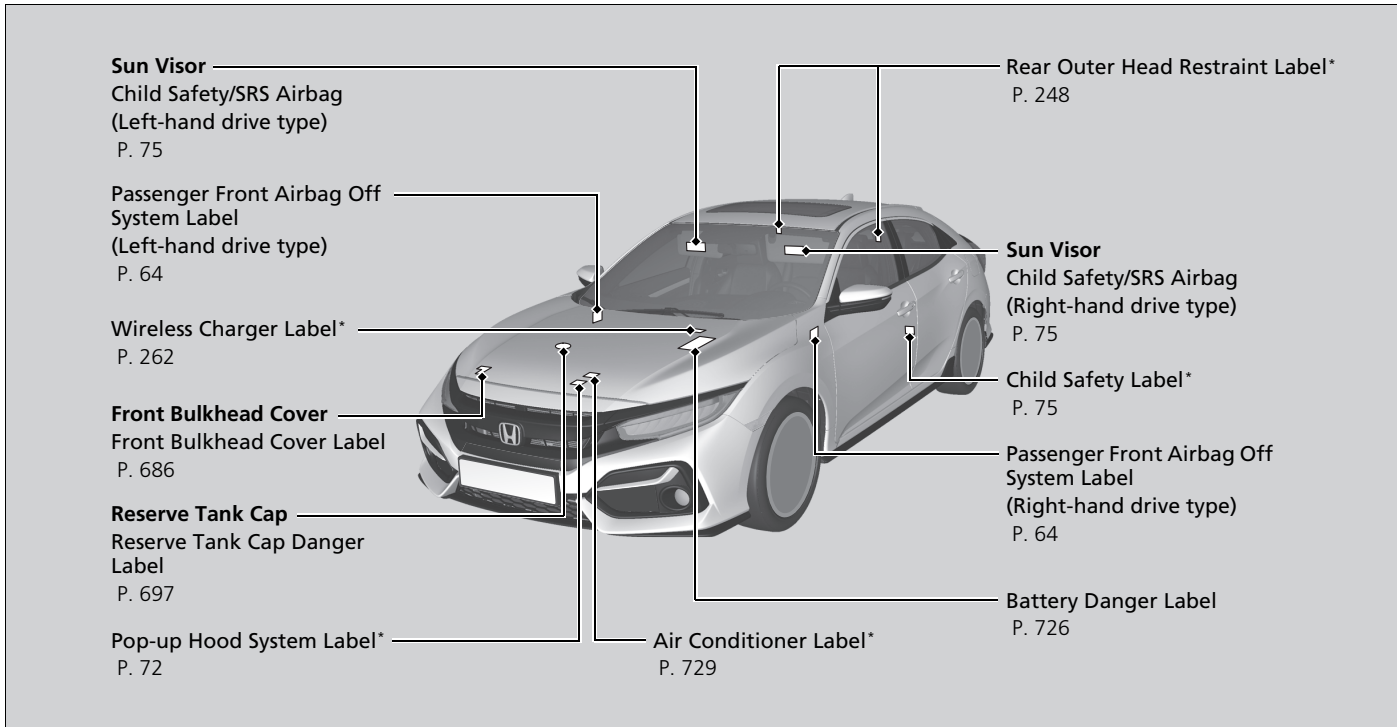

\* Not available on all models



# Instrument Panel

This chapter describes the buttons, indicators, and gauges that are used while driving.



## **Indicators**







Driver Information Interface Warning and  
Information Messages..... 135

## **Gauges and Driver Information Interface**





Gauges..... 159

Driver Information Interface ..... 161









# Indicators

Indicator	Name	On/Blinking	Explanation	Message
 (Red)	Parking Brake and Brake System Indicator (Red)	<ul style="list-style-type: none"> <li>Comes on for a few seconds when you turn the ignition switch to ON *1, then goes off if the parking brake has been released.</li> <li>Comes on when the parking brake is applied, and goes off when it is released.</li> <li>Comes on when the brake fluid level is low.</li> <li>Comes on if there is a problem with the brake system.</li> <li>The beeper sounds and the indicator comes on if you drive with the parking brake not fully released.</li> </ul>	<ul style="list-style-type: none"> <li><b>Comes on while driving</b> - Make sure the parking brake is released. Check the brake fluid level.               <ul style="list-style-type: none"> <li> <b>What to do it comes on while driving</b> P. 784</li> </ul> </li> <li><b>Comes on along with the ABS indicator</b> - Have your vehicle checked by a dealer.               <ul style="list-style-type: none"> <li> <b>If the Brake System Indicator (Red) Comes On or Blinks</b> P. 784</li> </ul> </li> </ul> <p><b>1.0 L engine models</b></p> <ul style="list-style-type: none"> <li><b>Comes on along with the parking brake and brake system indicator (amber)</b> - Immediately stop in a safe place. Contact a dealer for repair. The brake pedal becomes harder to operate. Depress the pedal further than you normally do.</li> </ul>	  







\*1: Models with the keyless access system have an **ENGINE START/STOP** button instead of an ignition switch.

Indicator	Name	On/Blinking	Explanation	Message
 (Red)	Parking Brake and Brake System Indicator (Red)	<ul style="list-style-type: none"> <li>Comes on for several seconds when you apply the electric parking brake while the ignition switch is in LOCK [0]*1, then goes off.</li> <li>Stays on for several seconds when you turn the ignition switch to LOCK [0]*1 while the electric parking brake is applied, then goes off.</li> </ul>	<ul style="list-style-type: none"> <li><b>Blinks and the parking brake and brake system indicator (amber) comes on at the same time</b> - There is a problem with the electric parking brake system. The parking brake may not be set. Avoid using the parking brake and have your vehicle checked by a dealer immediately.  <ul style="list-style-type: none"> <li>➤ <b>If the Brake System Indicator (Red) comes on or blinks at the same time when the Brake System Indicator (Amber) comes on</b> P. 785</li> </ul> </li> </ul>	—
	Automatic Brake Hold System Indicator	<ul style="list-style-type: none"> <li>Comes on for a few seconds when you turn the ignition switch to ON [II]*1, then goes off.</li> <li>Comes on when the automatic brake hold system is on.</li> </ul>	<ul style="list-style-type: none"> <li>➤ <b>Automatic Brake Hold</b> P. 636</li> </ul>	
	Automatic Brake Hold Indicator	<ul style="list-style-type: none"> <li>Comes on for a few seconds when you turn the ignition switch to ON [II]*1, then goes off.</li> <li>Comes on when the automatic brake hold is activated.</li> </ul>	<ul style="list-style-type: none"> <li>➤ <b>Automatic Brake Hold</b> P. 636</li> </ul>	—

\*1: Models with the keyless access system have an **ENGINE START/STOP** button instead of an ignition switch.





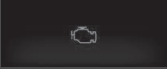









Indicator	Name	On/Blinking	Explanation	Message
 (Amber)	Parking Brake and Brake System Indicator (Amber)	<ul style="list-style-type: none"> <li>Comes on for a few seconds when you turn the ignition switch to ON *1, then goes off.</li> <li>Comes on if there is a problem with a system related to braking other than the conventional brake system.</li> <li>Comes on if there is a problem with the electric parking brake system and/or the automatic brake hold system.</li> </ul>	<ul style="list-style-type: none"> <li><b>Comes on while driving</b> - Have your vehicle checked by a dealer.  <b>Except 1.0 L engine models</b></li> <li>With this indicator on, your vehicle still has normal braking ability.  <b>1.0 L engine models</b></li> <li><b>Comes on while driving</b> - Avoid using the parking brake and have your vehicle checked by a dealer immediately.</li> </ul>	    1.0 L engine models 
		<b>Models with CMBS</b> <ul style="list-style-type: none"> <li>Comes on if there is a problem with the radar sensor.</li> <li>Indicator may come on temporarily when the maximum permissible weight is exceeded.</li> </ul>	<ul style="list-style-type: none"> <li>Make sure the total load is within the maximum permissible weight.   <b>Load Limit</b> P. 487</li> <li><b>Stays on constantly</b> - Have your vehicle checked by a dealer.</li> </ul>	

\*1: Models with the keyless access system have an **ENGINE START/STOP** button instead of an ignition switch.

Indicator	Name	On/Blinking	Explanation	Message
	Low Oil Pressure Indicator	<ul style="list-style-type: none"> <li>• Comes on when you turn the ignition switch to ON *1, and goes off when the engine starts.</li> <li>• Comes on when the engine oil pressure is low.</li> </ul>	<ul style="list-style-type: none"> <li>• <b>Comes on while driving</b> - Immediately stop in a safe place.                             <ul style="list-style-type: none"> <li>▶ <b>If the Low Oil Pressure Indicator Comes On</b> P. 782</li> </ul> </li> </ul>	
	Malfunction Indicator Lamp	<p><b>Except 1.5 L engine models</b></p> <ul style="list-style-type: none"> <li>• Comes on when you turn the ignition switch to ON *1, and goes off when the engine starts.</li> </ul> <p><b>1.5 L engine models</b></p> <ul style="list-style-type: none"> <li>• Comes on when you turn the ignition switch to ON *1, and goes off either when the engine starts, or after several seconds if the engine did not start.</li> <li>• Comes on if there is a problem with the emissions control systems.</li> <li>• Blinks when a misfire in the engine's cylinders is detected.</li> </ul>	<ul style="list-style-type: none"> <li>• <b>Comes on while driving</b> - Have your vehicle checked by a dealer.</li> <li>• <b>Blinks while driving</b> - Stop in a safe place where there are no flammable objects. Stop the engine for 10 minutes or more, and wait for it to cool down. Then, take your vehicle to a dealer.                             <ul style="list-style-type: none"> <li>▶ <b>If the Malfunction Indicator Lamp Comes On or Blinks</b> P. 783</li> </ul> </li> </ul>	

\*1: Models with the keyless access system have an **ENGINE START/STOP** button instead of an ignition switch.

►► Indicators ►









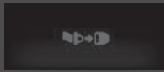

Indicator	Name	On/Blinking	Explanation	Message
	Charging System Indicator	<ul style="list-style-type: none"> <li>Comes on when you turn the ignition switch to ON <sup>*1</sup>, and goes off when the engine starts.</li> <li>Comes on when the battery is not charging.</li> </ul>	<ul style="list-style-type: none"> <li><b>Comes on while driving</b> - Turn off the automatic heating system*/climate control system* and rear demister in order to reduce electricity consumption.   <b>If the Charging System Indicator Comes On</b> P. 782</li> </ul>	
	Shift Lever Position Indicator*	<ul style="list-style-type: none"> <li>Indicates the current shift lever position.</li> </ul>	 <b>Shifting</b> P. 502, 504	—
	Transmission System Indicator*	<ul style="list-style-type: none"> <li>Blinks if the transmission system has a problem.</li> </ul>	<ul style="list-style-type: none"> <li><b>Blinks while driving</b> - Avoid sudden starts and acceleration and have your vehicle checked by a dealer immediately.</li> </ul>	
	Shift Up Indicator*	<ul style="list-style-type: none"> <li>Comes on when shifting up is recommended.</li> </ul>	 <b>Shift Up/Down* Indicators</b> P. 508	—
	Shift Down Indicator*	<ul style="list-style-type: none"> <li>Comes on when shifting down is recommended.</li> </ul>	 <b>Shift Up/Down* Indicators</b> P. 508	—
	M (7-speed manual shift mode) Indicator/Shift Indicator*	<ul style="list-style-type: none"> <li>Comes on when 7-speed manual shift mode is applied.</li> </ul>	 <b>7-Speed Manual Shift Mode</b> P. 506	—

\*1:Models with the keyless access system have an **ENGINE START/STOP** button instead of an ignition switch.









Indicator	Name	On/Blinking	Explanation	Message
	Gear Position Indicator*	<ul style="list-style-type: none"> <li>Indicates 1st to 6th gear position.</li> </ul>	<ul style="list-style-type: none"> <li>If you shift gears very slowly, a different gear position may be displayed for a moment.                             <ul style="list-style-type: none"> <li>➤ <b>Shifting</b> P. 509</li> </ul> </li> <li>Under the following conditions, gear positions are not displayed.                             <ul style="list-style-type: none"> <li>- The vehicle is stopped.</li> <li>- The select lever is in <b>R</b> position.</li> <li>- The select lever is in <b>N</b> position.</li> </ul> </li> <li>The display can be turned ON/OFF in customized features in driver information interface or audio/information screen.                             <ul style="list-style-type: none"> <li>➤ <b>Customized Features</b> P. 171, 396</li> </ul> </li> </ul>	—

\* Not available on all models

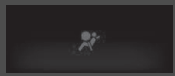
Indicator	Name	On/Blinking	Explanation	Message
	Seat Belt Reminder Indicator	<ul style="list-style-type: none"> <li>Comes on if you are not wearing a seat belt when you turn the ignition switch to ON *1.</li> </ul> <p><b>Models with rear fog light</b></p> <ul style="list-style-type: none"> <li>If the front passenger is not wearing a seat belt, the indicator comes on a few seconds later.</li> </ul> <p><b>All models</b></p> <ul style="list-style-type: none"> <li>Blinks while driving if either you and/or the front passenger* has not fastened a seat belt. The beeper sounds and the indicator blinks at regular intervals.</li> </ul>	<ul style="list-style-type: none"> <li>The beeper stops and the indicator goes off when you and the front passenger* fasten their seat belts.</li> <li><b>Stays on after you and/or the front passenger has fastened the seat belt(s)</b> - A detection error may have occurred in the sensor. Have your vehicle checked by a dealer. <ul style="list-style-type: none"> <li> <b>Seat Belt Reminder</b> P. 49</li> </ul> </li> </ul>	 
	Low Fuel Indicator	<ul style="list-style-type: none"> <li>Comes on when the fuel reserve is running low (approximately 7.0 litres/ 1.54 Imp gal left).</li> <li>Blinks if there is a problem with the fuel gauge.</li> </ul>	<ul style="list-style-type: none"> <li><b>Comes on</b> - Refuel your vehicle as soon as possible.</li> <li><b>Blinks</b> - Have your vehicle checked by a dealer.</li> </ul>	 
	Anti-lock Brake System (ABS) Indicator	<ul style="list-style-type: none"> <li>Comes on for a few seconds when you turn the ignition switch to ON *1, then goes off.</li> <li>Comes on if there is a problem with the ABS.</li> </ul>	<ul style="list-style-type: none"> <li><b>Stays on constantly</b> - Have your vehicle checked by a dealer. With this indicator on, your vehicle still has normal braking ability but no anti-lock function. <ul style="list-style-type: none"> <li> <b>Anti-lock Brake System (ABS)</b> P. 639</li> </ul> </li> </ul>	





\*1: Models with the keyless access system have an **ENGINE START/STOP** button instead of an ignition switch.

Indicator	Name	On/Blinking	Explanation	Message
	Supplemental Restraint System Indicator	<ul style="list-style-type: none"> <li>• Comes on for a few seconds when you turn the ignition switch to ON *1, then goes off.</li> <li>• Comes on if a problem with any of the following is detected:                             <ul style="list-style-type: none"> <li>- Supplemental restraint system</li> <li>- Side airbag system</li> <li>- Side curtain airbag system</li> <li>- Seat belt tensioner</li> </ul> </li> </ul>	<ul style="list-style-type: none"> <li>• <b>Stays on constantly or does not come on at all</b> - Have your vehicle checked by a dealer.</li> </ul>	
	Passenger Front Airbag On/Off Indicators*	<ul style="list-style-type: none"> <li>• Both indicators come on for a few seconds when you turn the ignition switch to ON *1, then goes off after a system check up. When the passenger front airbag is active: The on indicator comes back on and remains on for about 60 seconds. When the passenger front airbag is inactive: The off indicator comes back on and stays on. This is a reminder that the passenger front airbag is deactivated.</li> </ul>	<ul style="list-style-type: none"> <li>▣ <b>Passenger Front Airbag Off System*</b> P. 63</li> </ul>	











\*1: Models with the keyless access system have an **ENGINE START/STOP** button instead of an ignition switch.

\* Not available on all models

►► Indicators ►



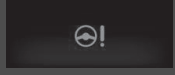



Indicator	Name	On/Blinking	Explanation	Message
	Vehicle Stability Assist (VSA) System Indicator	<ul style="list-style-type: none"> <li>Comes on for a few seconds when you turn the ignition switch to ON *1, then goes off.</li> <li>Blinks when VSA is active.</li> <li>Comes on if there is a problem with the VSA system, brake assist system, starting assist brake function* or hill start assist system.</li> </ul>	<ul style="list-style-type: none"> <li><b>Stays on constantly</b> - Have your vehicle checked by a dealer.   <b>Vehicle Stability Assist (VSA) System</b>                      P. 544</li> </ul>	
		<ul style="list-style-type: none"> <li>Comes on if the VSA system is deactivated temporarily after the battery has been disconnected, then re-connected.</li> </ul>	<ul style="list-style-type: none"> <li>Drive a short distance at more than 20 km/h (12 mph). The indicator should go off. If it does not, have your vehicle checked by a dealer.</li> </ul>	

\*1: Models with the keyless access system have an **ENGINE START/STOP** button instead of an ignition switch.



Indicator	Name	On/Blinking	Explanation	Message
	Vehicle Stability Assist (VSA) OFF Indicator	<ul style="list-style-type: none"> <li>Comes on for a few seconds when you turn the ignition switch to ON *1, then goes off.</li> <li>Comes on when you partially disable VSA.</li> </ul>	<p>➤ <b>VSA On and Off</b> P. 545</p>	
		<p><b>2.0 L engine models</b></p> <ul style="list-style-type: none"> <li>Comes on when you press and hold the  (VSA OFF) button while <b>+R</b> mode is selected.</li> </ul>	<p>➤ <b>When the drive mode is in +R mode</b> P. 546</p>	
		<ul style="list-style-type: none"> <li>Comes on if the VSA system is deactivated temporarily after the battery has been disconnected, then re-connected.</li> </ul>	<ul style="list-style-type: none"> <li>Drive a short distance at more than 20 km/h (12 mph). The indicator should go off. If it does not, have your vehicle checked by a dealer.</li> </ul>	
	Electric Power Steering (EPS) System Indicator	<ul style="list-style-type: none"> <li>Comes on when you turn the ignition switch to ON *1, and goes off when the engine starts.</li> <li>Comes on if there is a problem with the EPS System.</li> </ul>	<ul style="list-style-type: none"> <li><b>Stays on constantly or does not come on at all</b> - Have your vehicle checked by a dealer.</li> <li>➤ <b>If the Electric Power Steering (EPS) System Indicator Comes On</b> P. 786</li> </ul>	
	Adaptive Damper System Indicator*	<ul style="list-style-type: none"> <li>Comes on when the Dynamic Mode is on.</li> </ul>	<p>➤ <b>Adaptive Damper System</b>* P. 528</p>	

\*1: Models with the keyless access system have an **ENGINE START/STOP** button instead of an ignition switch.

\* Not available on all models



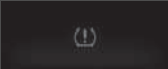

Indicator	Name	On/Blinking	Explanation	Message
	<p>Models with rear fog light</p> <p>Low Tyre Pressure/Deflation Warning System Indicator</p>	<ul style="list-style-type: none"> <li>Comes on for a few seconds when you turn the ignition switch to ON *1, then goes off.</li> <li>May come on briefly if the ignition switch is turned to ON *1 and the vehicle is not moved within 45 seconds, to indicate the calibration process is not yet complete.</li> <li>Comes on and stays on when:                             <ul style="list-style-type: none"> <li>One or more tyres' pressures are determined to be significantly low.</li> <li>The system has not been initialised.</li> </ul> </li> </ul>	<ul style="list-style-type: none"> <li><b>Comes on while driving</b> - Stop in a safe place, check tyre pressures, and inflate the tyre(s) if necessary.</li> <li><b>Stays on after the tyres are inflated to the recommended pressures</b> - The system needs to be initialised.                             <ul style="list-style-type: none"> <li> <b>Deflation Warning System Initialisation</b> P. 550</li> </ul> </li> </ul>	
		<ul style="list-style-type: none"> <li>Blinks for about one minute, and then stays on if there is a problem with the deflation warning system, or when a compact spare tyre* is temporarily installed.</li> </ul>	<ul style="list-style-type: none"> <li><b>Blinks and remains on</b> - Have your vehicle checked by a dealer. If the vehicle is fitted with a compact spare tyre, get your regular tyre repaired or replaced and put back on your vehicle as soon as you can.</li> </ul>	
		<ul style="list-style-type: none"> <li>Comes on if the deflation warning system is deactivated temporarily after the battery has been disconnected, then re-connected.</li> </ul>	<ul style="list-style-type: none"> <li>Drive a short distance at more than 20 km/h (12 mph). The indicator should go off. If it does not, have your vehicle checked by a dealer.</li> </ul>	

\*1: Models with the keyless access system have an **ENGINE START/STOP** button instead of an ignition switch.



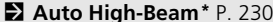

Indicator	Name	On/Blinking	Explanation	Message
	<div data-bbox="319 551 475 602" style="background-color: #333; color: white; padding: 2px;">Models without rear fog light</div> Deflation Warning System Indicator	<ul style="list-style-type: none"> <li>• Comes on for a few seconds when you set the power mode to ON, then goes off.</li> <li>• Comes on if the tyre pressure of any of the tyres becomes low.</li> <li>• Comes on when a compact spare tyre* is temporarily installed.</li> </ul>	<ul style="list-style-type: none"> <li>• <b>Comes on or blinks while driving</b> - Stop in a safe place, check which tyre's pressure is low, and find the cause.                             <ul style="list-style-type: none"> <li>▣ <b>If the Low Tyre Pressure/Deflation Warning System Indicator Comes On or Blinks</b> P. 787</li> </ul> </li> <li>• <b>Stays on after the tyres are inflated to the recommended pressures</b> - The system needs to be initialised.                             <ul style="list-style-type: none"> <li>▣ <b>Deflation Warning System Initialisation</b> P. 550</li> </ul> </li> <li>• If the vehicle is fitted with a compact spare tyre, get your regular tyre repaired or replaced and put back on your vehicle as soon as you can.</li> </ul>	
		<ul style="list-style-type: none"> <li>• Blinks for about one minute, and then stays on if there is a problem with the deflation warning system.</li> </ul>	<ul style="list-style-type: none"> <li>• <b>Blinks and remains on</b> - Have your vehicle checked by a dealer.</li> </ul>	
		<ul style="list-style-type: none"> <li>• Comes on if the deflation warning system is deactivated temporarily after the battery has been disconnected, then re-connected.</li> </ul>	<ul style="list-style-type: none"> <li>• Drive a short distance at more than 20 km/h. The indicator should go off. If it does not, have your vehicle checked by a dealer.</li> </ul>	

\* Not available on all models







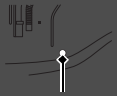

►► Indicators ►

Indicator	Name	On/Blinking	Explanation	Message
	System Message Indicator	<ul style="list-style-type: none"> <li>Comes on along with a beep when a problem is detected. A system message on the driver information interface appears at the same time.</li> </ul>	<ul style="list-style-type: none"> <li>While the indicator is on, press the  (display/information) button to see the message again.</li> <li>Refer to the Indicators information in this chapter when a system message appears on the driver information interface. Respond to the message accordingly.</li> <li>The driver information interface does not return to the normal screen unless the warning is cancelled, or the  button is pressed.</li> </ul>	—
	Auto High-Beam Indicator*	<ul style="list-style-type: none"> <li>Comes on when all the operating conditions of the auto high-beam are met.</li> </ul>	 <b>Auto High-Beam</b> * P. 230	—









Indicator	Name	On/Blinking	Explanation	Message
	Turn Signal and Hazard Warning Indicators	<ul style="list-style-type: none"> <li>• Blinks when you operate the turn signal lever.</li> <li>• Blink along with all turn signals when you press the hazard warning button.</li> </ul>	<ul style="list-style-type: none"> <li>• <b>Does not blink or blinks rapidly</b>  <ul style="list-style-type: none"> <li>▶ Replacing Light Bulbs P. 702</li> </ul> </li> </ul>	—
		<p><b>Except 2.0 L engine models</b></p> <ul style="list-style-type: none"> <li>• Blink along with all turn signals when you depress the brake pedal while the high speed driving.</li> </ul>	<ul style="list-style-type: none"> <li>• <b>Emergency Stop Signal</b> P. 641</li> </ul>	
	High Beam Indicator	<ul style="list-style-type: none"> <li>• Comes on when the high beam headlights are on.</li> </ul>	—	—
	Lights On Indicator	<ul style="list-style-type: none"> <li>• Comes on when the position, tail, and other external lights are on.</li> </ul>	<ul style="list-style-type: none"> <li>• <b>Light Switches</b> P. 224</li> </ul>	—
	Front Fog Light Indicator*	<ul style="list-style-type: none"> <li>• Comes on when the front fog lights are on.</li> </ul>	—	—
	Rear Fog Light Indicator*	<ul style="list-style-type: none"> <li>• Comes on when the rear fog light is on.</li> </ul>	<ul style="list-style-type: none"> <li>• <b>Front and Rear Fog Lights*</b> P. 227</li> </ul>	—

\* Not available on all models

Indicator	Name	On/Blinking	Explanation	Message*2
 <p>Indicator</p>	Immobilizer System Indicator	<ul style="list-style-type: none"> <li>Blinks if the immobilizer system cannot recognise the key information.</li> </ul>	<ul style="list-style-type: none"> <li><b>Blinks</b> - You cannot start the engine. Turn the ignition switch to LOCK *1, pull the key out*2, and then insert the key and turn it to ON *1 again.</li> <li><b>Repeatedly blinks</b> - The system may be malfunctioning. Have your vehicle checked by a dealer.</li> <li>Do not attempt to alter this system or add other devices to it. Electrical problems can occur.</li> </ul>	<div style="border: 1px solid black; padding: 2px; margin-bottom: 5px;">Models without keyless access system</div>    <div style="border: 1px solid black; padding: 2px; margin-top: 5px;">Models with keyless access system</div>   

\*1: Models with the keyless access system have an **ENGINE START/STOP** button instead of an ignition switch.

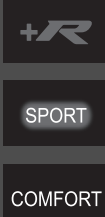
\*2: Right-hand drive models only: Apply and hold the brake and/or clutch pedal before turning the ignition on.

Indicator	Name	On/Blinking	Explanation	Message
 Indicator	Security System Alarm Indicator	<ul style="list-style-type: none"> <li>Blinks when the security system alarm has been set.</li> </ul>	<p>➤ <b>Security System Alarm</b> P. 208</p>	
	ECON Mode Indicator*	<ul style="list-style-type: none"> <li>Comes on when ECON mode is on.</li> </ul>	<p>➤ <b>ECON Mode*</b> P. 513</p>	
	Drive Mode Indicator*	<ul style="list-style-type: none"> <li>Comes on when each drive mode is selected by drive mode switch.</li> </ul>	<p>➤ <b>Drive Mode Switch</b> P. 526</p>	





\* Not available on all models

►► Indicators ►

Instrument Panel

Indicator	Name	On/Blinking	Explanation	Message
	Auto Idle Stop Indicator (Green)*	<ul style="list-style-type: none"> <li>Comes on when Auto Idle Stop is in operation. The engine automatically shuts off.</li> </ul>	<ul style="list-style-type: none"> <li> <b>Auto Idle Stop</b> P. 514, 520</li> </ul>	
		<p><b>Models with manual transmission</b></p> <ul style="list-style-type: none"> <li>Blinks when the ambient conditions may cause the windows to fog up.</li> <li>Blinks when the ambient conditions may become different from the climate control settings you have selected.</li> <li>Blinks when the  button is pressed.</li> </ul>	<ul style="list-style-type: none"> <li>Depress the clutch pedal. The engine automatically restarts.</li> <li> <b>Auto Idle Stop</b> P. 520</li> </ul>	
	Auto Idle Stop System Indicator (Amber)*	<ul style="list-style-type: none"> <li>Comes on for a few seconds when you turn the ignition switch to ON *1, then goes off.</li> </ul>	—	—
		<ul style="list-style-type: none"> <li>Comes on when the Auto Idle Stop system has been turned off by the Auto Idle Stop <b>OFF</b> button.</li> </ul>	<ul style="list-style-type: none"> <li> <b>Auto Idle Stop System ON/OFF</b> P. 515</li> </ul>	
		<ul style="list-style-type: none"> <li>Blinks if there is a problem with the Auto Idle Stop system.</li> </ul>	<ul style="list-style-type: none"> <li><b>Blinks</b> - Have your vehicle checked by a dealer.</li> </ul>	

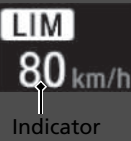



\*1: Models with the keyless access system have an **ENGINE START/STOP** button instead of an ignition switch.

Indicator	Name	On/Blinking	Explanation	Message
	Cruise Main Indicator*	<ul style="list-style-type: none"> <li>Comes on when you press the <b>MAIN</b> button. If a different indicator comes on, subsequently press the <b>LIM</b> button.</li> </ul>	<ul style="list-style-type: none"> <li>➤ <b>Cruise Control*</b> P. 529</li> </ul>	—
	Adjustable Speed Limiter Indicator*	<ul style="list-style-type: none"> <li>Comes on when you press the <b>MAIN</b> button. If a different indicator comes on, subsequently press the <b>LIM</b> button.</li> </ul>	<ul style="list-style-type: none"> <li>➤ <b>Adjustable Speed Limiter</b> P. 533</li> </ul>	—
	Cruise Control and Adjustable Speed Limiter Set Speed Indicator*	<ul style="list-style-type: none"> <li>Comes on when you have set a speed for cruise control.</li> <li>Comes on when you have set a speed for adjustable speed limiter.</li> </ul>	<ul style="list-style-type: none"> <li>➤ <b>Cruise Control*</b> P. 529</li> <li>➤ <b>Adjustable Speed Limiter</b> P. 534</li> </ul>	—
	Intelligent Speed Limiter Indicator*	<ul style="list-style-type: none"> <li>Comes on when you press the <b>MAIN</b> button. If a different indicator comes on, subsequently press the <b>LIM</b> button.</li> </ul>	<ul style="list-style-type: none"> <li>➤ <b>Intelligent Speed Limiter</b> P. 537</li> </ul>	—
	Adaptive Cruise Control (ACC) and Intelligent Speed Limiter Set Speed Indicator*	<ul style="list-style-type: none"> <li>Comes on when the intelligent speed limiter is set to the speed limit that the traffic sign recognition system detects.</li> <li>Comes on when you have set a speed for intelligent speed limiter.</li> </ul>	<ul style="list-style-type: none"> <li>➤ <b>Adaptive Cruise Control (ACC)</b> P. 593</li> <li>➤ <b>Adaptive Cruise Control (ACC) with Low Speed Follow</b> P. 576</li> <li>➤ <b>Intelligent Speed Limiter</b> P. 537</li> </ul>	—



\* Not available on all models

►► Indicators ►

Instrument Panel



Indicator	Name	On/Blinking	Explanation	Message
	Road Departure Mitigation Indicator*	<ul style="list-style-type: none"> <li>Comes on for a few seconds when you turn the ignition switch to ON *1, then goes off.</li> <li>Comes on if there is a problem with the road departure mitigation system.</li> </ul>	<ul style="list-style-type: none"> <li><b>Stays on constantly</b> - Have your vehicle checked by a dealer.</li> </ul>	
		<ul style="list-style-type: none"> <li>Comes on if the road departure mitigation system is deactivated temporarily after the battery has been disconnected, then re-connected.</li> </ul>	<ul style="list-style-type: none"> <li>Drive a short distance at more than 20 km/h (12 mph). The indicator should go off. If it does not, have your vehicle checked by a dealer.</li> </ul>	

\*1: Models with the keyless access system have an **ENGINE START/STOP** button instead of an ignition switch.





Indicator	Name	On/Blinking	Explanation	Message
	Road Departure Mitigation Indicator*	<ul style="list-style-type: none"> <li>Comes on when the road departure mitigation system shuts itself off.</li> </ul>	<ul style="list-style-type: none"> <li>Indicator may come on temporarily when passing through an enclosed space, such as a tunnel.</li> <li>The area around the radar sensor is blocked by dirt, mud, etc. Stop your vehicle in a safe place and wipe the debris off with a soft cloth. Indicator may take some time to go off after the radar sensor is cleaned.</li> <li>Have your vehicle checked by a dealer if the indicator does not go off even after you have cleaned the sensor cover.                             <ul style="list-style-type: none"> <li>➤ <b>Radar Sensor</b> P. 632</li> </ul> </li> </ul>	
			<ul style="list-style-type: none"> <li><b>Stays on</b> - The temperature inside the camera is too high. Use the climate control system* to cool down the camera. The system activates when the temperature inside the camera cools down.                             <ul style="list-style-type: none"> <li>➤ <b>Front Sensor Camera</b> P. 630</li> </ul> </li> </ul>	

\* Not available on all models

►► Indicators ►

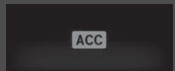
Indicator	Name	On/Blinking	Explanation	Message
	Road Departure Mitigation Indicator*	<ul style="list-style-type: none"> <li>Comes on when the road departure mitigation system shuts itself off.</li> </ul>	<ul style="list-style-type: none"> <li><b>Stays on</b> - The area around the camera is blocked by dirt, mud, etc. Stop your vehicle in a safe place and wipe the debris off with a soft cloth.                             <ul style="list-style-type: none"> <li>➤ <b>Front Sensor Camera</b> P. 630</li> </ul> </li> <li>Have your vehicle checked by a dealer if the indicator and message come back on after you cleaned the area around the camera.</li> </ul>	
		<ul style="list-style-type: none"> <li>Indicator may come on temporarily when the maximum permissible weight is exceeded.</li> </ul>	<ul style="list-style-type: none"> <li>Make sure the total load is within the maximum permissible weight.                             <ul style="list-style-type: none"> <li>➤ <b>Load Limit</b> P. 487</li> </ul> </li> <li><b>Stays on constantly</b> - Have your vehicle checked by a dealer.</li> </ul>	





Indicator	Name	On/Blinking	Explanation	Message
ACC	Adaptive Cruise Control (ACC) with Low Speed Follow* Indicator (Amber)*	<ul style="list-style-type: none"> <li>Comes on for a few seconds when you turn the ignition switch to ON <b>II</b>*<sup>1</sup>, then goes off.</li> <li>Comes on if there is a problem with ACC with Low Speed Follow*.</li> </ul>	<ul style="list-style-type: none"> <li><b>Comes on while driving</b> - Have your vehicle checked by a dealer.</li> </ul>	
		<ul style="list-style-type: none"> <li>Comes on if the ACC with Low Speed Follow* is deactivated temporarily after the battery has been disconnected, then re-connected.</li> </ul>	<ul style="list-style-type: none"> <li>Drive a short distance at more than 20 km/h (12 mph). The indicator should go off. If it does not, have your vehicle checked by a dealer.</li> </ul>	
		<ul style="list-style-type: none"> <li>Indicator may come on temporarily when the maximum permissible weight is exceeded.</li> <li>ACC with Low Speed Follow* has been automatically cancelled.</li> </ul>	<ul style="list-style-type: none"> <li>Make sure the total load is within the maximum permissible weight.                             <ul style="list-style-type: none"> <li>➤ <b>Load Limit</b> P. 487</li> </ul> </li> <li><b>Stays on constantly</b> - Have your vehicle checked by a dealer.</li> </ul>	
ACC	Adaptive Cruise Control (ACC) with Low Speed Follow* Indicator (Green)*	<ul style="list-style-type: none"> <li>Comes on when you press the <b>MAIN</b> button.</li> </ul>	<ul style="list-style-type: none"> <li>➤ <b>Adaptive Cruise Control (ACC) with Low Speed Follow</b> P. 576</li> <li>➤ <b>Adaptive Cruise Control (ACC)</b> P. 593</li> </ul>	

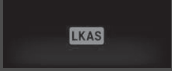

\*1: Models with the keyless access system have an **ENGINE START/STOP** button instead of an ignition switch.

\* Not available on all models

►► Indicators ►

Indicator	Name	On/Blinking	Explanation	Message
LKAS	Lane Keeping Assist System (LKAS) Indicator (Amber)*	<ul style="list-style-type: none"> <li>Comes on for a few seconds when you turn the ignition switch to ON *1, then goes off.</li> <li>Comes on if there is a problem with the LKAS.</li> </ul>	<ul style="list-style-type: none"> <li><b>Stays on constantly</b> - Have your vehicle checked by a dealer.</li> </ul>	
LKAS	Lane Keeping Assist System (LKAS) Indicator (Green)*	<ul style="list-style-type: none"> <li>Comes on when you press the <b>MAIN</b> button.</li> </ul>	 <b>Lane Keeping Assist System (LKAS)</b> P. 609	

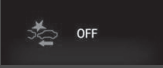



\* 1: Models with the keyless access system have an **ENGINE START/STOP** button instead of an ignition switch.



Indicator	Name	On/Blinking	Explanation	Message
	Collision Mitigation Braking System (CMBS) Indicator*	<ul style="list-style-type: none"> <li>• Comes on for a few seconds when you turn the ignition switch to ON <b>II</b>*<sup>1</sup>, then goes off.</li> <li>• Comes on when you deactivate the CMBS. A driver information interface message appears for five seconds.</li> <li>• Comes on if there is a problem with the CMBS.</li> </ul>	<ul style="list-style-type: none"> <li>• <b>Stays on constantly without the CMBS off</b> - Have your vehicle checked by a dealer.                             <ul style="list-style-type: none"> <li>➤ <b>Collision Mitigation Braking System (CMBS)</b> P. 565</li> </ul> </li> </ul>	
		<ul style="list-style-type: none"> <li>• Comes on if the CMBS is deactivated temporarily after the battery has been disconnected, then re-connected.</li> </ul>	<ul style="list-style-type: none"> <li>• Drive a short distance at more than 20 km/h (12 mph). The indicator should go off. If it does not, have your vehicle checked by a dealer.</li> </ul>	

\*1: Models with the keyless access system have an **ENGINE START/STOP** button instead of an ignition switch.

\* Not available on all models







►► Indicators ►

Indicator	Name	On/Blinking	Explanation	Message
	Collision Mitigation Braking System (CMBS) Indicator*	<ul style="list-style-type: none"> <li>Comes on when the CMBS shuts itself off.</li> </ul>	<ul style="list-style-type: none"> <li><b>Stays on</b> - The area around the camera is blocked by dirt, mud, etc. Stop your vehicle in a safe place, and wipe it off with a soft cloth.   <b>Front Sensor Camera</b> P. 630</li> <li>Have your vehicle checked by a dealer if the indicator does not go off even after you cleaned the camera.</li> </ul>	
			<ul style="list-style-type: none"> <li><b>Stays on</b> - The temperature inside the camera is too high. Use the climate control system* to cool down the camera. The system activates when the temperature inside the camera cools down.   <b>Front Sensor Camera</b> P. 630</li> </ul>	

Indicator	Name	On/Blinking	Explanation	Message
	Collision Mitigation Braking System (CMBS) Indicator*	<ul style="list-style-type: none"> <li>• Comes on when the CMBS shuts itself off.</li> </ul>	<ul style="list-style-type: none"> <li>• Indicator may come on temporarily when passing through an enclosed space, such as a tunnel.</li> <li>• The area around the radar sensor is blocked by dirt, mud, etc. Stop your vehicle in a safe place and wipe the debris off with a soft cloth. Indicator may take some time to go off after the radar sensor is cleaned.</li> <li>• Have your vehicle checked by a dealer if the indicator does not go off even after you have cleaned the sensor cover.                             <ul style="list-style-type: none"> <li>➤ <b>Radar Sensor</b> P. 632</li> </ul> </li> </ul>	
		<ul style="list-style-type: none"> <li>• Indicator may come on temporarily when the maximum permissible weight is exceeded.</li> </ul>	<ul style="list-style-type: none"> <li>• Make sure the total load is within the maximum permissible weight.                             <ul style="list-style-type: none"> <li>➤ <b>Load Limit</b> P. 487</li> </ul> </li> <li>• <b>Stays on constantly</b> - Have your vehicle checked by a dealer.</li> </ul>	









\* Not available on all models

►► Indicators ►

Indicator	Name	On/Blinking	Explanation	Message
	Blind spot information System Indicator*	<ul style="list-style-type: none"> <li>Comes on for a few seconds when you set the power mode to ON, then goes off.</li> <li>Stays on while the blind spot information system is turned off.</li> </ul>	<ul style="list-style-type: none"> <li>  <b>Blind spot information System*</b> P. 556                     </li> </ul>	
		<ul style="list-style-type: none"> <li>Comes on when mud, snow, or ice accumulates in the vicinity of sensor.</li> </ul>	<ul style="list-style-type: none"> <li> <b>Comes on while driving</b> - Remove the obstacle in the vicinity of the sensor.                             <ul style="list-style-type: none"> <li>  <b>Blind spot information System*</b> P. 556                                 </li> </ul> </li> </ul>	
		<ul style="list-style-type: none"> <li>Comes on if there is a problem with the system.</li> </ul>	<ul style="list-style-type: none"> <li> <b>Comes on while driving</b> - Have your vehicle checked by a dealer.                             </li> </ul>	

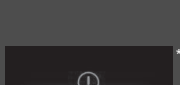



## Driver Information Interface Warning and Information Messages

The following messages appear only on the driver information interface. Press the  (display/information) button to see the message again with the system message indicator on.



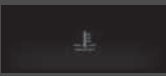

Message	Condition	Explanation
	<ul style="list-style-type: none"> <li>Appears once if the outside temperature is below 3°C while the ignition switch is in ON *1.</li> </ul>	<ul style="list-style-type: none"> <li>There is a possibility that the road surface is icy and slippery.</li> </ul>
	<ul style="list-style-type: none"> <li>Appears when the vehicle speed reaches the set speed. You can set two different speeds for the alarm.</li> </ul>	<ul style="list-style-type: none"> <li> <b>Speed Alarm</b> P. 166</li> </ul>
	<ul style="list-style-type: none"> <li>Appears when the starter system has a problem.</li> </ul>	<ul style="list-style-type: none"> <li>As a temporary measure, hold the ignition switch to START *1 for up to 15 seconds while pressing the brake pedal and clutch pedal (manual transmission only), manually start the engine. Have your vehicle checked by a dealer.</li> </ul>
<div style="border: 1px solid black; padding: 2px; width: fit-content;">Models with rear fog light</div> 	<ul style="list-style-type: none"> <li>Appears when the engine is running, there is a system problem in the engine oil level sensor.</li> </ul>	<ul style="list-style-type: none"> <li>Have your vehicle checked by a dealer.</li> </ul>
<div style="border: 1px solid black; padding: 2px; width: fit-content;">Models with rear fog light</div> 	<ul style="list-style-type: none"> <li>Appears when the engine oil level is low while the engine is running.</li> </ul>	<ul style="list-style-type: none"> <li><b>Appears while driving</b> - Immediately stop in a safe place.                             <ul style="list-style-type: none"> <li> <b>If the Low Oil Level Symbol Appears</b> P. 789</li> </ul> </li> </ul>

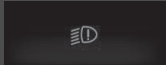
\*1: Models with the keyless access system have an **ENGINE START/STOP** button instead of an ignition switch.



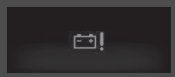

\* Not available on all models



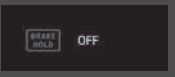

Message	Condition	Explanation
	<ul style="list-style-type: none"> <li>Appears when the engine coolant temperature gets abnormally high.</li> </ul>	<p>➤ <b>Overheating</b> P. 779</p>
<p>Except 2.0 L engine models</p>  <p>2.0 L engine models</p> 	<ul style="list-style-type: none"> <li>Appears when any of the rear seat belts are latched or unlatched, or either rear door is opened and closed.</li> </ul>	<p>➤ <b>Seat Belt Reminder</b> P. 49</p>
	<ul style="list-style-type: none"> <li>Appears if any door or the hatch is not completely closed.</li> <li>Appears if any door or the hatch is opened while driving. The beeper sounds.</li> </ul>	<ul style="list-style-type: none"> <li>Disappears when all doors and the hatch are closed.</li> </ul>
	<ul style="list-style-type: none"> <li>Appears if there is a problem with the automatic lighting control system.</li> <li>Appears when there is a problem with the headlights.</li> </ul>	<ul style="list-style-type: none"> <li><b>Appears while driving</b> - Manually turn the lights on, and have your vehicle checked by a dealer.</li> <li><b>Appears while driving</b> - The headlights may not be on. When conditions allow you to drive safely, have your vehicle checked by a dealer as soon as possible.</li> </ul>



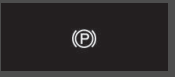

Message	Condition	Explanation
<p><b>1.0 L engine models</b></p> 	<ul style="list-style-type: none"> <li>Appears if there is a problem with the service reminder system*/oil monitor system*.</li> </ul>	<ul style="list-style-type: none"> <li>Have your vehicle checked by a dealer.</li> </ul>
	<ul style="list-style-type: none"> <li>Appears if there is a problem with the parking sensor system.</li> </ul>	<ul style="list-style-type: none"> <li>Check if the area around the sensor(s) is covered with mud, ice, snow, etc. If the indicator(s) stays on even after you clean the area, have the system checked by a dealer.</li> </ul>
	<ul style="list-style-type: none"> <li>Appears when there is a problem with the battery charging system.</li> </ul>	<ul style="list-style-type: none"> <li>Have your vehicle checked by a dealer.</li> </ul>
<p><b>Models without colour audio system</b></p>  <p><b>Models with colour audio system</b></p> 	<p><b>Continuously variable transmission models</b></p> <ul style="list-style-type: none"> <li>Appears while you are customizing the settings and the shift lever is moved out of <b>[P]</b>.</li> </ul> <p><b>Manual transmission models</b></p> <ul style="list-style-type: none"> <li>Appears while you are customizing the settings and the parking brake is released.</li> </ul>	<p>➤ <b>Customized Features</b>* P. 171</p>

\* Not available on all models



Message	Condition	Explanation
	<ul style="list-style-type: none"> <li>Appears when the automatic brake hold system is turned off.</li> </ul>	<ul style="list-style-type: none"> <li>➤ <b>Automatic Brake Hold</b> P. 636</li> </ul>
	<ul style="list-style-type: none"> <li>Appears when the automatic brake hold button is pressed without wearing the driver's seat belt.</li> </ul>	<ul style="list-style-type: none"> <li>Fasten the driver's seat belt.</li> <li>➤ <b>Automatic Brake Hold</b> P. 636</li> </ul>
Continuously variable transmission models  Manual transmission models 	<ul style="list-style-type: none"> <li>Appears when the automatic brake hold button is pressed without depressing the brake pedal while the automatic brake hold is in operation.</li> </ul>	<ul style="list-style-type: none"> <li>Press the automatic brake hold button with the brake pedal depressed.</li> <li>➤ <b>Automatic Brake Hold</b> P. 636</li> </ul>
	<ul style="list-style-type: none"> <li>Appears when the parking brake is applied automatically while it is in operation.</li> </ul>	<ul style="list-style-type: none"> <li>➤ <b>Automatic Brake Hold</b> P. 636</li> <li>➤ <b>Parking Brake</b> P. 633</li> </ul>

Message	Condition	Explanation
<p>Continuously variable transmission models</p>  <p>(Amber)</p> <p>Manual transmission models</p> 	<ul style="list-style-type: none"> <li>• Appears if the automatic brake hold is automatically cancelled while it is in operation.</li> </ul>	<ul style="list-style-type: none"> <li>• Immediately depress the brake pedal.</li> </ul>
<p>Continuously variable transmission models</p>  <p>Manual transmission models</p> 	<ul style="list-style-type: none"> <li>• Appears when the electric parking brake switch is pressed without depressing the brake pedal while the electric parking brake is in operation.</li> </ul>	<ul style="list-style-type: none"> <li>• Press the electric parking brake switch with the brake pedal depressed.                             <ul style="list-style-type: none"> <li>► <b>Parking Brake</b> P. 633</li> </ul> </li> </ul>

Models with service reminder system

Message	Condition	Explanation
	<ul style="list-style-type: none"> <li>Appears when any of the service items is required in less than 30 days.</li> </ul>	<ul style="list-style-type: none"> <li>The remaining days will be counted down per day.                      ➤ <b>Service Reminder System</b>* P. 665</li> </ul>
	<ul style="list-style-type: none"> <li>Appears when any of the service items is required in less than 10 days.</li> </ul>	<ul style="list-style-type: none"> <li>Have the indicated service performed as soon as possible.                      ➤ <b>Service Reminder System</b>* P. 665</li> </ul>
	<ul style="list-style-type: none"> <li>Appears when the indicated maintenance service is still not done after the remaining time reaches 0.</li> </ul>	<ul style="list-style-type: none"> <li>Your vehicle has passed the service required point. Immediately have the service performed and make sure to reset the service reminder.                      ➤ <b>Service Reminder System</b>* P. 665</li> </ul>

**Models with oil monitor system**

Message	Condition	Explanation
	<ul style="list-style-type: none"> <li>Appears when the maintenance service item which distance to the next maintenance period is less than 3,000 km (1,870 miles).</li> </ul>	<ul style="list-style-type: none"> <li>The remaining days will be counted down per 10 kilometres/miles.  <b>➤ Oil Monitor System</b> * P. 670</li> </ul>
	<ul style="list-style-type: none"> <li>Appears when the maintenance service item which distance to the next maintenance period is less than 1,000 km (630 miles).</li> </ul>	<ul style="list-style-type: none"> <li>Have the indicated service performed as soon as possible.  <b>➤ Oil Monitor System</b> * P. 670</li> </ul>
	<ul style="list-style-type: none"> <li>Appears when the indicated maintenance service is still not done after the remaining distance reaches 0.</li> </ul>	<ul style="list-style-type: none"> <li>Your vehicle has passed the service required point. Immediately have the service performed and make sure to reset the oil monitor.  <b>➤ Oil Monitor System</b> * P. 670</li> </ul>

**Models with adaptive damper system/2.0 L engine with rear fog light**



Message	Condition	Explanation
	<ul style="list-style-type: none"> <li>Appears if there is a problem with the adaptive damper system.</li> </ul>	<ul style="list-style-type: none"> <li>Have your vehicle checked by a dealer. Your vehicle will have normal damping ability without the adaptive damper feature.</li> </ul>

\* Not available on all models

**Models with headlight washer**

Message	Condition	Explanation
	<ul style="list-style-type: none"> <li>Appears when washer fluid is low.</li> </ul>	<ul style="list-style-type: none"> <li>Refill washer fluid. ➤ <b>Refilling Window Washer Fluid</b> P. 701</li> </ul>

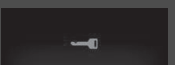

**Models without keyless access system**



Message	Condition	Explanation
	<ul style="list-style-type: none"> <li>Appears when you open the driver's door while the ignition key is in ACCESSORY [I].</li> </ul>	<ul style="list-style-type: none"> <li>Turn the ignition switch to LOCK [0], then remove the key.</li> </ul>
	<ul style="list-style-type: none"> <li>Appears when you open the driver's door while the ignition key is in LOCK [0].</li> </ul>	<ul style="list-style-type: none"> <li>Remove the key from the ignition switch.</li> </ul>
	<ul style="list-style-type: none"> <li>Appears when the ignition key is turned to ACCESSORY [I] from ON [II]. (The driver's door is closed.)</li> </ul>	—

**Models without keyless access system with manual transmission**

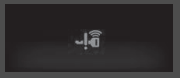
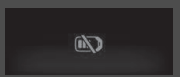

Message	Condition	Explanation
	<ul style="list-style-type: none"> <li>Appears when the ignition switch is turned to START [III] without depressing the clutch pedal.</li> </ul>	<ul style="list-style-type: none"> <li>Turn the ignition switch with depressing the clutch pedal.</li> </ul>

Models with keyless access system



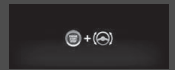

Message	Condition	Explanation
	<ul style="list-style-type: none"> <li>Appears as soon as a problem is detected in the keyless access system or keyless starting system.</li> </ul>	<ul style="list-style-type: none"> <li><b>Appears constantly</b> - Have your vehicle checked by a dealer.</li> </ul>
	<ul style="list-style-type: none"> <li>Appears when you close the door with the power mode in ON without the keyless remote inside the vehicle.</li> </ul>	<ul style="list-style-type: none"> <li>Disappears when you bring the keyless remote back inside the vehicle and close the door.                             <ul style="list-style-type: none"> <li>► <b>Keyless Remote Reminder</b> P. 221</li> </ul> </li> </ul>
	<ul style="list-style-type: none"> <li>Appears when the keyless remote battery becomes weak.</li> </ul>	<ul style="list-style-type: none"> <li>► <b>Replacing the Button Battery</b> P. 727</li> </ul>

Message	Condition	Explanation
<div style="border: 1px solid black; padding: 2px;">Continuously variable transmission models</div>  <div style="border: 1px solid black; padding: 2px;">Manual transmission models</div> 	<ul style="list-style-type: none"> <li>• Appears after you set the power mode to ACCESSORY or ON.</li> <li>• <b>Right-hand drive type</b></li> <li>• Appears after you unlock and open the driver's door.</li> </ul>	<p>➤ <b>Starting the Engine</b> P. 496</p>
	<ul style="list-style-type: none"> <li>• Appears when the power mode is in ACCESSORY.</li> <li>• Appears after the driver's door is opened when the power mode is in ACCESSORY.</li> </ul>	<p>—</p> <ul style="list-style-type: none"> <li>• Change the power mode to VEHICLE OFF.</li> <li>➤ <b>ENGINE START/STOP Button*</b> P. 219</li> </ul>







Message	Condition	Explanation
	<ul style="list-style-type: none"> <li>Appears if the keyless remote's battery is too weak to start the engine or the key is not within operating range to start the engine. The beeper sounds six times.</li> </ul>	<ul style="list-style-type: none"> <li>Bring the back of the keyless remote into contact with the <b>ENGINE START/STOP</b> button.                             <ul style="list-style-type: none"> <li>► <b>If the Keyless Remote Battery is Weak</b> P. 770</li> </ul> </li> </ul>
	<ul style="list-style-type: none"> <li>Appears when the steering wheel is locked.</li> </ul>	<ul style="list-style-type: none"> <li>Move the steering wheel left and right while pressing the <b>ENGINE START/STOP</b> button.</li> </ul>
<p>Continuously variable transmission models</p> 	<ul style="list-style-type: none"> <li>Appears if you press the <b>ENGINE START/STOP</b> button to turn the engine off without the shift lever in <b>P</b>.</li> </ul>	<ul style="list-style-type: none"> <li>Move the shift lever to <b>P</b>, then press the <b>ENGINE START/STOP</b> button twice.</li> </ul>
<p>Except 2.0 L engine models</p> 	<ul style="list-style-type: none"> <li>Appears if you press the <b>ENGINE START/STOP</b> button while the vehicle is moving.</li> </ul>	<ul style="list-style-type: none"> <li>► <b>Emergency Engine Stop</b> P. 771</li> </ul>

**Models with auto idle stop with continuously variable transmission**

Message	Condition	Explanation
 	<ul style="list-style-type: none"> <li>Appears when the engine does not restart automatically due to the following reasons:                             <ul style="list-style-type: none"> <li>- The bonnet is open.</li> <li>- There is a problem in the system that disables Auto Idle Stop.</li> </ul> </li> </ul>	<ul style="list-style-type: none"> <li>Follow the normal procedure to start the engine.                             <ul style="list-style-type: none"> <li>➤ <b>Starting the Engine</b> P. 493, 496</li> </ul> </li> </ul>
	<ul style="list-style-type: none"> <li>Appears when the engine stops without the shift lever in <b>[P]</b>, and does not restart automatically.</li> <li>Appears if you open the bonnet while Auto Idle Stop activates.</li> </ul>	<ul style="list-style-type: none"> <li>If you want to turn the ignition switch to LOCK <b>[0]</b><sup>*1</sup>, move the shift lever to <b>[P]</b>.</li> <li>If you want to start the engine, follow the normal procedure.                             <ul style="list-style-type: none"> <li>➤ <b>Starting the Engine</b> P. 493, 496</li> </ul> </li> </ul>
 (White)	<ul style="list-style-type: none"> <li>Appears when Auto Idle Stop does not activate because the pressure to the brake pedal is not enough.</li> </ul>	<ul style="list-style-type: none"> <li>Depress the brake pedal firmly.                             <ul style="list-style-type: none"> <li>➤ <b>Auto Idle Stop</b> P. 514</li> </ul> </li> </ul>



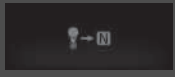

\*1: Models with the keyless access system have an **ENGINE START/STOP** button instead of an ignition switch.

Models with auto idle stop with manual transmission

Message	Condition	Explanation
 	<ul style="list-style-type: none"> <li>Appears when the engine does not restart automatically due to the following reasons:                             <ul style="list-style-type: none"> <li>The bonnet is open.</li> <li>There is a problem in the system that disables Auto Idle Stop.</li> </ul> </li> </ul>	<ul style="list-style-type: none"> <li>Follow the normal procedure to start the engine.                             <ul style="list-style-type: none"> <li>► <b>Starting the Engine</b> P. 493, 496</li> </ul> </li> </ul>
	<ul style="list-style-type: none"> <li>Appears when you move the shift lever from <b>N</b> to any other position without depressing the clutch pedal while Auto Idle Stop is in operation.</li> </ul>	<ul style="list-style-type: none"> <li>The engine will not start even when the battery charge becomes low. Shift to <b>N</b> to avoid the battery charge becomes low.                             <ul style="list-style-type: none"> <li>► <b>Auto Idle Stop</b> P. 520</li> </ul> </li> </ul>
	<ul style="list-style-type: none"> <li>Appears in white when you turn the ignition switch to START <b>III</b>*1 before fully depressing the clutch pedal.</li> </ul>	<ul style="list-style-type: none"> <li>Depress the clutch pedal.</li> </ul>
	<ul style="list-style-type: none"> <li>Appears in amber when the following conditions are kept while Auto Idle Stop is in operation:                             <ul style="list-style-type: none"> <li>You are not wearing a seat belt.</li> <li>The shift lever is in any position except <b>N</b>.</li> </ul> </li> </ul>	<ul style="list-style-type: none"> <li>Depress the clutch pedal. Wear the seat belt immediately, and continue to keep the shift lever in <b>N</b> next time Auto Idle Stop activates.</li> </ul>

\*1: Models with the keyless access system have an **ENGINE START/STOP** button instead of an ignition switch.



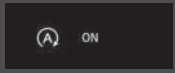
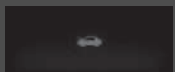

**Models with auto idle stop**





Message	Condition	Explanation
	<ul style="list-style-type: none"> <li>• Appears when Auto Idle Stop does not activate for some reason.</li> <li>• Appears when the engine restarts automatically.</li> <li>• Appears when the battery temperature is around 5°C or lower.</li> </ul>	<p>➤ <b>Auto Idle Stop Activates When:</b> P. 516, 522</p>
	<ul style="list-style-type: none"> <li>• Appears when Auto Idle Stop does not activate because the engine coolant temperature is too low or high.</li> </ul>	<p>➤ <b>Auto idle stop does not activate when:</b> P. 516, 522</p>
	<ul style="list-style-type: none"> <li>• Appears when Auto Idle Stop does not activate because the automatic heating system*/climate control system* is in use, and the difference between the set temperature and actual interior temperature becomes significant.</li> </ul>	<p>➤ <b>Auto Idle Stop Activates When:</b> P. 516, 522</p>
	<p><b>Models with continuously variable transmission</b></p> <ul style="list-style-type: none"> <li>• Appears when the system is under the following conditions while Auto Idle Stop activates:                             <ul style="list-style-type: none"> <li>- The automatic heating system*/climate control system* is in use, and the difference between the set temperature and actual interior temperature becomes significant.</li> <li>- The humidity in the interior is high.</li> </ul> </li> </ul>	<ul style="list-style-type: none"> <li>• The engine restarts automatically in a few seconds.</li> </ul>



Message	Condition	Explanation
	<ul style="list-style-type: none"> <li>• Appears when Auto Idle Stop does not activate because the battery charge level is low.</li> <li>• Appears when the battery is low performance.</li> </ul>	<p>➤ <b>Auto Idle Stop</b> P. 514, 520</p>
	<ul style="list-style-type: none"> <li>• Appears when the system is under the following conditions while Auto Idle Stop activates:                             <ul style="list-style-type: none"> <li>- The battery charge level is low.</li> </ul> </li> </ul>	<ul style="list-style-type: none"> <li>• The engine restarts automatically in a few seconds.</li> </ul>
	<ul style="list-style-type: none"> <li>• Appears when you turn the Auto Idle Stop system on.</li> </ul>	<p>➤ <b>Auto Idle Stop</b> P. 514, 520</p>
	<ul style="list-style-type: none"> <li>• Appears when the bonnet is opened.</li> </ul>	<ul style="list-style-type: none"> <li>• Close the bonnet.</li> </ul>

Models with CMBS



Instrument Panel



Message	Condition	Explanation
	<ul style="list-style-type: none"> <li>Appears if there is a problem with the auto high-beam.</li> </ul>	<ul style="list-style-type: none"> <li>Manually operate the headlight switch.</li> <li>If you are driving with the high-beam headlights when this happens, the headlights are changed to low beams.</li> </ul>
	<ul style="list-style-type: none"> <li>Appears if anything covers the radar sensor cover and prevents the sensor from detecting a vehicle in front.</li> <li>May appear when driving in bad weather (rain, snow, fog, etc.)</li> </ul>	<ul style="list-style-type: none"> <li>When the radar sensor gets dirty, stop your vehicle in a safe place, and wipe off dirt using a soft cloth. The message may take some time to go off.</li> <li>Have your vehicle checked by a dealer if the message does not disappear even after you clean the sensor cover.                             <ul style="list-style-type: none"> <li>➤ <b>Radar Sensor</b> P. 632</li> <li>➤ <b>Honda Sensing*</b> P. 562</li> </ul> </li> </ul>
	<ul style="list-style-type: none"> <li>Appears if the temperature inside the front sensor camera is too high and some driver assist systems cannot be activated.</li> </ul>	<ul style="list-style-type: none"> <li>Use the climate control system* to cool down the camera.</li> <li><b>Disappears</b> - The camera has been cooled down and the systems are activated normally.                             <ul style="list-style-type: none"> <li>➤ <b>Front Sensor Camera</b> P. 630</li> <li>➤ <b>Honda Sensing*</b> P. 562</li> </ul> </li> </ul>
	<ul style="list-style-type: none"> <li>Appears if the area around the front sensor camera is blocked by dirt, mud, etc. and be prevented from detecting a vehicle in front.</li> <li>May appear when driving in bad weather (rain, snow, fog, etc.)</li> </ul>	<ul style="list-style-type: none"> <li>When the front window gets dirty, stop your vehicle in a safe place, and wipe it off with a soft cloth.</li> <li>Have your vehicle checked by a dealer if the message does not disappear even after you cleaned the area around the camera.                             <ul style="list-style-type: none"> <li>➤ <b>Front Sensor Camera</b> P. 630</li> <li>➤ <b>Honda Sensing*</b> P. 562</li> </ul> </li> </ul>





Message	Condition	Explanation
	<ul style="list-style-type: none"> <li>Appears when ACC has been automatically cancelled.</li> </ul>	<ul style="list-style-type: none"> <li>You can resume the set speed after the condition that caused ACC to cancel improves. Press the <b>RES/+</b> button.                             <ul style="list-style-type: none"> <li>➤ <b>Adaptive Cruise Control (ACC) with Low Speed Follow</b> P. 576</li> <li>➤ <b>Adaptive Cruise Control (ACC)</b> P. 593</li> </ul> </li> </ul>
	<ul style="list-style-type: none"> <li>Appears when the system predicts the vehicle cutting in in front of you from the right and decrease your vehicle speed according to the cut-in vehicle.</li> </ul>	<ul style="list-style-type: none"> <li>The system automatically keeps a safe distance from the cut-in vehicle when the system predicts the cutting in.                             <ul style="list-style-type: none"> <li>➤ <b>How the system activates</b> P. 592</li> </ul> </li> </ul>
	<ul style="list-style-type: none"> <li>Appears when the system predicts the vehicle cutting in in front of you from the left and decrease your vehicle speed according to the cut-in vehicle.</li> </ul>	<ul style="list-style-type: none"> <li>The system automatically keeps a safe distance from the cut-in vehicle when the system predicts the cutting in.                             <ul style="list-style-type: none"> <li>➤ <b>How the system activates</b> P. 592</li> </ul> </li> </ul>
	<ul style="list-style-type: none"> <li>Flashes when the system senses a likely collision with a vehicle in front of you. The beeper sounds.</li> </ul>	<ul style="list-style-type: none"> <li>Take appropriate action to prevent a collision (apply the brakes, change lanes, etc.)                             <ul style="list-style-type: none"> <li>➤ <b>Adaptive Cruise Control (ACC) with Low Speed Follow</b> P. 576</li> <li>➤ <b>Collision Mitigation Braking System (CMBS)</b> P. 565</li> <li>➤ <b>Adaptive Cruise Control (ACC)</b> P. 593</li> </ul> </li> </ul>

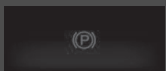

Message	Condition	Explanation
	<ul style="list-style-type: none"> <li>• Appears when the speed of the vehicle is too high for you to set ACC.</li> </ul>	<ul style="list-style-type: none"> <li>• Reduce the speed, then set ACC.                             <ul style="list-style-type: none"> <li>➤ <b>Adaptive Cruise Control (ACC) with Low Speed Follow</b> P. 576</li> <li>➤ <b>Adaptive Cruise Control (ACC)</b> P. 593</li> </ul> </li> </ul>
	<ul style="list-style-type: none"> <li>• Appears when ACC is cancelled due to excessive high vehicle speed.</li> </ul>	<ul style="list-style-type: none"> <li>• Reduce the speed, then reset ACC.                             <ul style="list-style-type: none"> <li>➤ <b>Adaptive Cruise Control (ACC) with Low Speed Follow</b> P. 576</li> <li>➤ <b>Adaptive Cruise Control (ACC)</b> P. 593</li> </ul> </li> </ul>
	<ul style="list-style-type: none"> <li>• Appears when the speed of the vehicle is too low for you to set ACC.</li> </ul>	<ul style="list-style-type: none"> <li>• Raise the speed, then set ACC.                             <ul style="list-style-type: none"> <li>➤ <b>Adaptive Cruise Control (ACC)</b> P. 593</li> </ul> </li> </ul>
	<ul style="list-style-type: none"> <li>• Appears when ACC is cancelled due to excessive low vehicle speed.</li> </ul>	<ul style="list-style-type: none"> <li>• Raise the speed, then reset ACC.                             <ul style="list-style-type: none"> <li>➤ <b>Adaptive Cruise Control (ACC)</b> P. 593</li> </ul> </li> </ul>
<p>Continuously variable transmission models</p>  <p>(Amber)</p>	<ul style="list-style-type: none"> <li>• Appears if ACC is cancelled while your vehicle is automatically stopped by ACC.</li> </ul>	<ul style="list-style-type: none"> <li>• Immediately depress the brake pedal.</li> </ul>



Message	Condition	Explanation
	<ul style="list-style-type: none"> <li>Appears when the distance between your vehicle and the vehicle ahead of you is too close while ACC is in operation.</li> </ul>	<ul style="list-style-type: none"> <li>ACC has been automatically cancelled.                             <ul style="list-style-type: none"> <li>➤ <b>Adaptive Cruise Control (ACC) with Low Speed Follow</b> P. 576</li> <li>➤ <b>Adaptive Cruise Control (ACC)</b> P. 593</li> </ul> </li> </ul>
	<ul style="list-style-type: none"> <li>Appears when pressing the <b>–/SET</b> button while the distance between your vehicle and the vehicle ahead of you is too close.</li> </ul>	<ul style="list-style-type: none"> <li>ACC cannot be set.                             <ul style="list-style-type: none"> <li>➤ <b>Adaptive Cruise Control (ACC) with Low Speed Follow</b> P. 576</li> <li>➤ <b>Adaptive Cruise Control (ACC)</b> P. 593</li> </ul> </li> </ul>
	<ul style="list-style-type: none"> <li>Appears when the vehicle is stopped on a very steep slope while ACC is in operation.</li> </ul>	<ul style="list-style-type: none"> <li>ACC has been automatically cancelled.                             <ul style="list-style-type: none"> <li>➤ <b>Adaptive Cruise Control (ACC) with Low Speed Follow</b> P. 576</li> </ul> </li> </ul>
	<ul style="list-style-type: none"> <li>Appears when pressing the <b>–/SET</b> button while the vehicle is stopped on a very steep slope.</li> </ul>	<ul style="list-style-type: none"> <li>ACC cannot be set.                             <ul style="list-style-type: none"> <li>➤ <b>Adaptive Cruise Control (ACC) with Low Speed Follow</b> P. 576</li> </ul> </li> </ul>
	<ul style="list-style-type: none"> <li>Appears when the driver's seat belt is unfastened while your vehicle is automatically stopped by ACC.</li> </ul>	<ul style="list-style-type: none"> <li>ACC has been automatically cancelled.                             <ul style="list-style-type: none"> <li>➤ <b>Adaptive Cruise Control (ACC) with Low Speed Follow</b> P. 576</li> </ul> </li> </ul>
	<ul style="list-style-type: none"> <li>Appears when pressing the <b>–/SET</b> button while the driver's seat belt is unfastened.</li> </ul>	<ul style="list-style-type: none"> <li>ACC cannot be set.                             <ul style="list-style-type: none"> <li>➤ <b>Adaptive Cruise Control (ACC) with Low Speed Follow</b> P. 576</li> </ul> </li> </ul>



Message	Condition	Explanation
Continuously variable transmission models	<ul style="list-style-type: none"> <li>Appears when the shift lever is moved into any position other than <b>D</b> or <b>S</b> while ACC is in operation.</li> </ul>	<ul style="list-style-type: none"> <li>ACC has been automatically cancelled.                             <ul style="list-style-type: none"> <li>➤ <b>Adaptive Cruise Control (ACC) with Low Speed Follow</b> P. 576</li> </ul> </li> </ul>
	<ul style="list-style-type: none"> <li>Appears when pressing the <b>-/SET</b> button while the shift lever is in any position other than <b>D</b> or <b>S</b>.</li> </ul>	<ul style="list-style-type: none"> <li>ACC cannot be set.                             <ul style="list-style-type: none"> <li>➤ <b>Adaptive Cruise Control (ACC) with Low Speed Follow</b> P. 576</li> </ul> </li> </ul>
	<ul style="list-style-type: none"> <li>Appears when the parking brake is applied automatically while ACC is in operation.</li> <li>Appears when pressing the <b>-/SET</b> button while the parking brake is applied.</li> </ul>	<ul style="list-style-type: none"> <li>ACC has been automatically cancelled.                             <ul style="list-style-type: none"> <li>➤ <b>Adaptive Cruise Control (ACC) with Low Speed Follow</b> P. 576</li> <li>➤ <b>Parking Brake</b> P. 633</li> </ul> </li> <li>ACC cannot be set.                             <ul style="list-style-type: none"> <li>➤ <b>Adaptive Cruise Control (ACC) with Low Speed Follow</b> P. 576</li> <li>➤ <b>Parking Brake</b> P. 633</li> </ul> </li> </ul>
	<ul style="list-style-type: none"> <li>Appears when the vehicle ahead of you resumes driving, after your vehicle has been stopped automatically by ACC.</li> </ul>	<ul style="list-style-type: none"> <li>Press the <b>RES/+</b> or <b>-/SET</b> button or depress the accelerator pedal to resume.                             <ul style="list-style-type: none"> <li>➤ <b>Adaptive Cruise Control (ACC) with Low Speed Follow</b> P. 576</li> </ul> </li> </ul>

Message	Condition	Explanation
<p>Continuously variable transmission models</p>  <p>Manual transmission models</p> 	<ul style="list-style-type: none"> <li>• Appears when pressing the <b>RES/+</b> or <b>-/SET</b> button while the vehicle is moving and the brake pedal is depressed.</li> </ul>	<ul style="list-style-type: none"> <li>• ACC cannot be set.                             <ul style="list-style-type: none"> <li>► <b>Adaptive Cruise Control (ACC) with Low Speed Follow</b> P. 576</li> <li>► <b>Adaptive Cruise Control (ACC)</b> P. 593</li> </ul> </li> </ul>
<p>Manual transmission models</p> 	<ul style="list-style-type: none"> <li>• Appears when pressing the <b>RES/+</b> or <b>-/SET</b> button while the vehicle is moving and the clutch pedal is depressed.</li> </ul>	<ul style="list-style-type: none"> <li>• ACC cannot be set.                             <ul style="list-style-type: none"> <li>► <b>Adaptive Cruise Control (ACC)</b> P. 593</li> </ul> </li> </ul>
<p>2.0 L engine models</p> 	<ul style="list-style-type: none"> <li>• Appears when pressing the <b>RES/+</b> or <b>-/SET</b> button while the VSA is completely disabled.                             <ul style="list-style-type: none"> <li>► <b>When the drive mode is in +R mode</b> P. 546</li> </ul> </li> </ul>	<ul style="list-style-type: none"> <li>• ACC cannot be set.                             <ul style="list-style-type: none"> <li>► <b>Adaptive Cruise Control (ACC)</b> P. 593</li> </ul> </li> </ul>
	<ul style="list-style-type: none"> <li>• Appears if the VSA or traction control function operates while ACC is in operation.</li> </ul>	<ul style="list-style-type: none"> <li>• ACC has been automatically cancelled.                             <ul style="list-style-type: none"> <li>► <b>Adaptive Cruise Control (ACC) with Low Speed Follow</b> P. 576</li> <li>► <b>Adaptive Cruise Control (ACC)</b> P. 593</li> </ul> </li> </ul>







Message	Condition	Explanation
 (Amber)	<b>Lane Keeping Assist System (LKAS)</b> <ul style="list-style-type: none"> <li>• Appears when the vehicle is driving out of a detected lane. The steering wheel vibrates rapidly.</li> </ul>	<ul style="list-style-type: none"> <li>• Keep the vehicle within the lane you are driving.                             <ul style="list-style-type: none"> <li>➤ <b>Lane Keeping Assist System (LKAS)</b> P. 609</li> </ul> </li> </ul>
	<b>Road Departure Mitigation System</b> <ul style="list-style-type: none"> <li>• Appears when the vehicle is driving out of a detected lane.                             <ul style="list-style-type: none"> <li><b>When you selected Warning Only</b> <ul style="list-style-type: none"> <li>- The steering wheel vibrates rapidly when the vehicle is drifting out of a detected lane.</li> </ul> </li> <li><b>When you selected Normal, Delayed or Early</b> <ul style="list-style-type: none"> <li>- The steering wheel vibrates rapidly when the vehicle is drifting out of a detected lane. The system also steers the vehicle to help you remain within your driving lane.</li> </ul> </li> </ul> </li> </ul>	<ul style="list-style-type: none"> <li>• Keep the vehicle within the lane you are driving.                             <ul style="list-style-type: none"> <li>➤ <b>Road Departure Mitigation System</b> P. 617</li> </ul> </li> <li>• You can change the setting for the road departure mitigation system. <b>Normal, Delayed, Warning Only, and Early</b> can be selected.                             <ul style="list-style-type: none"> <li>➤ <b>Customized Features</b> P. 171, 396</li> </ul> </li> </ul>
	<ul style="list-style-type: none"> <li>• Blinks when you fail to steer the vehicle. The beeper sounds simultaneously.</li> </ul>	<ul style="list-style-type: none"> <li>• Operate the steering wheel to resume the LKAS.</li> </ul>
	<ul style="list-style-type: none"> <li>• Appears when the LKAS is in operation, or the LKAS button is pressed, but there is a problem with a system related to the LKAS. The LKAS cancels automatically. The beeper sounds simultaneously.</li> </ul>	<ul style="list-style-type: none"> <li>• If any other system indicators come on, such as the VSA, ABS and brake system, take appropriate action.                             <ul style="list-style-type: none"> <li>➤ <b>Indicators</b> P. 108</li> </ul> </li> </ul>

Message	Condition	Explanation
 (White)	<p><b>Road Departure Mitigation System</b>                      When you selected <b>Early</b></p> <ul style="list-style-type: none"> <li>• Appears when the vehicle is likely to drive out of a detected lane. The Road Departure Mitigation system also steers the vehicle to help you remain within your driving lane.</li> </ul>	—

**2.0 L engine models**

Message	Condition	Explanation
	<ul style="list-style-type: none"> <li>• Appears if there is a problem with a system related to Rev Match System while the system is activated by customization.</li> </ul>	<ul style="list-style-type: none"> <li>• Have your vehicle checked by a dealer.</li> </ul>
	<ul style="list-style-type: none"> <li>• Appears if the drive mode cannot be changed due to certain situations, such as a system error or adverse driving conditions.</li> </ul>	<p>➤ <b>Drive Mode Switch</b> P. 526</p>
<p>Models with rear fog light</p> 	<ul style="list-style-type: none"> <li>• Appears when there is a problem with the pop-up hood system.</li> </ul>	<ul style="list-style-type: none"> <li>• Have your vehicle checked by a dealer.</li> </ul> <p>➤ <b>Pop-up Hood System*</b> P. 71</p>

\* Not available on all models

Message	Condition	Explanation
	<ul style="list-style-type: none"> <li>Appears when the vehicle is in <b>+R</b> mode and you press the Road Departure Mitigation button after you have deactivated VSA by pressing and holding the  (VSA OFF) button.</li> </ul>	<ul style="list-style-type: none"> <li>➤ <b>Drive Mode Switch</b> P. 526</li> <li>➤ <b>VSA On and Off</b> P. 545</li> </ul>
	<ul style="list-style-type: none"> <li>Appears when the vehicle is in <b>+R</b> mode and you press the Collision Mitigation Braking System (CMBS) button after you have deactivated VSA by pressing and holding the  button.</li> </ul>	<ul style="list-style-type: none"> <li>➤ <b>Drive Mode Switch</b> P. 526</li> <li>➤ <b>VSA On and Off</b> P. 545</li> </ul>
	<ul style="list-style-type: none"> <li>Appears when the vehicle is in <b>+R</b> mode and you deactivate VSA by pressing and holding the  button. Once you have deactivated VSA, this message will appear again if you put the vehicle into another drive mode.</li> </ul>	<ul style="list-style-type: none"> <li>To reactivate Honda Sensing, press the  button again to turn on VSA. After that, you can reactivate the following features:                             <ul style="list-style-type: none"> <li>➤ <b>Road Departure Mitigation System</b> P. 617</li> <li>➤ <b>Collision Mitigation Braking System (CMBS)</b> P. 565</li> </ul> </li> </ul>

# Gauges and Driver Information Interface

## Gauges

Gauges include the speedometer, fuel gauge, and related indicators. They are displayed when the ignition switch is in ON \*1.

### ■ Speedometer

Displays your driving speed in km/h or mph.

### ■ Tachometer

Shows the number of engine revolutions per minute.

### ■ Fuel Gauge



Displays the amount of fuel left in the fuel tank.

\*1: Models with the keyless access system have an **ENGINE START/STOP** button instead of an ignition switch.

\* Not available on all models

### » Gauges

#### Right-hand drive type

Press the  (display/information) button repeatedly until the  icon is shown on the driver information interface. Press **ENTER**, then press and hold it again. The speedometer reading and the displayed measurements will switch between km/h and mph.

### » Tachometer

You can turn on or off the tachometer display.

➔ **Customized Features**\* P. 171

### » Fuel Gauge

#### NOTICE

You should refuel when the reading approaches . Running out of fuel can cause the engine to misfire, damaging the catalytic converter.

The actual amount of remaining fuel may differ from the fuel gauge reading.

Continued

## ■ Temperature Gauge

Displays the temperature of the engine coolant.

## ☒ Temperature Gauge

### NOTICE

Driving with the temperature gauge pointer in the upper zone can cause serious engine damage. Pull safely to the side of the road and allow engine temperature to return to normal.

☒ **Overheating** P. 779

## ■ Shift Up Backlight\*/Shift Up Alarm\*



The shift up backlight blinks and the alarm sounds when the tachometer reading approaches the red zone.

## ☒ Shift Up Backlight\*/Shift Up Alarm\*

You can use the customized features to turn the shift up backlight feature and the shift up alarm feature on and off.

☒ **Customized Features** P. 396





## Driver Information Interface

The driver information interface shows the odometer, trip meter, outside temperature indicator, and other gauges. It also displays important messages such as warnings and other helpful information.

### Switching the Display

#### Main displays

Press the  (display/information) button, and then press  or  to change the display. Press **ENTER** to see detailed information.

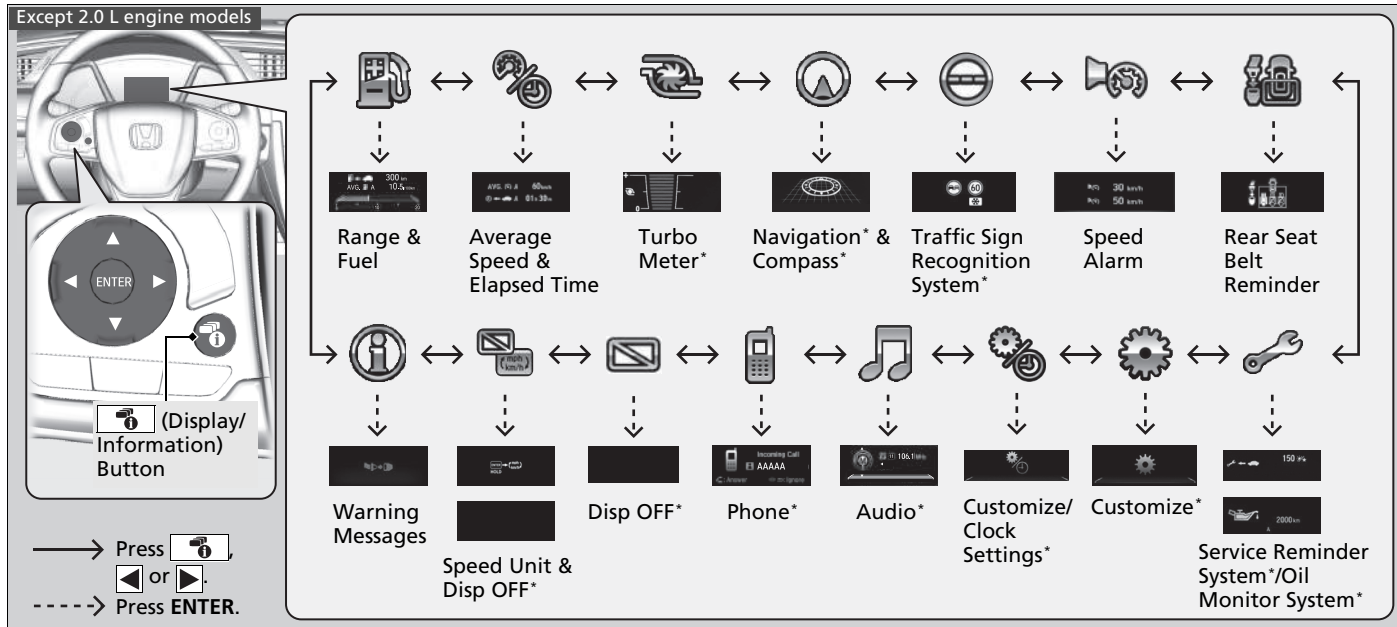

\* Not available on all models

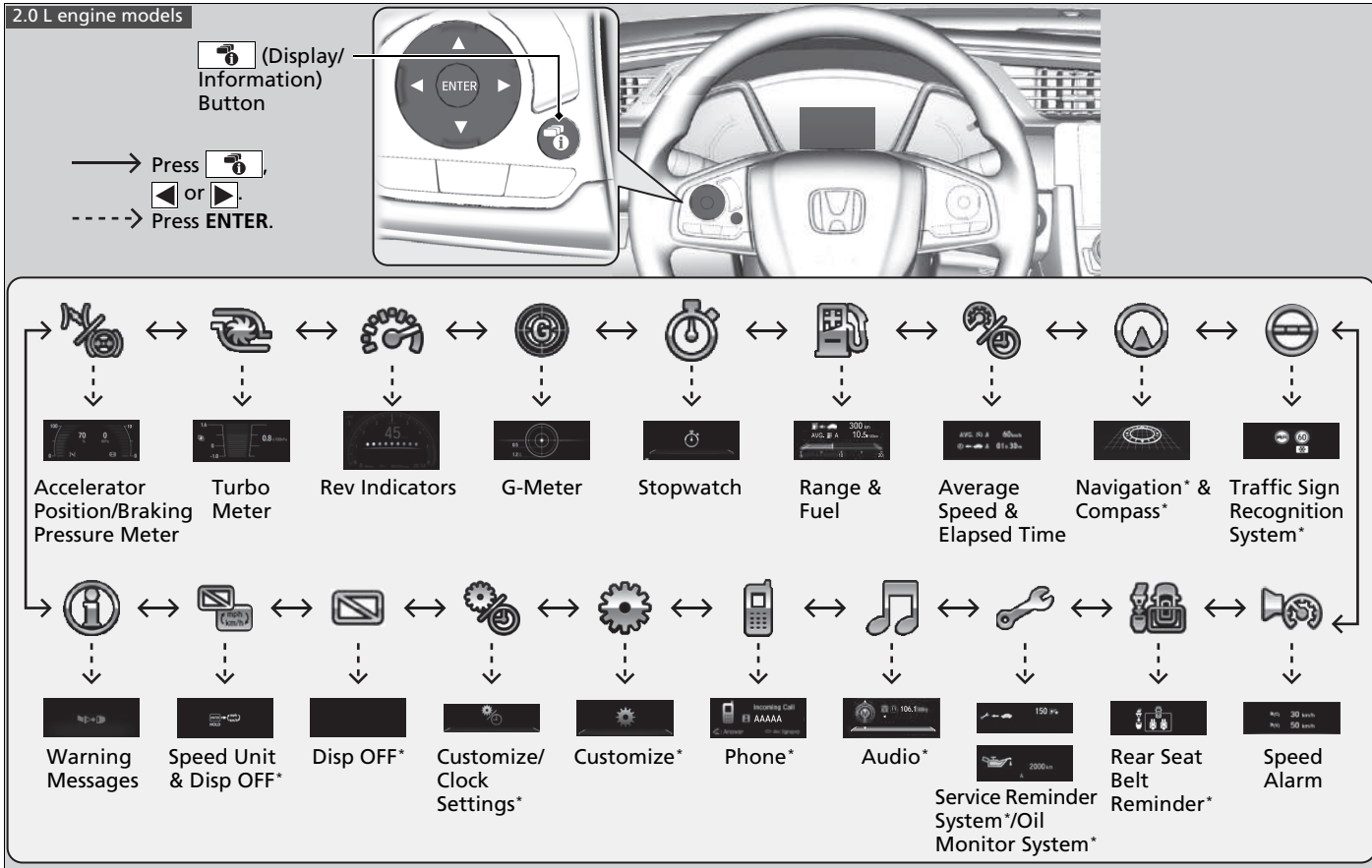

### ■ Sub Display

Press the  (TRIP) knob to change display.

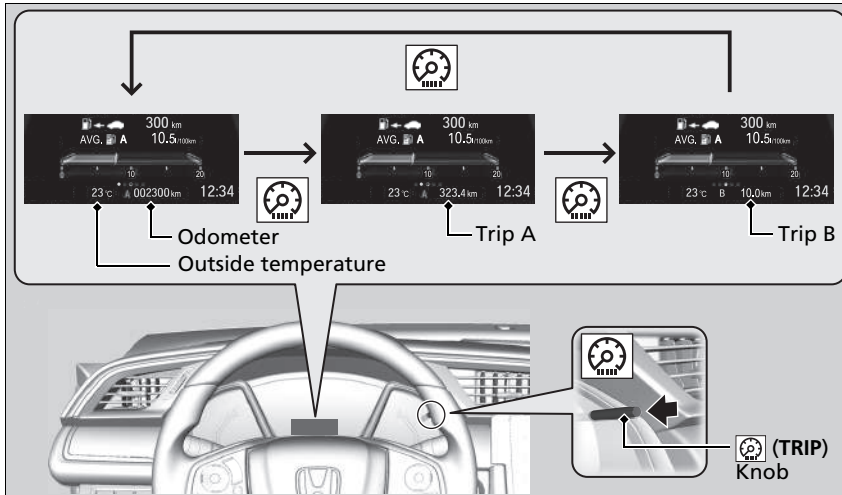

### ■ Odometer

Shows the total number of kilometres or miles that your vehicle has accumulated.

### ■ Trip Meter

Shows the total number of kilometres or miles driven since the last reset. Meters A and B can be used to measure two separate trips.

### ▶ Trip Meter

Switch between trip meter A and trip meter B by pressing the  knob.

### ■ Resetting a trip meter

To reset a trip meter, display it, then press and hold the  knob. The trip meter is reset to **0.0**.

### ■ Average Fuel Economy

Shows the estimated average fuel economy of each trip meter in l/100 km or mpg. The display is updated at set intervals. When a trip meter is reset, the average fuel economy is also reset.

### ■ Range

Shows the estimated distance you can travel on the remaining fuel. This estimated distance is based on the vehicle's current fuel economy.

### ■ Elapsed Time

Shows the time elapsed since Trip A or Trip B was reset.

### ■ Average Speed

Shows the average speed in km/h or mph since Trip A or Trip B was reset.

### ■ Instant Fuel Economy Gauge

Shows the instant fuel economy as a bar graph in l/100 km or mpg.

#### ⌘ Average Fuel Economy

You can change when to reset the average fuel economy.

➤ **Customized Features\*** P. 171, 396

#### ⌘ Elapsed Time

You can change when to reset the elapsed time.

➤ **Customized Features\*** P. 171, 396

#### ⌘ Average Speed

You can change when to reset the average speed.

➤ **Customized Features\*** P. 171, 396

### ■ Service Reminder System\*

Shows the service reminder system.

➤ **Service Reminder System\*** P. 665

### ■ Oil Monitor System\*

Show the oil monitor system.

➤ **Oil Monitor System\*** P. 670

### ■ Rear Seat Belt Reminder

Appears when any of the rear seat belts are latched or unlatched.

### ■ Outside Temperature

Shows the outside temperature in Celsius.

If the outside temperature has been below 3°C at the time you turn the ignition switch to ON **II**<sup>\*1</sup>, the outside temperature indicator blinks for 10 seconds.

#### ■ Adjusting the outside temperature display

Adjust the temperature reading up to ±3°C if the temperature reading seems incorrect.

### ■ Turbo Meter\*

When the turbo is producing boost, this meter indicates boost pressure is building.

\*1: Models with the keyless access system have an **ENGINE START/STOP** button instead of an ignition switch.

\* Not available on all models

#### »» Outside Temperature

The temperature sensor is in the front bumper. Road heat and exhaust from another vehicle can affect the temperature reading when your vehicle speed is less than 30 km/h (19 mph).

It may take several minutes for the display to be updated after the temperature reading has stabilized.

You can adjust the temperature reading.

➤ **Customized Features\*** P. 171, 396

*Continued*

## Speed Alarm

Sets the speed alarm on and changes the speed alarm setting.

Each time you press the  button, the speed alarm setting changes as follows:

Instrument Panel

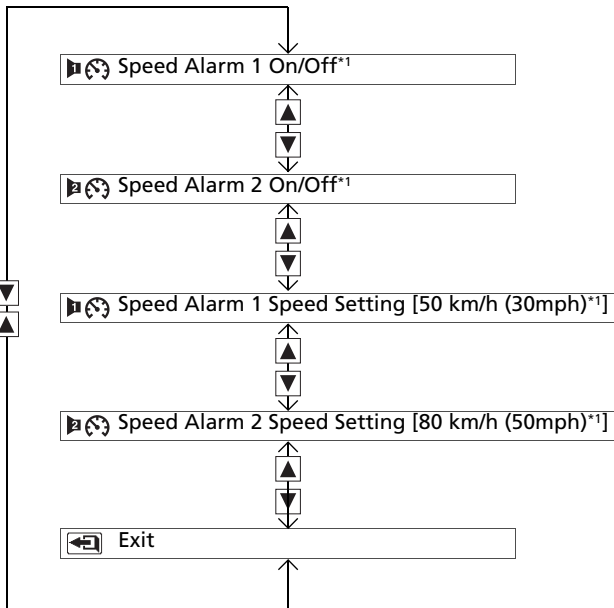

\*1: Default Setting

## ■ Navigation \*

### ■ Compass\*

Shows the compass screen.

### ■ Turn-by-Turn Directions

When driving guidance is provided by the navigation system\* or Android Auto, turn-by-turn directions to your destination appear.

➤ **Refer to the Navigation System Manual**

➤ **Android Auto** P. 376

## ■ Traffic Sign Recognition System \*

Shows the traffic sign recognition system.

➤ **Traffic Sign Recognition System** P. 623

## ■ Audio \*

Shows the current audio information.

➤ **Audio System Basic Operation** P. 290, 315

## ■ Phone \*

Shows the current phone information.

➤ **Hands-Free Telephone System** P. 430, 451

## ▣ Navigation \*

You can select whether to have the turn-by-turn display comes on or not during the route guidance.

➤ **Customized Features** P. 396

\* Not available on all models

### ■ G-Meter\*

Displays the strength (G) and direction of the load that is applied to the vehicle during driving.

### ■ Braking Pressure Meter\*

Displays the brake pressure in MPa when the brake is applied.

### ■ Accelerator Position Meter\*

Displays the accelerator position in degrees of %.

### ■ Rev Indicators\*

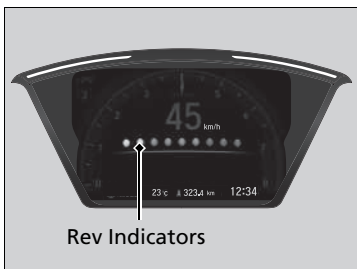

Light up from left to right according to engine speed.



## ■ Stopwatch \*

Measures the lap time, and displays the previously measured times, split time and the fastest lap time.

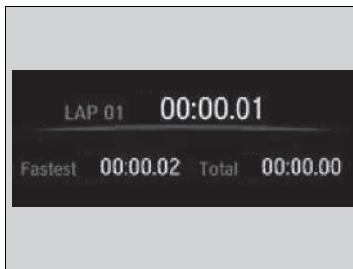
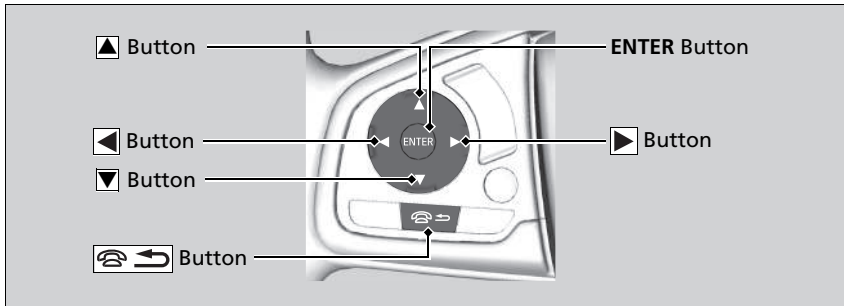

### ■ Measuring LAP Time

1. Press the **ENTER** button to display the lap time measurement screen.
2. Press the **ENTER** button to start measurement.
3. Press the **ENTER** button again to stop measurement.
  - ▶ To measure the time per lap, press the ▲/▼ button at the completion of each lap.
  - ▶ To return to the **Stopwatch** screen, press the ☎️ ↶ (Hang-up/back) button.

## ▶▶ Stopwatch \*

Be sure to use this measurement function only where and when it is safe to do so.





Lap time is displayed from 00:00.00 to 9:59:59.99.

\* Not available on all models

Continued



### ■ Checking and Clearing History

- To check history, press the  button (when lap time is not running) to change the display, then press the  button to scroll through lap times.
  - A maximum of 20 lap times can be stored at a time.
- To clear history, press and hold the  button when lap time is not running.
- To return to the lap time measurement screen, press the  button.
- To return to the **Stopwatch** screen, press the  (Hang-up/back) button.

## ■ Customized Features\*

Use the driver information interface to customize certain features.

### ■ How to customize

Select the / (Customize Settings) screen by pressing the button while the ignition switch is in ON **II**, and the vehicle is at a complete stop, and the shift lever is in **P** (continuously variable transmission), and the parking brake is set (manual transmission). Select / , then press the **ENTER** button.

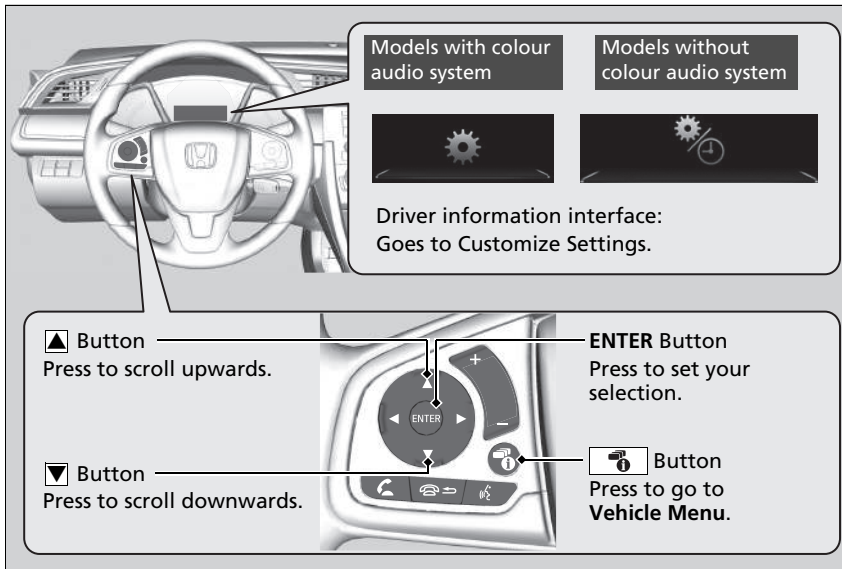

\* Not available on all models

Continued

## ▶ Customized Features\*

To customize other features, press the / button.

▶ **List of customizable options** P. 175

▶ **Example of customization settings** P. 181

When you customize settings:

**Models with continuously variable transmission**

Shift to **P**.

**Models with manual transmission**

Set the parking brake.

■ **Customization flow**

Press the  button.

Instrument Panel

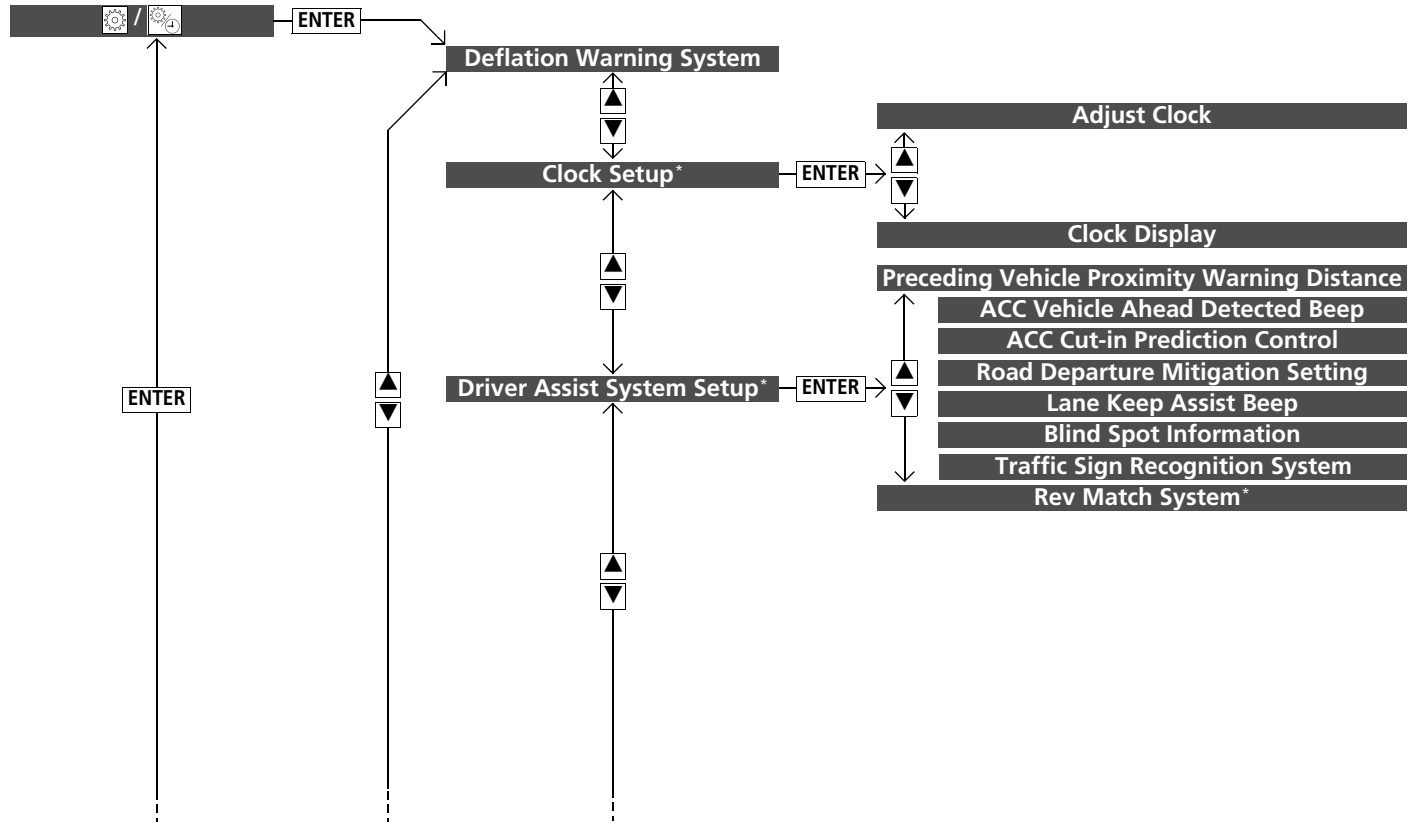

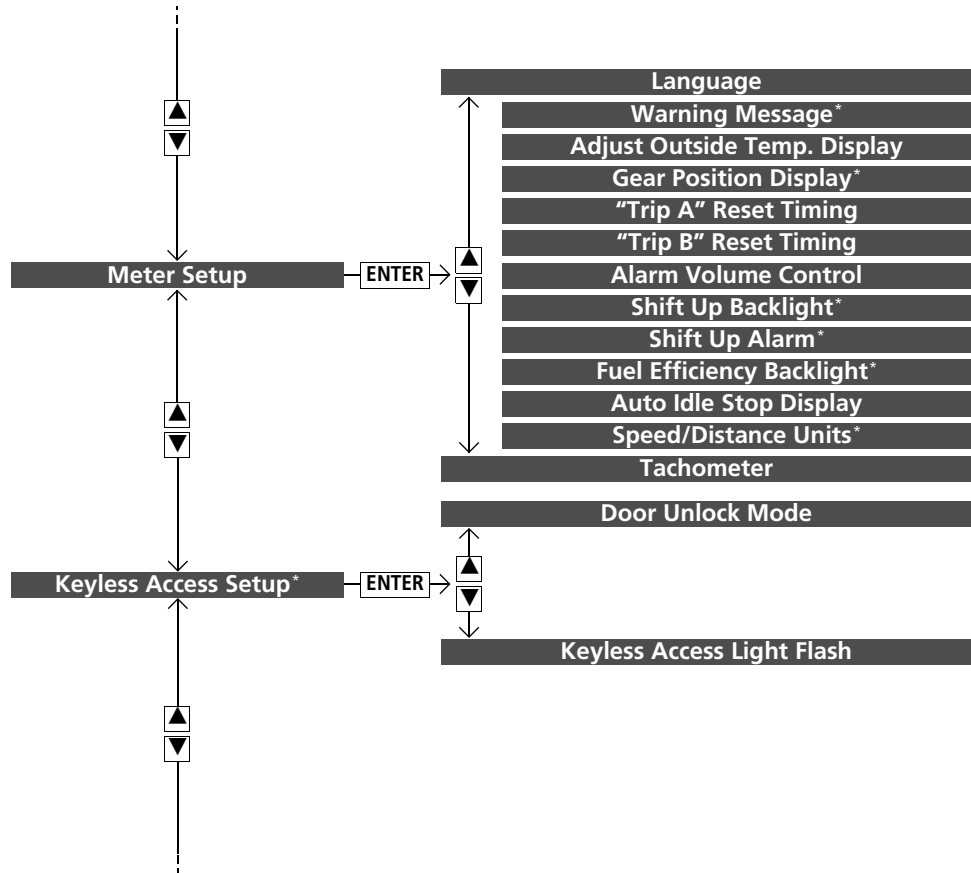

\* Not available on all models

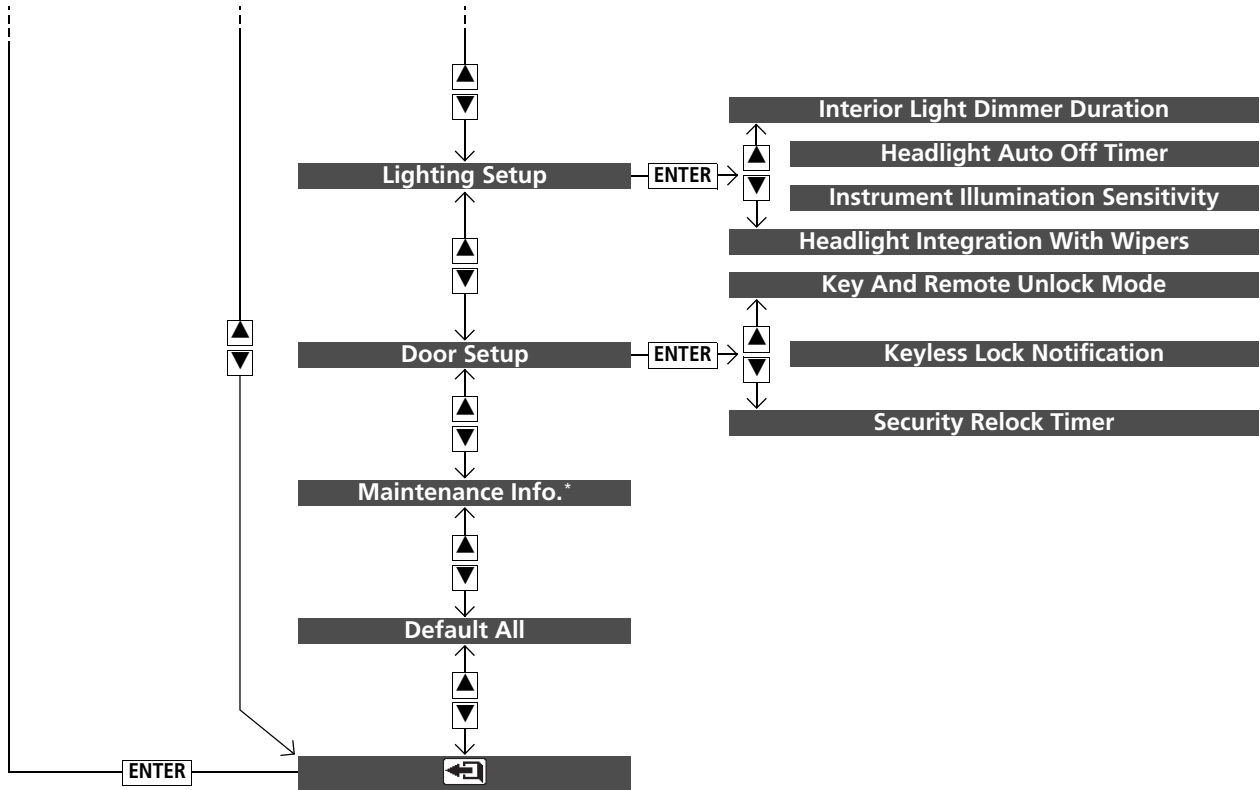

■ List of customizable options

Setup Group	Customizable Features	Description	Selectable Settings
<b>Deflation Warning System</b>	—	Initialises the deflation warning system.	<b>Initialise/Cancel</b>
<b>Clock Setup*</b>	<b>Adjust Clock</b>	Adjust the time.  <b>Adjusting the Clock</b> P. 186	—
	<b>Clock Display</b>	Sets time display 24 hour, 12 hour or off.	<b>24 h/12 h*<sup>1</sup>/OFF</b>

\*1:Default Setting

\* Not available on all models

Setup Group	Customizable Features	Description	Selectable Settings
<b>Driver Assist System Setup*</b>	<b>Preceding Vehicle Proximity Warning Distance</b>	Changes the distance at which CMBS alerts.	<b>Far/Normal*<sup>1</sup>/Near</b>
	<b>ACC Vehicle Ahead Detected Beep</b>	Causes the system to beep when the system detects a vehicle, or when the vehicle goes out of ACC range.	<b>ON/OFF*<sup>1</sup></b>
	<b>ACC Cut-in Prediction Control</b>	Turns the ACC cut-in prediction control feature on and off.	<b>ON*<sup>1</sup>/OFF</b>
	<b>Road Departure Mitigation Setting</b>	Changes the setting for the road departure mitigation system.	<b>Early/Normal/Delayed*<sup>1</sup>/Warning Only</b>
	<b>Lane Keep Assist Beep</b>	Causes the system to beep when the LKAS is suspended.	<b>ON/OFF*<sup>1</sup></b>
	<b>Blind Spot Information</b>	Changes the setting for the blind spot information.	<b>Audible And Visual Alert*<sup>1</sup>/Visual Alert Only/OFF</b>
	<b>Traffic Sign Recognition System</b>	Selects whether the traffic sign small icons come on.	<b>Small Icons ON*<sup>1</sup>/Small Icons OFF</b>
	<b>Rev Match System*</b>	Turns the Rev Match System feature on and off.	<b>ON*<sup>1</sup>/OFF</b>

\*1:Default Setting



Setup Group	Customizable Features	Description	Selectable Settings
<b>Meter Setup</b>	<b>Language</b>	Changes the displayed language.	<b>English<sup>*1</sup>/French/Spanish/ German/Italian/ Portuguese/Russian/ Finnish/Norwegian/ Swedish/Danish/Dutch/ Polish/Turkish</b>
	<b>Warning Message<sup>*</sup></b>	Turns the driver information interface warning message on and off.	<b>ON/OFF<sup>*1</sup></b>
	<b>Adjust Outside Temp. Display</b>	Adjusts the temperature reading by a few degrees.	<b>-3°C ~ ±0°C<sup>*1</sup> ~ +3°C</b>
	<b>Gear Position Display<sup>*</sup></b>	Turns the gear position display feature on and off.	<b>ON<sup>*1</sup>/OFF</b>
	<b>“Trip A” Reset Timing</b>	Changes the setting of how to reset trip meter A, average fuel economy A, average speed A, and elapsed time A.	<b>When Refueled/When Ignition Is Turned Off/ Manual Reset<sup>*1</sup></b>
	<b>“Trip B” Reset Timing</b>	Changes the setting of how to reset trip meter B, average fuel economy B, average speed B, and elapsed time B.	<b>When Refueled/When Ignition Is Turned Off/ Manual Reset<sup>*1</sup></b>

\*1:Default Setting

\* Not available on all models

Setup Group	Customizable Features	Description	Selectable Settings
<b>Meter Setup</b>	<b>Alarm Volume Control</b>	Changes the alarm volume, such as buzzers, warnings, turn signal sound, and so on.	<b>Max/Mid<sup>*1</sup>/Min</b>
	<b>Shift Up Backlight<sup>*</sup></b>	Changes whether shift up backlight blinks when the tachometer reading approaches the red zone. <input checked="" type="checkbox"/> <b>Shift Up Backlight<sup>*</sup>/Shift Up Alarm<sup>*</sup></b> P. 160	<b>ON<sup>*1</sup>/OFF</b>
	<b>Shift Up Alarm<sup>*</sup></b>	Changes whether alarm sounds when the tachometer reading approaches the red zone.	<b>ON<sup>*1</sup>/OFF</b>
	<b>Fuel Efficiency Backlight<sup>*</sup></b>	Turns the ambient meter feature on and off.	<b>ON<sup>*1</sup>/OFF</b>
	<b>Auto Idle Stop Display</b>	Selects whether the Auto Idle Stop display comes on or not.	<b>ON<sup>*1</sup>/OFF</b>
	<b>Speed/Distance Units<sup>*</sup></b>	Changes the displayed measurement on the driver information interface.	<b>mph·miles<sup>*1</sup>/km/h·km</b>
	<b>Tachometer</b>	Selects whether the tachometer is displayed on the driver information interface.	<b>ON<sup>*1</sup>/OFF</b>
<b>Keyless Access Setup<sup>*</sup></b>	<b>Door Unlock Mode</b>	Changes which doors unlock when you grab the driver's door handle.	<b>Driver Door Only<sup>*1</sup>/All Doors</b>
	<b>Keyless Access Light Flash</b>	Causes some exterior lights to flash when you unlock/lock the doors.	<b>ON<sup>*1</sup>/OFF</b>

\*1:Default Setting

Setup Group	Customizable Features	Description	Selectable Settings
<b>Lighting Setup</b>	<b>Interior Light Dimmer Duration</b>	Changes the length of time the interior lights stay on after you close the doors.	<b>60sec/30sec<sup>*1</sup>/15sec</b>
	<b>Headlight Auto Off Timer</b>	Changes the length of time the exterior lights stay on after you close the driver's door.	<b>60sec/30sec/15sec<sup>*1</sup>/0sec</b>
	<b>Instrument Illumination Sensitivity</b>	Changes the sensitivity of the brightness of the instrument panel when the headlight switch is in the <b>AUTO</b> position.	<b>Max/High/Mid<sup>*1</sup>/Low/Min</b>
	<b>Headlight Integration With Wipers</b>	Changes the settings for the wiper operation when the headlights automatically come on while the headlight switch is in the <b>AUTO</b> position.	<b>ON<sup>*1</sup>/OFF</b>

\*1:Default Setting



Setup Group	Customizable Features	Description	Selectable Settings
<b>Door Setup</b>	<b>Key And Remote Unlock Mode</b>	Sets up either the driver's door or all doors to unlock on the first operation of the ignition key.	<b>Driver Door Only<sup>*1</sup>/All Doors</b>
	<b>Keyless Lock Notification</b>	LOCK/UNLOCK- The exterior lights flash.	<b>ON<sup>*1</sup>/OFF</b>
	<b>Security Relock Timer</b>	Changes the time it takes for the doors to relock and the security system to set after you unlock the vehicle without opening any door.	<b>90sec/60sec/30sec<sup>*1</sup></b>
<b>Maintenance Info.*</b>	—	Resets the service reminder display*/oil monitor display* when you have performed the maintenance service.	<div style="background-color: #333; color: white; padding: 2px;">Models with service reminder system</div> <b>Cancel/All Due Items</b> <div style="background-color: #333; color: white; padding: 2px;">Models with oil monitor system</div> <b>Cancel/Reset</b>
<b>Default All</b>	—	Cancels customized changes you have made or restores them to their default setting.	<b>OK/Cancel</b>

\*1:Default Setting

### ■ Example of customization settings

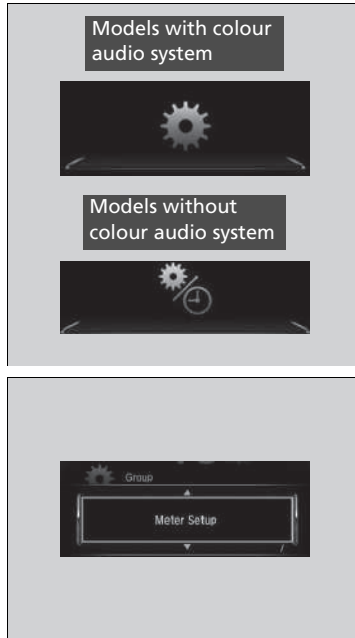
The steps for changing the “**Trip A**” **Reset Timing** setting to **When Refueled** are shown below. The default setting for “**Trip A**” **Reset Timing** is **Manual Reset**.





1. Press the  button to select  / , then press the **ENTER** button.

2. Press the  button until **Meter Setup** appears on the display.



3. Press the **ENTER** button.

▶ **Language** appears first in the display.



4. Press the  button until **"Trip A" Reset Timing** appears on the display, then press the **ENTER** button.
  - The display switches to the customization setup screen, where you can select **When Refueled, When Ignition Is Turned Off, Manual Reset, or Exit**.
5. Press the  button and select **When Refueled**, then press the **ENTER** button.
  - The **When Refueled** screen appears, then the display returns to the customization menu screen.



6. Press the  button until  appears on the display, then press the **ENTER** button.
7. Repeat Step 6 until you return to the normal screen.





# Controls

This chapter explains how to operate the various controls necessary for driving.

<b>Clock</b> .....	186
<b>Locking and Unlocking the Doors</b>	
Key .....	188
Low Keyless Remote Signal Strength* .....	190
Locking/Unlocking the Doors from the Outside .....	191
Locking/Unlocking the Doors from the Inside .....	201
Childproof Door Locks .....	202
Auto Door Locking/Unlocking* .....	203
<b>Hatch</b> .....	204
<b>Security System</b>	
Immobilizer System .....	207
Security System Alarm .....	208
Ultrasonic Sensors* .....	210

Super Locking* .....	211
<b>Opening and Closing the Windows</b> ....	212
<b>Sunroof*</b> .....	216
<b>Operating the Switches Around the Steering Wheel</b>	
Ignition Switch* .....	218
ENGINE START/STOP Button* .....	219
Ignition Switch and Power Mode Comparison .....	222
Turn Signals .....	223
Light Switches .....	224
Front* and Rear* Fog Lights .....	227
Daytime Running Lights .....	229
Auto High-Beam* .....	230
Wipers and Washers .....	233

Brightness Control .....	237
Rear Demister/Heated Door Mirror* Button .....	238
Adjusting the Steering Wheel .....	239
<b>Adjusting the Mirrors</b>	
Interior Rearview Mirror .....	240
Power Door Mirrors .....	241
<b>Adjusting the Seats</b> .....	243
<b>Interior Lights/Interior Convenience Items</b>	
Interior Lights .....	252
Interior Convenience Items .....	254
<b>Heating System*</b> .....	270
<b>Climate Control System*</b> .....	275

\* Not available on all models

# Clock

## Adjusting the Clock





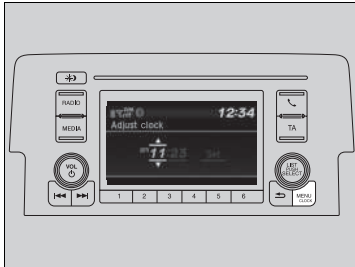

You can adjust the time in the clock display with the ignition switch in ON \*1.

### Adjusting the Time







#### Models with colour audio system

##### Using the MENU/CLOCK button

1. Press and hold the **MENU/CLOCK** button.
  - ▶ **Adjust clock** is selected.
2. Rotate  to change hour, then press .
3. Rotate  to change minute, then press .
4. To enter the selection, rotate  and select **Set**, then press .

#### Models with Display Audio

##### Using the Settings menu on the audio/information screen

1. Select **Settings**.
2. Select **Clock**.
3. Select **Clock Adjustment**.
4. Select  or  to change hour.
5. Select  or  to change minute, then select **OK**.

\* 1: Models with the keyless access system have an **ENGINE START/STOP** button instead of an ignition switch.

\* Not available on all models

### Adjusting the Clock

You can customize the clock display to show the 12 hour clock or 24 hour clock.

▶ **Customized Features\*** P. 171, 388, 396

#### Models without colour audio system

You cannot adjust the time while the vehicle is moving.

#### Models with navigation system

The clock is automatically updated through the audio system.

### Using the MENU/CLOCK button

These indications are used to show how to operate the selector knob.

Rotate  to select.

Press  to enter.

### Using the Settings menu on the audio/information screen

You can turn the clock display on and off.



▶ **Customized Features** P. 396

You can also adjust the clock by touching the clock displayed on the upper right corner of the display.

1. Touch the clock on the display for a few seconds.

2. Select **Clock Adjustment**.



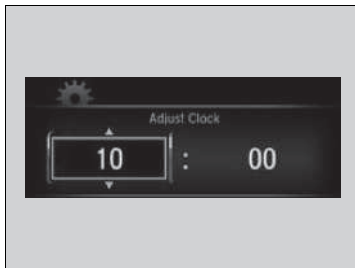

3. Select  or  to change hour.

4. Select  or  to change minute, then select **OK**.



#### Models without audio system

#### ■ Using the settings menu on the driver information interface

1. Press the  button to select , then press the **ENTER** button.
2. Press the  button until **Clock Setup** appears on the display.
3. Press the **ENTER** button.
4. Press the **ENTER** button to select **Adjust Clock**.
5. Press the  button to change hour, then press the **ENTER** button.
6. Press the  button to change minute, then press the **ENTER** button.
  - ▶ The display will return to the normal screen.

# Locking and Unlocking the Doors

## Key

This vehicle comes with the following keys:

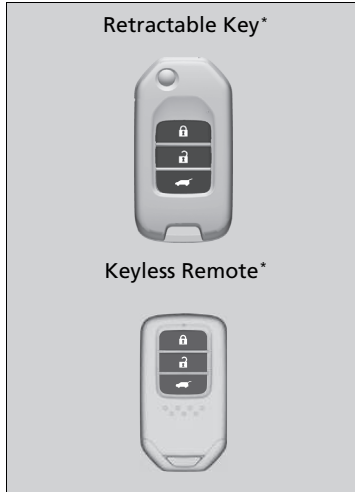

Use the keys to start and stop the engine, and to lock and unlock all the doors and hatch. You can also use the remote transmitter to lock and unlock all the doors and hatch.

### Key

All the keys have an immobilizer system. The immobilizer system helps to protect against vehicle theft.

#### Immobilizer System P. 207

Follow the advice below to prevent damage to the keys:

- Do not leave the keys in direct sunlight, or in locations with high temperature or high humidity.
- Do not drop the keys or set heavy objects on them.
- Keep the keys away from liquids, dust and sand.
- Do not take the keys apart except for replacing the battery.

If the circuits in the keys are damaged, the engine may not start, and the remote transmitter may not work.

If the keys do not work properly, have them inspected by a dealer.

### ■ Built-in Key\*

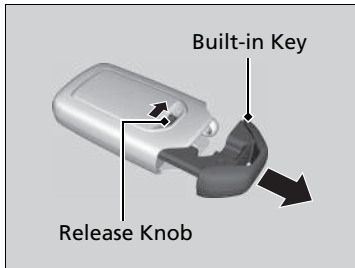

The built-in key can be used to lock/unlock the doors when the keyless remote battery becomes weak and the power door lock/unlock operation is disabled.

To remove the built-in key, slide the release knob and then pull out the key. To reinstall the built-in key, push the built-in key into the keyless remote until it clicks.

### ■ Retractable Key\*

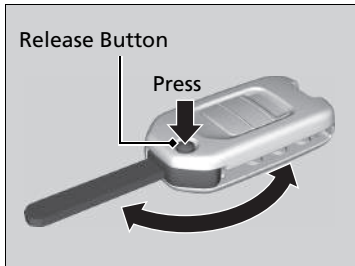

The key folds up inside the remote transmitter.

1. Press the release button to release the key out from the transmitter.
  - ▶ Make sure to fully extend the key.
2. To close the key, press the release button then push the key inside the transmitter until you hear a click.

### ▶▶ Retractable Key\*

If the key is not fully extended, the immobilizer system may not work properly, and the engine may not start. Avoid contact with the key whenever it extends or retracts.

\* Not available on all models

*Continued*

## ■ Key Number Tag

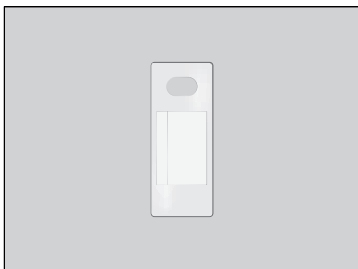

Contains a number that you will need if you purchase a replacement key.

## Low Keyless Remote Signal Strength\*

The vehicle transmits radio waves to locate the keyless remote when locking/unlocking the doors and hatch, or to start the engine.

In the following cases, locking/unlocking the doors and hatch, or starting the engine may be inhibited or operation may be unstable:

- Strong radio waves are being transmitted by nearby equipment.
- You are carrying the keyless remote together with telecommunications equipment, laptop computers, cell phones, or wireless devices.
- A metallic object is touching or covering the keyless remote.

## ☒ Key Number Tag

Keep the key number tag separate from the key in a safe place outside of your vehicle.

If you wish to purchase an additional key, contact a dealer.

If you lose your key and you cannot start the engine, contact a dealer.

## ☒ Low Keyless Remote Signal Strength\*

Communication between the keyless remote and the vehicle consumes the keyless remote's battery. Battery life is about two years, but this varies depending on regularity of use.

The battery is consumed whenever the keyless remote is receiving strong radio waves. Avoid placing it near electrical appliances such as televisions and personal computers.

## Locking/Unlocking the Doors from the Outside

### ■ Using the Keyless Access System\*

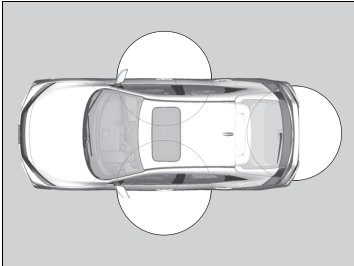

When you carry the keyless remote, you can lock/unlock the doors and hatch. You can lock/unlock the doors and hatch within a radius of about 80 cm (32 inches) of the outside door handle or hatch release button.

### » Locking/Unlocking the Doors from the Outside

If the interior light switch is in the door activated position, the interior light comes on when you unlock the doors.

No doors opened: The light fades out after 30 seconds.

Doors relocked: The light goes off immediately.

➤ **Interior Lights** P. 252

### » Using the Keyless Access System\*

If you do not open a door or the hatch within 30 seconds of unlocking the vehicle with the keyless access system, the doors and hatch will automatically relock.

You can lock or unlock doors using the keyless access system only when the power mode is in VEHICLE OFF.

\* Not available on all models

### ■ Locking the doors and hatch

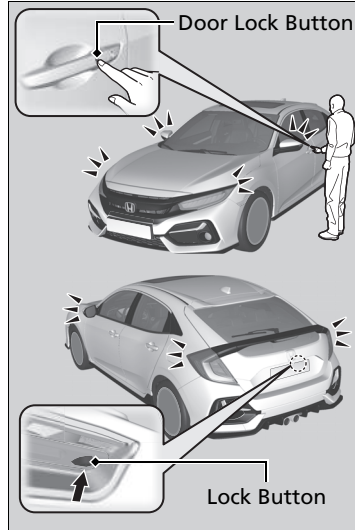

#### Models with rear fog light

Press the door lock button on the front door or on the hatch.

- ▶ Some exterior lights flash three times; all the doors and hatch lock; and the security system sets.

#### Models without rear fog light

Press the door lock button on the front door or on the hatch.

- ▶ Some exterior lights flash; the beeper sounds; all the doors and hatch lock; and the security system sets.

#### ☒ Using the Keyless Access System\*

- Do not leave the keyless remote in the vehicle when you get out. Carry it with you.
- Even if you are not carrying the keyless remote, you can lock/unlock the doors and the hatch while someone else with the remote is within range.
- The door may be unlocked if the door handle is covered with water in heavy rain or in a car wash if the keyless remote is within range.
- If you grip a front door handle wearing gloves, the door sensor may be slow to respond or may not respond by unlocking the doors.
- After locking the door, you have up to two seconds during which you can pull the door handle to confirm whether the door is locked. If you need to unlock the door immediately after locking it, wait at least two seconds before gripping the handle, otherwise the door will not unlock.
- The door may not open if you pull it immediately after gripping the door handle. Grip the handle again and confirm that the door is unlocked before pulling the handle.
- Even within the 80 cm (32 inches) radius, you may not be able to lock/unlock the doors and the hatch with the keyless remote if it is above or below the outside handle.
- The keyless remote may not operate if it is too close to the door and door glass.



## ■ Unlocking the doors and hatch

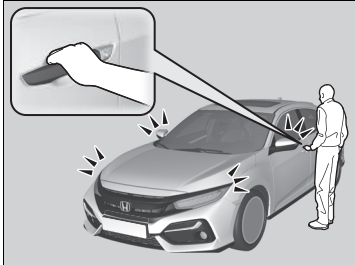

### Models with rear fog light

Grab the driver's door handle:

- ▶ The driver's door unlocks.
- ▶ Some exterior lights flash once.

Grab the front passenger's door handle:

- ▶ All doors and the hatch unlock.
- ▶ Some exterior lights flash once.

### Models without rear fog light

Grab the driver's door handle:

- ▶ The driver's door unlocks.
- ▶ Some exterior lights flash twice and the beeper sounds twice.

Grab the front passenger's door handle:

- ▶ All doors and the hatch unlock.
- ▶ Some exterior lights flash twice and the beeper sounds twice.

## ▶▶ Using the Keyless Access System\*

### Models without Display Audio

The light flash and door unlock mode settings can be customized using the driver information interface.

▶ **Customized Features\*** P. 171

### Models with Display Audio

The light flash, beep\* and door unlock mode settings can be customized using the audio/information screen.

▶ **Customized Features** P. 396

\* Not available on all models

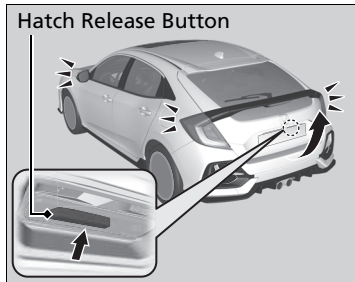

Hatch Release Button

**Models with rear fog light**

Press the hatch release button.

- ▶ The hatch unlocks.
- ▶ Some exterior lights flash once.
- **Opening/Closing the Hatch P. 205**

**Models without rear fog light**

Press the hatch release button.

- ▶ The hatch unlocks.
- ▶ Some exterior lights flash twice and the beeper sounds twice.
- **Opening/Closing the Hatch P. 205**

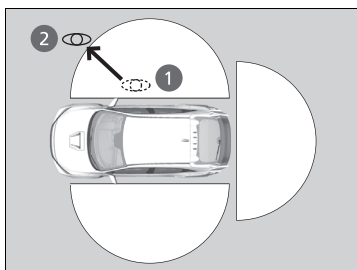
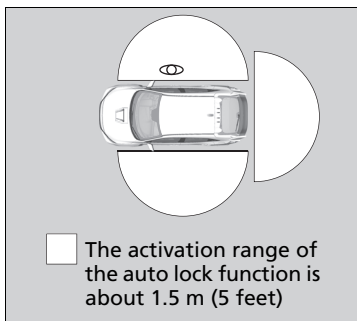

■ **Locking the doors and hatch (Walk away auto lock\*)**

When you walk away from the vehicle while carrying the keyless remote, the doors and hatch will automatically lock.

The auto lock function activates when all doors and hatch are closed, and the keyless remote is within about 1.5 m (5 feet) radius of the outside door handle.

Exit vehicle while carrying keyless remote and close door(s).

1. While within about 1.5 m (5 feet) radius of the vehicle.

▶ The beeper sounds; the auto lock function will be activated.

2. Carry the keyless remote beyond about 1.5 m (5 feet) from the vehicle and remain outside this range for 2 or more seconds.

▶ Some exterior lights flash; the beeper sounds; all doors and hatch will then lock.

▣ Locking the doors and hatch (Walk away auto lock\*)

The auto lock function is set to OFF as the factory default setting. The auto lock function can be set to ON using the audio/information screen.

If you set the auto lock function to ON using the audio/information screen, only the remote transmitter that was used to unlock the driver's door prior to the setting change can activate auto lock.

▶ **Customized Features P. 396**

After the auto lock function has been activated, when you stay within the locking/unlocking operation range, the indicator on the keyless remote will continue to flash until the doors are locked.

When you stay beside the vehicle within the operation range, the doors and hatch will automatically lock approximately 30 seconds after the auto lock function activating beeper sounds.

When you open a door or the hatch after the auto lock function activating beeper sounds, the auto lock function will be delayed until all doors and hatch are closed.

Under the following circumstances, the auto lock function will not activate:

- The remote is inside the vehicle.
  - ▶ The beeper will not sound.
- The remote is taken out of its operational range before all the doors and hatch are closed.
  - ▶ The beeper will sound.

\* Not available on all models

To temporarily deactivate the function:

1. Set the power mode to OFF.
2. Open the driver's door.
3. Using the master door lock switch, operate the lock as follows:  
Lock → Unlock → Lock → Unlock.  
► The beeper sounds and the function is deactivated.

To restore the function:

- Set the power mode to ON.
- Lock the vehicle without using the auto lock function.
- With the keyless remote on you, move out of the auto lock function operation range.
- Open any door.

▣ Locking the doors and hatch (Walk away auto lock\*)

The auto lock function does not operate when any of the following conditions are met.

- The keyless remote is inside the vehicle.
- A door, hatch or the bonnet is not closed.
- The power mode is set to any mode other than OFF.
- The keyless remote is not located within a radius of about 1.5 m (5 feet) from the vehicle when you get out of the vehicle and close the doors.

**Auto lock function operation stop beeper**

After the auto lock function has been activated, the auto lock operation stop beeper sounds for approximately two seconds in the following cases.

- The keyless remote is put inside the vehicle through a window.
- You are located too close to the vehicle.
- The keyless remote is put inside the hatch.

If the warning beeper sounds, check that you are carrying the keyless remote. Then, open/close a door and confirm the auto lock activation beeper sounds once.

## ■ Using the Remote Transmitter

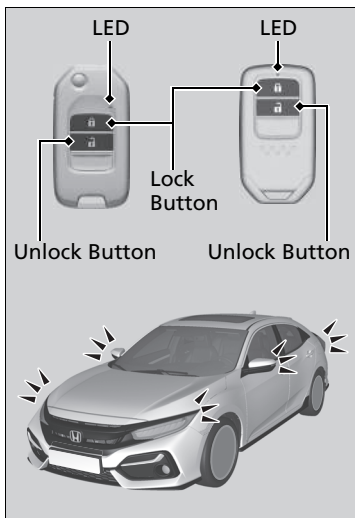

### ■ Locking the doors and hatch

#### Models with rear fog light

Press the lock button.

- ▶ Some exterior lights flash three times, all the doors and hatch lock, and the security system sets.

#### Models without rear fog light

Press the lock button.

#### Once:

- ▶ Some exterior lights flash, all the doors and hatch lock, and the security system sets.

#### Twice (within five seconds after the first push):

- ▶ The beeper sounds and verifies the security system is set.

### ▣ Using the Remote Transmitter

If you do not open a door or the hatch within 30 seconds of unlocking the vehicle with the remote transmitter, the doors and hatch will automatically relock.

You can change the relock timer setting.

➔ **Customized Features\*** P. 171, 396

#### Models without keyless access system

The remote transmitter will not work when the key is in the ignition switch.

#### Models with keyless access system

You can lock or unlock doors using the remote transmitter only when the power mode is in VEHICLE OFF.

#### Models with keyless access system

##### Right-hand drive type

##### Models with rear fog light

You cannot lock any doors from the outside when the keyless remote is inside the vehicle, and the beeper sounds. If you want to lock a door while the remote is still in the vehicle, do any of the following four times:

- Press the lock button on the keyless remote.
- Turn the key in the cylinder to lock.
- Press the door lock button on the door handle or the hatch.

#### All models

The remote transmitter uses low-power signals, so the operating range may vary depending on the surroundings.

\* Not available on all models

## ■ Unlocking the doors and hatch

### Models with rear fog light

Press the unlock button.

#### Once:

- ▶ Some exterior lights flash once, and the driver's door unlocks.

#### Twice:

- ▶ The remaining doors and hatch unlock.

### Models without rear fog light

Press the unlock button.

#### Once:

- ▶ Some exterior lights flash twice, and the driver's door unlocks.

#### Twice:

- ▶ The remaining doors and hatch unlock.

## ☒ Using the Remote Transmitter

The remote will not lock the vehicle when a door is open.

If the distance at which the remote transmitter works varies, the battery is probably low.

If the LED does not come on when you press a button, the battery is dead.

☒ **Replacing the Button Battery** P. 727

You can customize the door unlock mode setting.

☒ **Customized Features\*** P. 171, 396

## ■ Locking/Unlocking the Doors Using a Key

If the lock or unlock button of the remote transmitter does not work, use the key instead.

### ➤ Replacing the Button Battery P. 727

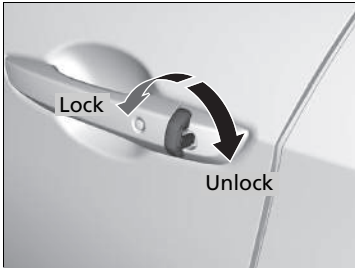

Fully insert the key and turn it.

### ▣ Locking/Unlocking the Doors Using a Key

When you lock the driver's door with the key, all the other doors and hatch lock at the same time.

When unlocking, the driver's door unlocks first.

Turning the key a second time within a few seconds does not unlock the remaining doors and the hatch.

Unlocking the doors with the key causes the security system to alarm. Always unlock the doors with the remote transmitter.

## ■ Locking a Door Without Using a Key

If you do not have the key on you, or if for some reason you cannot lock a door using the key, you can lock the door without it.

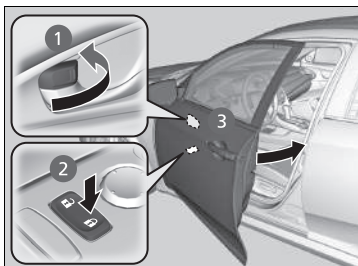

### ■ Locking the driver's door

Push the lock tab forward **1** or push the master door lock switch in the lock direction **2**, then pull and hold the outside door handle **3**. Close the door, then release the handle.

### ■ Locking the passenger's doors

Push the lock tab forward and close the door.

## ■ Lockout prevention system

### Models without keyless access system

The doors and hatch cannot be locked when the key is in the ignition switch.

### Models with keyless access system

The doors and hatch cannot be locked when the keyless remote is inside the vehicle.

## ☒ Locking a Door Without Using a Key

When you lock the driver's door, all the other doors and hatch lock at the same time.

Before locking a door, make sure that the key is not inside the vehicle.



## Locking/Unlocking the Doors from the Inside

### ■ Using the Lock Tab

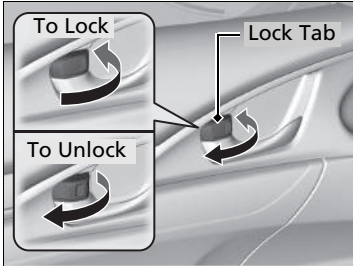

■ **Locking a door**  
Push the lock tab forward.

■ **Unlocking a door**  
Pull the lock tab rearward.

### ■ Unlocking Using the Front Door Inner Handle

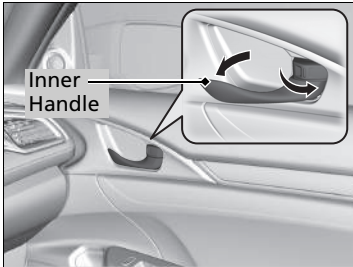

Pull the front door inner handle.  
▶ The door unlocks and opens in one motion.

### ▣ Using the Lock Tab

When you lock the door using the lock tab on the driver's door, all the other doors and the hatch lock at the same time.

When you unlock the door using the lock tab on the driver's door, only the driver's door will unlock.

### ▣ Unlocking Using the Front Door Inner Handle

The front door inner handles are designed to allow front seat occupants to open the door in one motion. However, this feature requires that front seat occupants never pull a front door inner handle while the vehicle is in motion.

Children should always ride in a rear seat where childproof door locks are provided.

▣ **Childproof Door Locks** P. 202

### ■ Using the Master Door Lock Switch

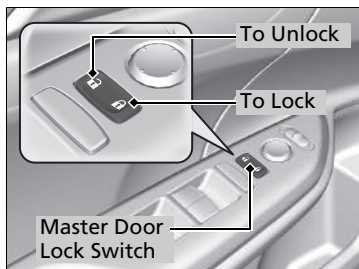

Press the master door lock switch in as shown to lock or unlock all the doors and the hatch.

### Childproof Door Locks

The childproof door locks prevent the rear doors from being opened from the inside regardless of the position of the lock tab.

### ■ Setting the Childproof Door Locks

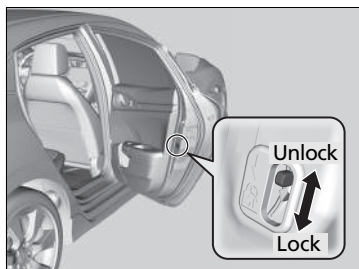

Slide the lever in the rear door to the lock position, and close the door.

#### ■ When opening the door

Open the door using the outside door handle.

#### ☒ Using the Master Door Lock Switch

When you lock/unlock either of the front doors using the master door lock switch, all the other doors and the hatch lock/unlock at the same time.

#### ☒ Childproof Door Locks

To open the door from the inside when the childproof door lock is on, put the lock tab in the unlock position, lower the rear window, put your hand out of the window, and pull the outside door handle.

## Auto Door Locking/Unlocking\*

Your vehicle locks all doors or unlocks the driver's door automatically when a certain condition is met.

### ■ Auto Door Locking

#### ■ Drive lock mode

All doors and the hatch lock when the vehicle's speed reaches about 15 km/h.

### ■ Auto Door Unlocking

#### ■ Power mode unlock mode

The driver's door unlocks when the power mode is out of ON. The settings can be changed to unlock all doors and the hatch.

### ▣ Auto Door Locking/Unlocking\*

You can turn off or change to another auto door locking/unlocking setting using the audio/information screen.

▣ **Customized Features** P. 396

\* Not available on all models

# Hatch

## Precautions for Opening/Closing the Hatch

Always make sure individuals and objects are clear of the hatch before opening or closing it.

- Open the hatch all the way.
  - ▶ If it is not fully opened, the hatch may begin to close under its own weight.
- Be careful when it is windy. The wind may cause the hatch to close.

Keep the hatch closed while driving to:

- ▶ Avoid possible damage.
- ▶ Prevent exhaust gas from leaking into the vehicle.
  - ☒ **Carbon Monoxide Gas** P. 104

### ☒ Precautions for Opening/Closing the Hatch

#### **⚠ WARNING**

Anyone caught in the path of a hatch that is being opened or closed can be seriously injured.

**Make sure that all people are clear of the hatch before opening or closing it.**

Be careful not to hit your head on the hatch or to put your hands between the hatch and the luggage area when closing the hatch.

When you are storing or picking up luggage from the luggage area while the engine is idling, do not stand in front of the exhaust pipe. You may get burned.

Do not allow any passenger in the luggage space. They may get hurt during hard braking, a sudden acceleration, or a crash.

## Opening/Closing the Hatch

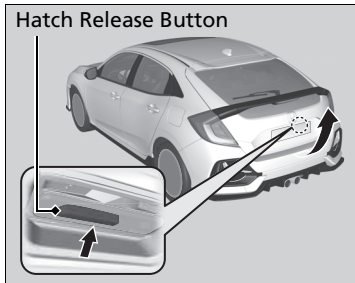

When all the doors are unlocked or press the hatch unlock button on the remote transmitter, the hatch is unlocked. Press the hatch release button and lift open the hatch.

### Models with keyless access system

If you are carrying the keyless remote, you do not have to unlock the hatch before opening it.

### All models

To close the hatch, grab the inner handle, pull the hatch down, and push it closed from outside.



If you close the hatch when the driver's door is locked, the hatch locks automatically.

### Models with rear fog light

- ▶ Some exterior lights flash three times.

### Models without rear fog light

- ▶ Some exterior lights flash.

## Opening/Closing the Hatch

### Models with keyless access system

- Do not leave the keyless remote in the vehicle when you get out. Carry it with you.
- Even if you are not carrying the keyless remote, you can unlock the hatch while someone else with the remote is within range.
- Do not leave the keyless remote inside the luggage area and close the hatch when all the doors are locked. The beeper sounds and the hatch cannot be locked.

### ■ Using the Remote Transmitter

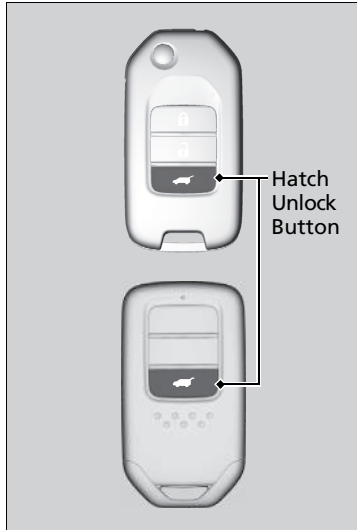

Press the hatch unlock button to unlock the hatch.

### ☑ Using the Remote Transmitter

If you have unlocked and opened the hatch using the remote transmitter, when closing, the hatch locks automatically.

## Immobilizer System

The immobilizer system prevents a key that has not been pre-registered from starting the engine. Each key contains electronic transmitters that use electronic signals to verify the key.

Pay attention to the following when inserting the key into the ignition switch\* or pressing the **ENGINE START/STOP** button\*:

- Do not allow objects that emit strong radio waves near the ignition switch\* or the **ENGINE START/STOP** button\*.
- Make sure the key is not covered by or touching a metal object.
- Do not bring a key from another vehicle's immobilizer system near the ignition switch\* or the **ENGINE START/STOP** button\*.
- Do not put the key near magnetic items. Electronic devices, such as televisions and audio systems emit strong magnetic fields. Note that even a key chain can become magnetic.

\* Not available on all models

### Immobilizer System

#### NOTICE

Leaving the key in the vehicle can result in theft or accidental movement of the vehicle. Always take the key with you whenever you leave the vehicle unattended.

Do not alter the system or add other devices to it. Doing so may damage the system and make your vehicle inoperable.

If the system repeatedly does not recognise the coding of your key, contact a dealer. If you have lost your key and cannot start your vehicle, contact a dealer.

#### Right-hand drive type

#### Models with rear fog light

Apply and hold the brake pedal before turning the vehicle on the first time after the battery has been disconnected.

## Security System Alarm

The security system alarm activates when the hatch, bonnet or doors are forcibly opened. The alarm does not activate if the hatch or doors are opened with the remote transmitter or keyless access system\*.

### ■ When the security system alarm activates

The horn sounds intermittently, and some exterior lights flash.

### ■ To deactivate the security system alarm

Unlock the vehicle using the remote transmitter or keyless access system\*, or turn the ignition switch to ON **II**\*<sup>1</sup>. The system, along with the horn and flashing lights, is deactivated.

### ■ Setting the security system alarm

The security system alarm automatically sets when the following conditions have been met:

- The ignition switch is in LOCK **0**\*<sup>1</sup>, and the key has been removed from the ignition switch.
- The bonnet is closed.
- All doors and the hatch are locked from outside with the key, remote transmitter or keyless access system\*.

### ■ When the security system alarm sets

The security system alarm indicator in the instrument panel blinks and the blinking interval changes after about 15 seconds.

\* 1: Models with the keyless access system have an **ENGINE START/STOP** button instead of an ignition switch.

\* Not available on all models

### ☒ Security System Alarm

Do not alter the system or add other devices to it. Doing so may damage the system and make your vehicle inoperable.

The security system alarm will continue for approximately 5 minutes before the security system deactivates.

The system will go through ten 30-second cycles, during which the horn will sound and an emergency indicator will flash.

Depending on circumstances, the security system may continue operating for more than 5 minutes.

Do not set the security system alarm when someone is in the vehicle or a window is open. The system can accidentally activate when:

- Unlocking the door with the lock tab.
- Opening the bonnet with the bonnet release.

If the battery goes dead after you have set the security system alarm, the security alarm may go off once the battery is recharged or replaced. If this occurs, deactivate the security system alarm by unlocking a door using the remote transmitter or keyless access system\*.

If you unlock a door with the key while the security system is activated, the alarm will go off.



### ■ To cancel the security system alarm

The security system alarm is cancelled when the vehicle is unlocked using the remote transmitter or keyless access system\*, or when the ignition switch is turned to ON \*1. The security system alarm indicator goes off at the same time.

\*1: Models with the keyless access system have an **ENGINE START/STOP** button instead of an ignition switch.

\* Not available on all models

### ▣ Security System Alarm

#### ▣ Models with ultrasonic sensors

The system may accidentally activate such as when:

- The vehicle is parked in an automated garage.
- The vehicle is being washed with highly pressurized water or being put through an automated car wash.
- The vehicle is being transported by train, ferry or trailer.
- The vehicle is subjected to heavy rain or stormy weather.
- Ice is being removed from the vehicle.

You can use ultrasonic sensor OFF button not to accidentally activate the security system alarm.

 **Ultrasonic Sensors\*** P. 210



## Ultrasonic Sensors\*

The ultrasonic sensors activate only when the security system alarm is set. If the sensors detect an intruder moving around inside or entering the interior of the vehicle through a window, the sensor will activate the alarm.

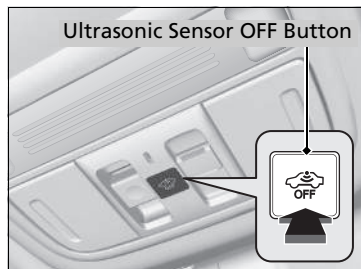
### ■ To set the security system alarm without activating the ultrasonic sensors



You can set the security system alarm without activating the ultrasonic sensor.

To turn off the ultrasonic sensor system, press the ultrasonic sensor OFF button after you remove the key from the ignition switch, or with the key in the ACCESSORY  or LOCK  \*1.

► The  is on in red.

To turn it on again, press the ultrasonic sensor OFF button.



Ultrasonic sensors are turned on every time you set the security system alarm, even if you turned it off the last time.

### ▣ Ultrasonic Sensors\*

Whether the ultrasonic sensors have been activated or not, the security system can only be turned off by the remote transmitter or keyless access system\*, not the key.

It is possible to confirm whether the vehicle security system was activated without your knowledge. If the security system has been activated, the  will blink for 5 minutes after you unlock the door and disable the system.

If, however, you start the engine, the  will stop blinking after 5 seconds.

If the ultrasonic sensor is malfunctioning or there is another problem, the  will come on for 5 minutes after you unlock the door and disable the system. If, however, you start the engine, the  will shut off.

The security system may accidentally activate by ultrasonic sensors such as when:

- Someone is in the vehicle.
- A window is open.
- Accessories or clothes are hanging in the vehicle.

\* 1: Models with the keyless access system have an **ENGINE START/STOP** button instead of an ignition switch.

\* Not available on all models

## Super Locking\*

The super locking function disables the lock tabs on all doors.

### ■ To activate the super locking function

- Turn the key in the driver's door towards the vehicle front twice within five seconds.
- Press the lock button on the remote transmitter twice within five seconds.

#### Models with keyless access system

- Press the door lock button on the door handle or the hatch twice within five seconds.

### ■ To cancel the super locking function

Unlock the driver's door with the remote transmitter or keyless access system\*.

#### Super Locking\*

### WARNING

No one must be inside the vehicle with the super locking set. Persons locked in can get seriously sick or die from the heat built inside the vehicle if left in the sun.

Make sure there is no one inside the vehicle before setting the super locking.

Do not unlock the door using the key. The security system alarm goes off.

Once the super locking function has been enabled, it will remain enabled even if you unlock the hatch.

\* Not available on all models

# Opening and Closing the Windows

## Opening/Closing the Power Windows

The power windows can be opened and closed when the ignition switch is in ON <sup>\*1</sup>, using the switches on the doors.

The driver's side switches can be used to open and close all the windows. The power window lock button on the driver's side must be switched off (indicator off) to open and close the windows from anywhere other than the driver's seat.

When the power window lock button is pressed, the indicator comes on and you can only operate the driver's window. Turn the power window lock button on if a child is in the vehicle.

### Opening/Closing the Power Windows

#### **WARNING**

Closing a power window on someone's hands or fingers can cause serious injury.

Make sure your passengers are away from the windows before closing them.

**WARNING:** Always take the ignition key with you whenever you leave the vehicle alone or with other occupants.

The power windows can be operated for up to 10 minutes after you turn the ignition switch to LOCK <sup>\*1</sup>.

#### **Auto-open/close function on front windows**

Opening either front door cancels this function.

#### **Auto-open/close function on all windows**

Closing the driver's door cancels this function.

#### **Auto Reverse**

If a power window senses resistance when closing automatically, it will stop closing and reverse direction.

The driver's window auto reverse function is disabled when you continuously pull up the switch.

The auto reverse function stops sensing when the window is almost closed to ensure that it fully closes.

### Opening/Closing the Windows with Auto-Open/Close Function

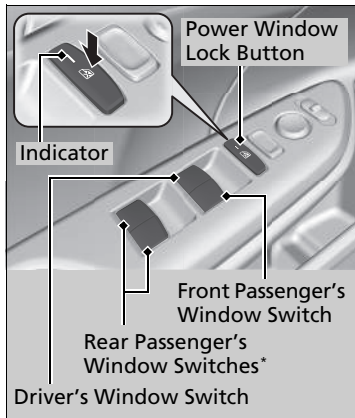

#### ■ Manual operation

**To open:** Push the switch down lightly, and hold it until the desired position is reached.

**To close:** Pull the switch up lightly, and hold it until the desired position is reached.

#### ■ Automatic operation

**To open:** Push the switch down firmly.

**To close:** Pull the switch up firmly.

The window opens or closes completely. To stop the window at any time, push or pull the switch briefly.

\*1: Models with the keyless access system have an **ENGINE START/STOP** button instead of an ignition switch.

\* Not available on all models

### ■ Opening/Closing Windows without Auto-Open/Close Function \*

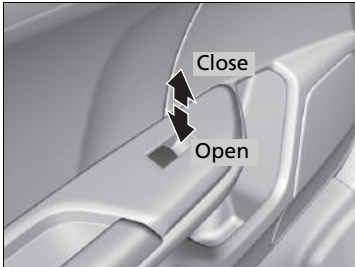

**To open:** Push the switch down.

**To close:** Pull the switch up.

Release the switch when the window reaches the desired position.

\* Not available on all models

Auto-open/close function on all windows

■ Opening/Closing the Windows with the Remote

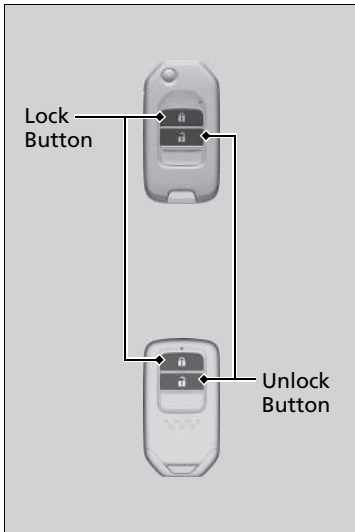

**To open:** Press the unlock button, and then within 10 seconds, press it again and hold it.

**To close:** Press the lock button, and then within 10 seconds, press it again and hold it.

If the windows stop midway, repeat the procedure.

☒ Opening/Closing the Windows with the Remote

If you open/close the windows with the remote, the sunroof\* will open/close automatically along with them.

Auto-open/close function on all windows

## ■ Closing the Windows with the Key



**To close:** Lock the driver's door with the key. Within 10 seconds of returning the key to the central position, turn the key in the lock direction and hold it there.

Release the key to stop the windows at the desired position. If you want further adjustment, repeat the same operation.

## » Closing the Windows with the Key

If you close the windows with the key, the sunroof\* will close automatically along with them.

\* Not available on all models

# Sunroof\*

## Opening/Closing the Sunroof

You can operate the sunroof when the power mode is in ON. Use the switch in the front of the ceiling to open and close the sunroof.

### ■ Using the Sunroof Switch

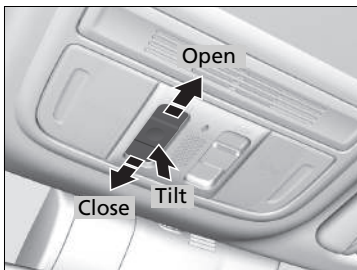

#### ■ Automatic operation

**To open:** Pull the switch back firmly.

**To close:** Push the switch forward firmly.

The sunroof automatically opens or closes all the way. To stop the sunroof midway, pull or push the switch briefly.

#### ■ Manual operation

**To open:** Pull the switch back lightly, and hold it until the desired position is reached.

**To close:** Push the switch forward lightly, and hold it until the desired position is reached.

#### ■ Tilting the sunroof up

**To tilt:** Push on the centre of the sunroof switch.

**To close:** Push the switch forward firmly, then release.

☒ Sunroof\*

## ⚠ WARNING

Opening or closing the sunroof on someone's hands or fingers can cause serious injury.

**Make sure all hands and fingers are clear of the sunroof before opening or closing it.**

**WARNING:** Always take the ignition key with you whenever you leave the vehicle alone or with other occupants.

### NOTICE

Opening the sunroof in below freezing temperature or when it is covered with snow or ice can damage the sunroof panel or motor.

The sunroof can be operated for up to 10 minutes after you set the power mode to OFF. Closing the driver's door cancels this function.



▣ Opening/Closing the Sunroof

When resistance is detected, the auto reverse function causes the sunroof to change directions, then stop. Auto reverse stops sensing when the sunroof is almost closed to ensure that it fully closes. Make sure that all objects, including fingers, are clear of the sunroof.

You can use the remote transmitter or the key to operate the sunroof.

- ▣ **Opening/Closing the Windows with the Remote** P. 214
- ▣ **Closing the Windows with the Key** P. 215

# Operating the Switches Around the Steering Wheel

## Ignition Switch \*

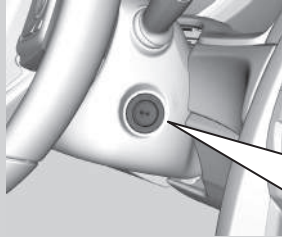

- 0** LOCK: Insert and remove the key in this position.
- I** ACCESSORY: Operate the audio system\* and other accessories in this position.
- II** ON: This is the position when driving.
- III** START: This position is for starting the engine. The switch returns to ON **II** when you let go of the key.

### Ignition Switch \*

#### Manual transmission models

## ⚠ WARNING

Removing the key from the ignition switch while driving locks the steering. This can cause you to lose control of the vehicle.



Remove the key from the ignition switch only when parked.

#### Continuously variable transmission models

You cannot take the key out unless the shift lever is in **P**.

#### All models

If you open the driver's door when the key is in LOCK **0** or ACCESSORY **I**, the following messages appear on the driver information interface:

- In LOCK **0**: 
- In ACCESSORY **I**: 

If the key won't turn from LOCK **0** to ACCESSORY **I**, turn the key while moving the steering wheel left and right. The steering wheel will unlock, allowing the key to turn.

## ENGINE START/STOP Button \*

### ■ Changing the Power Mode

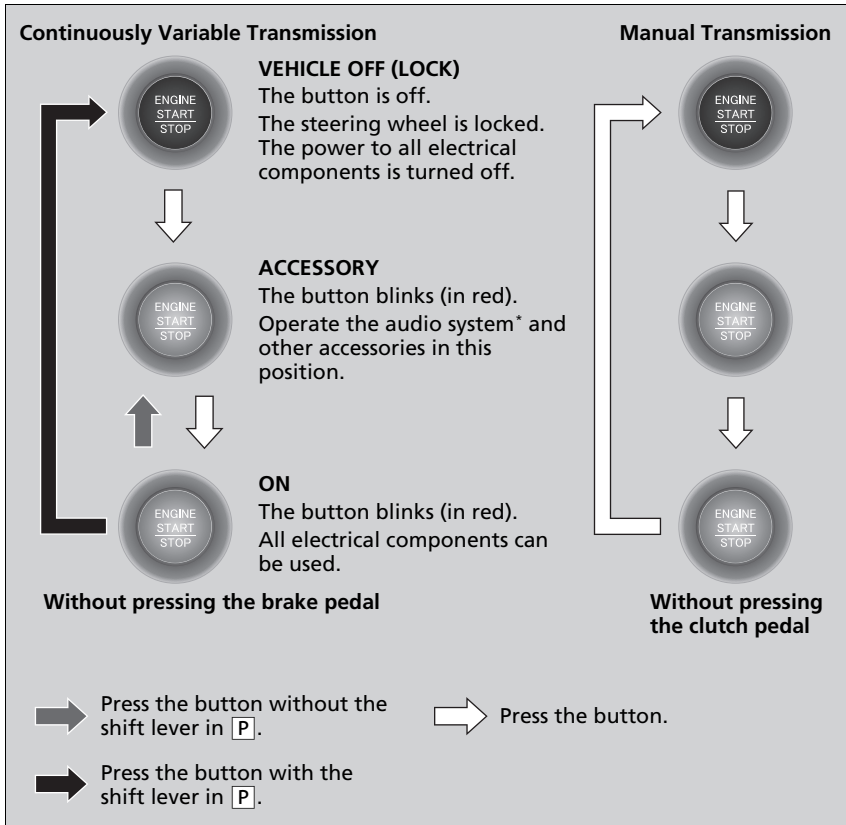

\* Not available on all models

Continued

### ▶▶ ENGINE START/STOP Button \*

#### ENGINE START/STOP Button Operating Range

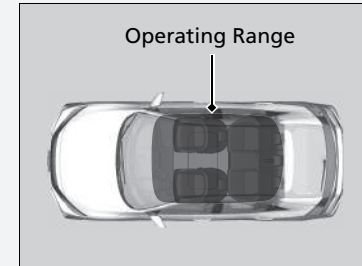

You can start the engine when the keyless remote is inside the vehicle.  
The engine may also run if the keyless remote is close to the door or window, even if it is outside the vehicle.

ON mode:  
The **ENGINE START/STOP** button is on (in red), if the engine is running.

If the battery of the keyless remote is getting low, the engine may not start when you press the **ENGINE START/STOP** button. If the engine does not start, refer to the following link.

➡ **If the Keyless Remote Battery is Weak**

P. 770

Do not leave the power mode in ACCESSORY or ON when you get out.

### ■ Automatic Power Off

If you leave the vehicle for 30 to 60 minutes with the transmission in **P** (Continuously Variable Transmission) and the power mode in ACCESSORY, the vehicle automatically goes into the mode similar to VEHICLE OFF (LOCK) to avoid draining the battery.

When in this mode:

The steering wheel does not lock.

You cannot lock or unlock doors with the remote transmitter or the keyless access system.

Press the **ENGINE START/STOP** button twice to switch the mode to VEHICLE OFF (LOCK).

### ■ Power Mode Reminder

If you open the driver's door when the power mode is set to ACCESSORY, a warning beep sounds.

## ■ Keyless Remote Reminder

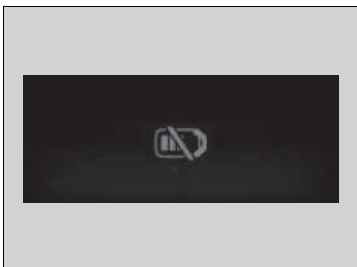

Warning buzzers may sound from inside and/or outside the vehicle to remind you that the keyless remote is out of the vehicle. If the buzzer continues even after the remote is put back inside, place it to be within its operational range.

### ■ When the power mode is in ON

If the keyless remote is taken out of the vehicle, and all the doors are closed, a warning buzzer sounds from both inside and outside the vehicle. A warning message on the driver information interface notifies the driver inside that the remote is outside of the vehicle.

### ■ When the power mode is in ACCESSORY

If the keyless remote is taken out of the vehicle, and all the doors are closed, a warning buzzer sounds from outside the vehicle.

## ▣ Keyless Remote Reminder

When the keyless remote is within the system's operational range, and the driver's door is closed, the warning function cancels.

If the keyless remote is taken out of the vehicle after the engine has been started, you can no longer change the **ENGINE START/STOP** button mode or restart the engine. Always make sure if the remote is in your vehicle when you operate the **ENGINE START/STOP** button.

Removing the keyless remote from the vehicle through a window does not activate the warning buzzer.

Do not put the keyless remote on the dashboard or in the glove box. It may cause the warning buzzer to go off. Under some other conditions that can prevent the vehicle from locating the remote, the warning buzzer may also go off even if the remote is within the system's operational range.

## Ignition Switch and Power Mode Comparison

Ignition Switch Position	LOCK 0 (with/without the key)	ACCESSORY I	ON II	START III
Without Keyless Access System	<ul style="list-style-type: none"> <li>• Engine is turned off and power is shut down.</li> <li>• The steering wheel is locked.</li> <li>• No electrical components can be used.</li> </ul>	<ul style="list-style-type: none"> <li>• Engine is turned off.</li> <li>• Some electrical components such as the audio system* and the accessory power socket can be operated.</li> </ul>	<ul style="list-style-type: none"> <li>• Normal key position while driving.</li> <li>• All electrical components can be used.</li> </ul>	<ul style="list-style-type: none"> <li>• Use this position to start the engine.</li> <li>• The ignition switch returns to the ON II position when you release the key.</li> </ul>
Power Mode	VEHICLE OFF (LOCK)	ACCESSORY	ON	START
With Keyless Access System and <b>ENGINE START/STOP</b> Button	Button-Off <ul style="list-style-type: none"> <li>• Engine is turned off and power is shut down.</li> <li>• The steering wheel is locked.</li> <li>• No electrical components can be used.</li> </ul>	Button-Blinking <ul style="list-style-type: none"> <li>• Engine is turned off.</li> <li>• Some electrical components such as the audio system* and the accessory power socket can be operated.</li> </ul>	Button-Blinking (engine is turned off) On (engine is running) <ul style="list-style-type: none"> <li>• All electrical components can be used.</li> </ul>	Button-On <ul style="list-style-type: none"> <li>• The mode automatically returns to ON after the engine starts.</li> </ul>

## Turn Signals

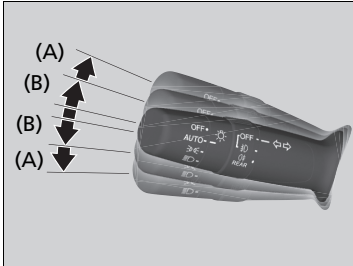

The turn signals can be used when the ignition switch is in ON <sup>\*1</sup>.

### ■ (A): Turn signal

When turning the car, push the lever up or down based on the direction you want to turn, and the turn signal will blink.

### ■ (B): One-touch turn signal

When you lightly push the lever up or down and release it, the turn signal will blink 3 times.

▶▶(A): Turn signal

The turn signal indicator on the instrument panel will blink when the external turn signal blinks.

▶▶ Indicators P. 108

\*1: Models with the keyless access system have an **ENGINE START/STOP** button instead of an ignition switch.

## Light Switches

### Manual Operation

#### Models with rear fog light

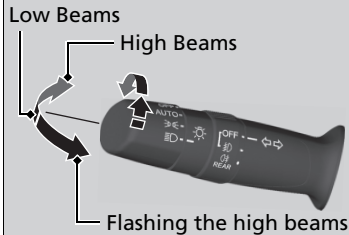

#### Models without rear fog light

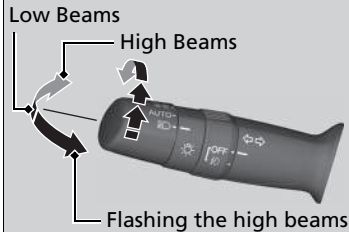

 Turns on position, side marker\*, tail, and rear licence plate lights

 Turns on headlights, position, side marker\*, tail, and rear licence plate lights

Rotating the light switch turns the lights on and off, regardless of the power mode setting or position of the ignition switch.

#### ■ High beams

Push the lever forward until you hear a click.

#### ■ Low beams

When in high beams, pull the lever back to return to low beams.

#### ■ Flashing the high beams

Pull the lever back, and release it.

#### Models with rear fog light

#### ■ Lights off

Turn the lever to **OFF** either when:

- The transmission is in **P**. (Continuously Variable Transmission models)
- The parking brake is applied.

To turn the lights on again, turn the lever to **OFF** to cancel the lights off mode. Even if you do not cancel the lights off mode, the lights come on automatically when:

- The transmission is taken out of **P** (Continuously Variable Transmission models) and the parking brake is released.
- The vehicle starts to move.

### Light Switches

#### Models with keyless access system

If you leave the power mode in VEHICLE OFF (LOCK) while the lights are on, a chime sounds when the driver's door is opened.

#### Models without keyless access system

If you remove the key from the ignition switch while the lights are on, a chime sounds when the driver's door is opened.

When the lights are on, the lights on indicator in the instrument panel will be on.

#### ➤ Lights On Indicator P. 121

Do not leave the lights on when the engine is off because it will cause the battery to discharge.

Your vehicle is equipped with the automatic headlight adjusting system that automatically adjusts the vertical angle of the low beam headlights. If you find a significant change in the vertical angle of the headlights, there may be a problem with the system. Have your vehicle checked by a dealer.

You may need to alter the headlight beam distribution.

#### ➤ Adjusting Headlight Distribution P. 561



## Automatic Operation (automatic lighting control)

### Models with rear fog light



Automatic lighting control can be used when the ignition switch is in ON \*1.

### Models with rear fog light

When the light switch is in **AUTO**, the headlights and other exterior lights will switch on and off automatically depending on the ambient brightness.

### Models without rear fog light

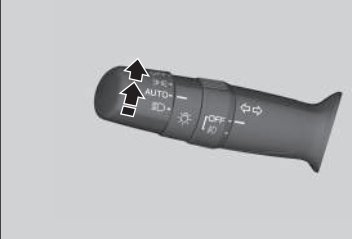

### Models without rear fog light

When you turn the light switch to **AUTO**, the headlights and other exterior lights will switch on and off automatically depending on the ambient brightness.

### All models

The headlights come on when you unlock a door in dark areas with the headlight switch in **AUTO**.

- ▶ Once you lock the door, the headlights will go off.

\*1: Models with the keyless access system have an **ENGINE START/STOP** button instead of an ignition switch.

## Automatic Operation (automatic lighting control)

We recommend that you turn on the lights manually when driving at night, in a dense fog, or in dark areas such as long tunnels or parking facilities.

The light sensor is in the location shown below. Do not cover this light sensor with anything; otherwise, the automatic lighting system may not work properly.

### Models without automatic intermittent wiper

#### Light Sensor

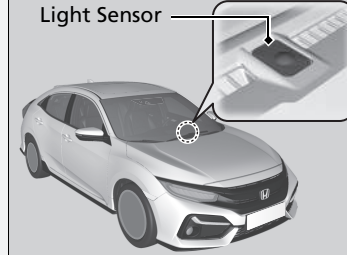

### Models with automatic intermittent wiper

#### Light Sensor

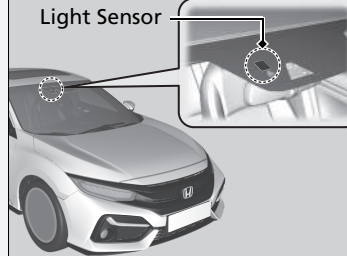

Continued

### Headlight Integration with Wipers

The headlights automatically come on when the wipers are used several times within a certain number of intervals with the headlight switch in **AUTO**.

The headlights automatically go off a few minutes later if the wipers are stopped.

### Automatic Lighting Off Feature

The headlights, all other exterior lights, and the instrument panel lights turn off 15 seconds after you remove the key or set the power mode to VEHICLE OFF (LOCK), take the remote with you, and close the driver's door.

#### Models with rear fog light

However, when the switch is in , the position lights remain on.

If you turn the ignition switch to LOCK <sup>\*1</sup> with the headlight switch on, but do not open the door, the lights turn off after 10 minutes (3 minutes, if the switch is in the **AUTO** position).

The lights turn on again when you unlock or open the driver's door. If you unlock the door, but do not open it within 15 seconds, the lights go off. If you open the driver's door, you will hear a lights on reminder chime.

\* 1: Models with the keyless access system have an **ENGINE START/STOP** button instead of an ignition switch.

\* Not available on all models

### Automatic Operation (automatic lighting control)

#### Models without rear fog light

You can adjust the auto light sensitivity as follows:

Setting	The exterior lights come on when the ambient light is at
Max	
High	
Mid	
Low	
Min	

▶ Customized Features P. 396

### Headlight Integration with Wipers

This feature activates while the headlights are off in **AUTO**.

The instrument panel brightness does not change when the headlights come on.

At dark ambient light levels, the automatic lighting control feature turns on the headlights, regardless of the number of wiper sweeps.

### Automatic Lighting Off Feature

You can change the headlight auto off timer setting.

▶ Customized Features\* P. 171, 396

## Front\* and Rear\* Fog Lights

### ■ Front fog lights

Can be used when the position lights or the headlights are on.



### ■ Rear fog light

Can be used when the headlights or the front fog lights are on.

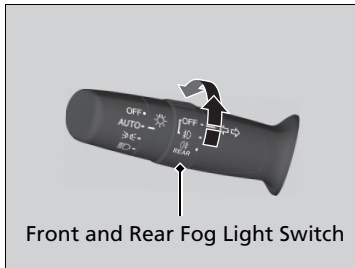

### ■ Front and Rear Fog Lights\*





#### ■ To turn the front fog lights on

Rotate the switch up from the OFF position to the  position. The  indicator comes on.

#### ■ To turn the front and rear fog lights on

Rotate the switch one position up from the  position. The  and  indicators come on.

#### ■ To turn the rear fog light on

Rotate the switch one position up from the  position and then rotate the switch one position down from the  position. The  indicator stays on.



To turn the rear fog light off, turn the headlight switch to the **OFF** position.

\* Not available on all models

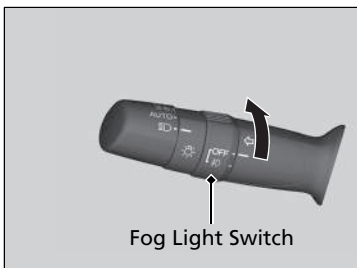
### ■ Front Fog Lights\*





#### ■ To turn the front fog lights on

Rotate the switch to the . The  indicator comes on.

### ■ Rear Fog Light\*



#### ■ To turn the rear fog light on

Rotate the switch to the . The  indicator comes on.

## Daytime Running Lights

The position/daytime running lights come on when the following conditions have been met:

- The ignition switch is in ON \*1.

**Models with rear fog light**

- The headlight switch is in **AUTO**.

**Models without rear fog light**

- The headlight switch is in **AUTO** or **OFF**.

Turning off the ignition switch or setting the power mode to VEHICLE OFF (LOCK) will turn off the daytime running lights.

The daytime running lights are off once the headlight switch is turned on, or when the headlight switch is in **AUTO** and it is getting darker outside.

\*1: Models with the keyless access system have an **ENGINE START/STOP** button instead of an ignition switch.

## Auto High-Beam\*

The front sensor camera detects the light sources ahead of the vehicle such as the lights of a preceding or oncoming vehicle, or street lights. When you are driving at night, the system automatically switches the headlights between low beam and high beam depending on the situation.

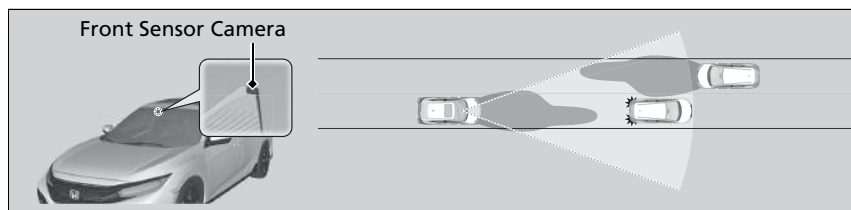

### How to Use the Auto High-Beam

When all of the following conditions have been met, the auto high-beam indicator comes on and the auto high-beam is activated.

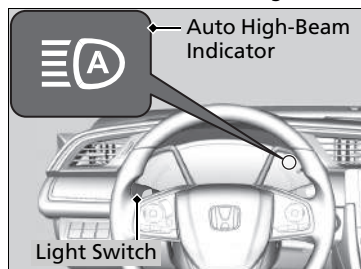

- The ignition switch is in ON \*1.
- The light switch is in **AUTO**.
- The lever is in the low beam position.
- The headlights have been automatically activated.
- It is dark outside the vehicle.

If the auto high-beam indicator does not come on even when all the conditions have been met, carry out either of the procedures below and the indicator will come on.

- Pull the lever towards you and hold it over two seconds then release it.
- Turn the light switch to  then turn the light switch to **AUTO**.

\*1: Models with the keyless access system have an **ENGINE START/STOP** button instead of an ignition switch.

\* Not available on all models

### Auto High-Beam\*

The auto high-beam system does not always operate in every situation. This system is just for assisting the driver. Always observe your surroundings and switch the headlights between high beam and low beam manually if necessary.

The range and the distance at which the camera can recognise varies depending on conditions surrounding your vehicle.

Regarding the handling of the camera mounted to the inside of the windscreen, refer to the following.

#### Front Sensor Camera P. 630

For the auto high-beam to work properly:

- Do not place an object that reflects light on the dashboard.
- Keep the windscreen around the camera clean.
- When cleaning the windscreen, be careful not to apply the windscreen cleanser to the camera lens.
- Do not attach an object, sticker or film to the area around the camera.
- Do not touch the camera lens.

If the camera receives a strong impact, or repairing of the area near the camera is required, consult a dealer.

### ■ Automatic switching between high-beam and low-beam

When auto high-beam is active, the headlights switch between high beam and low beam based on the following conditions.

#### Switching to high beam:

All of the following conditions must be met before the high beams turn on.

- Your vehicle speed is 40 km/h (25 mph) or more.
- There are no preceding or oncoming vehicle with headlights or taillights turned on.
- There are few street lights on the road ahead.



#### Switching to low beam:

One of the following conditions must be met before the low beams turn on.

- Your vehicle speed is 24 km/h (15 mph) or less.
- There is a preceding or oncoming vehicle with headlights or taillights turned on.
- There are many street lights on the road ahead.

### ■ Manual switching between high-beam and low-beam

If you want to manually switch the headlights between high beam and low beam, follow either of the procedures below. Note that when you do this, the auto high-beam indicator will turn off and the auto high-beam will be deactivated.

#### Using the lever:

Pull the lever towards you for flashing the high beams then release it or push the lever forward to the high beam position.

- ▶ To reactivate the auto high-beam, follow either of the procedures below and the auto high-beam indicator will come on.
- Pull the lever towards you and hold it over two seconds then release it.
- Turn the light switch to  and then to **AUTO** when the lever is in the low beam position.

#### Using the light switch:

Turn the light switch to .

- ▶ To reactivate the auto high-beam, turn the light switch to **AUTO** when the lever is in the low beam position, the auto high-beam indicator will come on.

#### ▣ How to Use the Auto High-Beam

In the following cases, the auto high-beam system may not switch the headlights properly or the switching timing may be changed. In case of the automatic switching operation does not fit for your driving habits, please switch the headlights manually.

- The brightness of the lights from the preceding or oncoming vehicle is intense or poor.
- Visibility is poor due to the weather (rain, snow, fog, windscreen frost, etc.).
- Surrounding light sources, such as street lights, electric billboards and traffic lights are illuminating the road ahead.
- The brightness level of the road ahead constantly changes.
- The road is bumpy or has many curves.
- A vehicle suddenly appears in front of you, or a vehicle in front of you is not in the preceding or oncoming direction.
- Your vehicle is tilted with a heavy load in the rear.
- A traffic sign, mirror, or other reflective object ahead is reflecting strong light towards the vehicle.
- The oncoming vehicle frequently disappears under roadside trees or behind median barriers.
- The preceding or oncoming vehicle is a motorcycle, bicycle, mobility scooter, or other small vehicle.

The auto high-beam system keeps the headlight low beam when:

- Windscreen wipers are operating at a high speed.
- The camera has been detected a dense fog.

## How to Turn Off the Auto High-Beam

You can turn the auto high-beam system off. If you want to turn the system off or on, turn the ignition switch to ON **II**\*1, then carry out the following procedures while the vehicle is stationary.

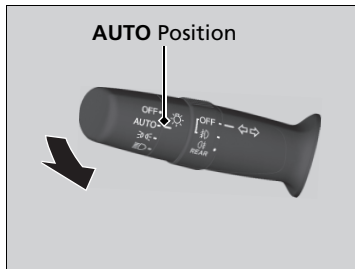

### To turn the system off:

With the light switch is in **AUTO**, pull the lever towards you and hold it for at least 40 seconds. After the auto high-beam indicator light blinks twice, release the lever.

### To turn the system on:

With the light switch is in **AUTO**, pull the lever towards you and hold it for at least 30 seconds. After the auto high-beam indicator light blinks once, release the lever.

## How to Turn Off the Auto High-Beam

If you turn the auto high-beam system off, the system does not operate until you turn the system on.

Park in a safe place before turning the system off or on.

\* 1: Models with the keyless access system have an **ENGINE START/STOP** button instead of an ignition switch.



## Wipers and Washers

### ■ Windscreen Wipers/Washers

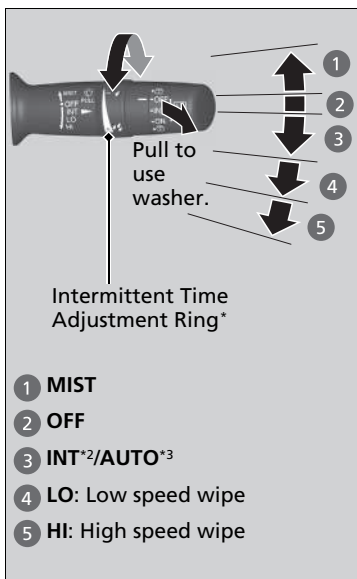

The windscreen wipers and washers can be used when the ignition switch is in ON \*1.

#### ■ MIST

The wipers run at high speed until you release the lever.

#### ■ Wiper switch (OFF, INT\*2/AUTO\*3, LO, HI)

Move the lever up or down to change the wiper settings.

#### ■ Adjusting wiper operation\*

Turn the adjustment ring to adjust the wiper operation.



Lower speed, fewer sweeps

Higher speed, more sweeps

#### ■ Washer

Sprays while you pull the lever towards you. When you release the lever for more than one second, the spray stops, the wipers sweep two or three more times to clear the windscreen, then stop.

### ▶ Wipers and Washers

#### NOTICE

Do not use the wipers when the windscreen is dry. The windscreen will get scratched, or the rubber blades will get damaged.

#### NOTICE

Turn the washers off if no washer fluid comes out. The pump may get damaged.

The wiper motor may stop motor operation temporarily to prevent an overload. Wiper operation will return to normal within a few minutes, once the circuit has returned to normal.

#### Models with intermittent time adjustment ring

If the vehicle speeds up while the wipers are operating intermittently, the length of the wipe interval shortens.

When the vehicle speeds up, the wiper operation's shortest delay setting and the LO setting become the same.

#### NOTICE

In cold weather, the blades may freeze to the windscreen.

Operating the wipers in this condition may damage the wipers. Use the demister to warm the windscreen, then turn the wipers on.

\*1: Models with the keyless access system have an **ENGINE START/STOP** button instead of an ignition switch.

\*2: Models with manual intermittent operation

\*3: Models with automatic intermittent operation

\* Not available on all models

Continued

## ■ Automatic Intermittent Wipers \*

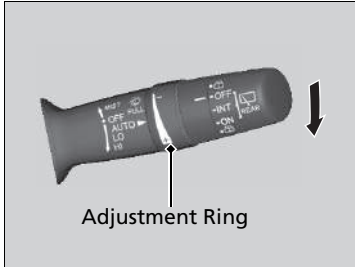

When you push the lever down to **AUTO**, the windscreen wipers sweep once, and go into the automatic mode.

The wipers operate intermittently, at low speed, or at high speed and stops in accordance with the amount of rainfall the rainfall sensor detects.

### ■ AUTO sensitivity adjustment

When the wiper function is set to **AUTO**, you can adjust the sensitivity of the rainfall sensor (using the adjustment ring) so that wipers will operate in accordance with your preference.

#### Sensor sensitivity

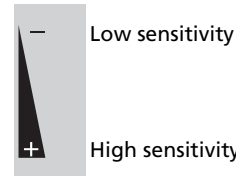

## ☒ Wipers and Washers

If the wipers stop operating due to an obstacle such as the build-up of snow, park the vehicle in a safe place. Rotate the wiper switch to **OFF**, and turn the ignition switch to ACCESSORY [1] or LOCK [0]\*1, then remove the obstacle.

## ☒ Automatic Intermittent Wipers \*

The rainfall sensor is in the location shown below.

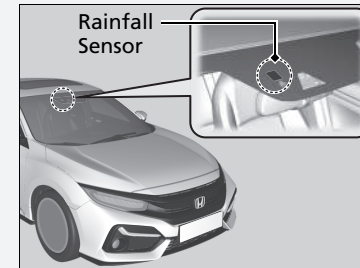

### NOTICE

**AUTO** should always be turned **OFF** before the following situations in order to prevent severe damage to the wiper system:

- Cleaning the windscreen
- Driving through a car wash
- No rain present

## ■ Rear Wiper/Washer\*



- 1 INT: Intermittent
- 2 ON: Continuous wipe
- 3 OFF
- 4 Washer

The rear wiper and washer can be used when the ignition switch is in ON \*1.

### ■ Wiper switch (OFF, INT, ON)

Change the wiper switch setting according to the amount of rain.

### ■ Washer

Sprays on the rear window while you rotate the switch to this position. Hold it to activate the rear wiper and to spray the washer. Once released, the washer spray will stop and the rear wiper will return to its selected switch setting after a few sweeps.

### ■ Operating in reverse

When you put the transmission into  with the windscreen wipers activated, the rear wiper operates automatically as follows even if its switch is off.

Windscreen Wiper Operation	Rear Wiper Operation
Intermittent	Intermittent
Low speed wipe	Continuous
High speed wipe	

\*1: Models with the keyless access system have an **ENGINE START/STOP** button instead of an ignition switch.

\* Not available on all models

*Continued*

### ■ Headlight Washers\*

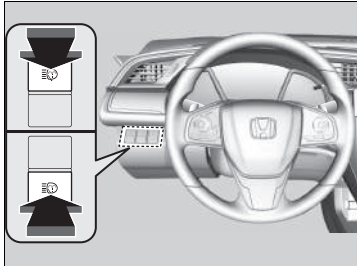

Turn the headlights on and press the headlight washer button to operate. The headlight washers also operate when you turn the windscreen washers for the first time after the ignition switch is in ON \*1.

### ▣ Headlight Washers\*

The headlight washers use the same fluid reservoir as the windscreen washers.

\* 1: Models with the keyless access system have an **ENGINE START/STOP** button instead of an ignition switch.

## Brightness Control

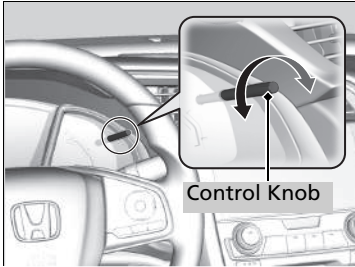

When the brightness of the meter will be reduced, you can use the brightness control knob to adjust instrument panel brightness.

**Brighten:** Turn the knob to the right.

**Dim:** Turn the knob to the left.

Several seconds after adjusting the brightness, you will be returned to the previous display.

### ■ Brightness level indicator

The brightness level is shown on the display while you are adjusting it.

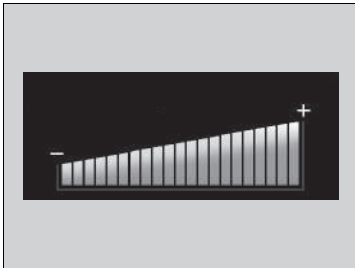

### ▶▶ Brightness Control

By default, the instrument panel switches to night-time mode when the headlights are automatically engaged. You can delay the timing of night-time mode activation when the headlight switch is in **AUTO**.

▶ **Customized Features\*** P. 171, 396

The brightness of the instrument panel will be reduced when the following conditions:

- The ignition switch is in ON (II)<sup>\*1</sup>.
- The light switch is in any position other than **OFF** and it is dark outside.

To cancel the reduced instrument panel brightness when the exterior lights are on, turn the knob to the right until the brightness display is up to max.

The brightness can be set differently for when the exterior lights are on, and when they are off.

\*1: Models with the keyless access system have an **ENGINE START/STOP** button instead of an ignition switch.

\* Not available on all models

## Rear Demister/Heated Door Mirror\* Button

Press the rear demister and heated door mirror button to demist the rear window and mirrors when the ignition switch is in ON <sup>\*1</sup>.

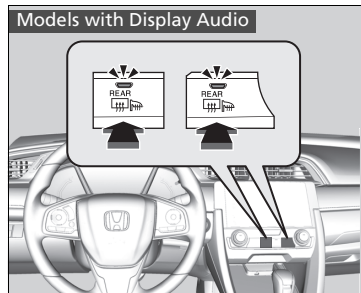
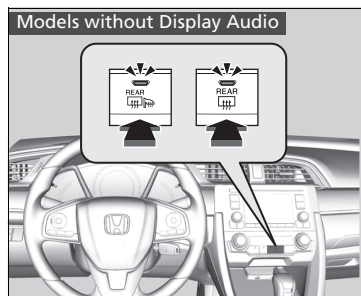

The rear demister and heated door mirrors automatically switch off after 10-30 minutes depending on the outside temperature. However, if the outside temperature is 0°C or below, they do not automatically switch off.

### Rear Demister/Heated Door Mirror\* Button

This system consumes a lot of power, so turn it off when the window has been demisted. Also, do not use the system for a long time while the engine is idling. This may weaken the battery, making it difficult to start the engine.

When the ignition switch is turned to ON <sup>\*1</sup> and the outside temperature is below 5°C, the heated door mirror may automatically activate for 10 minutes.

\*1: Models with the keyless access system have an **ENGINE START/STOP** button instead of an ignition switch.

## Adjusting the Steering Wheel

The steering wheel height and distance from your body can be adjusted so that you can comfortably grip the steering wheel in an appropriate driving posture.

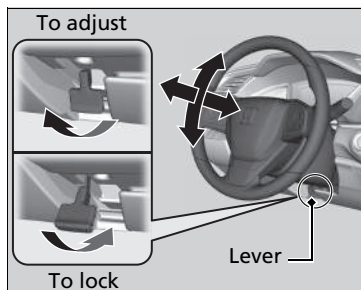

1. Pull the steering wheel adjustment lever up.
  - ▶ The steering wheel adjustment lever is under the steering column.
2. Move the steering wheel up or down, and in or out.
  - ▶ Make sure you can see the instrument panel gauges and indicators.
3. Push the steering wheel adjustment lever down to lock the steering wheel in position.
  - ▶ After adjusting the position, make sure you have securely locked the steering wheel in place by trying to move it up, down, in, and out.

### Adjusting the Steering Wheel

#### **⚠ WARNING**

Adjusting the steering wheel position while driving may cause you to lose control of the vehicle and be seriously injured in a crash.

Adjust the steering wheel only when the vehicle is stopped.

# Adjusting the Mirrors

## Interior Rearview Mirror

Adjust the angle of the rearview mirror when you are sitting in the correct driving position.

### Rearview Mirror with Day and Night Positions\*

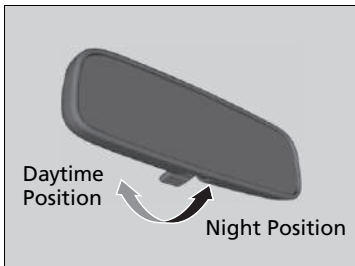

Flip the tab to switch the position. The night position will help to reduce the glare from headlights behind you when driving after dark.

### Automatic Dimming Rearview Mirror\*

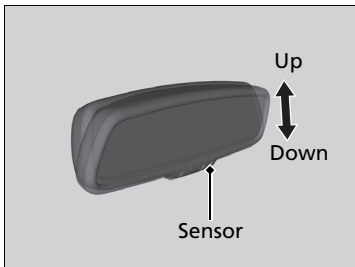

When you are driving after dark, the automatic dimming rearview mirror reduces the glare from headlights behind you, based on inputs from the mirror sensor. This feature is always active.

### Adjusting the Mirrors

Keep the inside and outside mirrors clean and adjusted for best visibility.

Adjust the mirrors before you start driving.

➤ **Front Seats** P. 243

### Automatic Dimming Rearview Mirror\*

The auto dimming function cancels when the transmission is in **[R]**.



## Power Door Mirrors

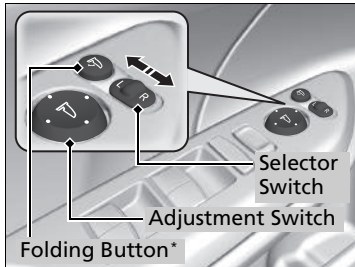

You can adjust the door mirrors when the ignition switch is in ON <sup>\*1</sup>.

### ■ Mirror position adjustment

**L/R selector switch:** Select the left or right mirror. After adjusting the mirror, return the switch to the centre position.

**Mirror position adjustment switch:** Press the switch left, right, up, or down to move the mirror.

### ■ Folding door mirrors\*

Press the folding button to fold in and out the door mirrors.

\*1: Models with the keyless access system have an **ENGINE START/STOP** button instead of an ignition switch.

\* Not available on all models

*Continued*

## ■ Automatic Folding Door Mirror Function \*

### ■ Folding in the door mirrors

Press the lock button on the remote transmitter or press the door lock button\* on either front door or the hatch twice within 10 seconds, and hold it.

- ▶ You can release the button once the mirrors start folding in automatically.

### ■ Folding out the door mirrors

Unlock the driver's door using the remote transmitter or keyless access system\*. Open the driver's door.

- ▶ The mirrors start folding out automatically.

## ⊗ Automatic Folding Door Mirror Function \*

You cannot turn the automatic folding out automatically if they have been folded in using the folding button.

You can turn the automatic folding door mirror function on and off.

⊗ **Customized Features** P. 396

Door mirrors will not fold automatically when locking from inside the vehicle using lock tab or master door lock switch.

# Adjusting the Seats

## Front Seats

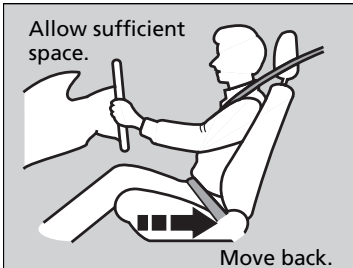

Adjust the driver's seat as far back as possible while allowing you to maintain full control of the vehicle. You should be able to sit upright, well back in the seat and be able to adequately press the pedals without leaning forward, and grip the steering wheel comfortably. The passenger's seat should be adjusted in a similar manner, so that it is as far back from the front airbag in the dashboard as possible.

### ■ Adjusting the Seat Positions

#### ■ Adjusting the front power seat\*

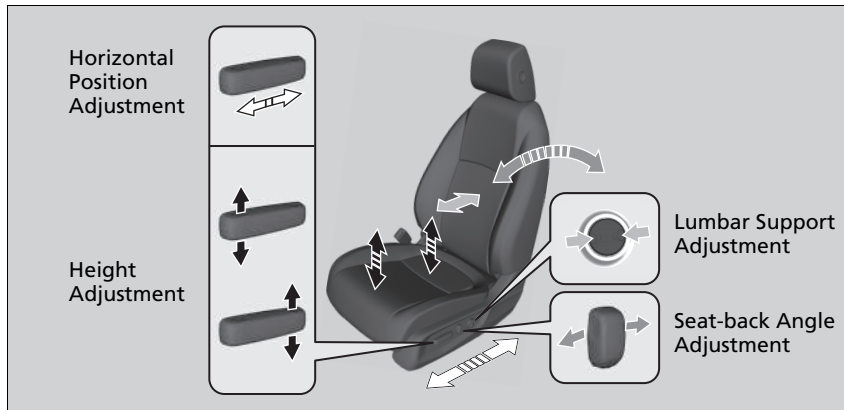

\* Not available on all models

### ▶ Adjusting the Seats

## ⚠ WARNING

Sitting too close to a front airbag can result in serious injury or death if the front airbags inflate.

Always sit as far back from the front airbags as possible while maintaining control of the vehicle.

In addition to the seat adjustment, you can adjust the steering wheel up and down, in and out. Allow at least 25 cm (10 inches) between the centre of the steering wheel and the chest.

Always make seat adjustments before driving.

■ Adjusting the front manual seat(s)\*

**Height Adjustment**

(Driver's seat only)

Pull up or push down the lever to raise or lower the seat.

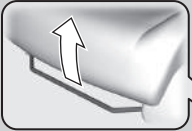

**Horizontal Position Adjustment**

Pull up on the bar to move the seat, then release the bar.

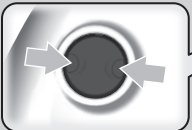

**Lumbar Support Adjustment\***

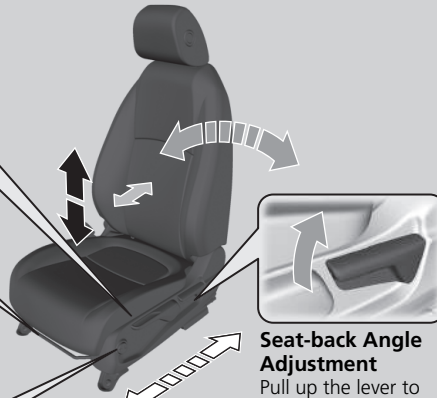

Driver's seat is shown.

**Seat-back Angle Adjustment**

Pull up the lever to change the angle.



▣ Adjusting the front manual seat(s)\*

Once a seat is adjusted correctly, rock it back and forth to make sure it is locked in position.

## ■ Adjusting the Seat-Backs

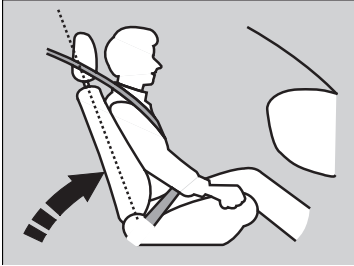

Adjust the driver's seat-back to a comfortable, upright position, leaving ample space between your chest and the airbag cover in the centre of the steering wheel.

The front seat passenger should also adjust their seat-back to a comfortable, upright position.

Reclining a seat-back so that the shoulder part of the belt no longer rests against the occupant's chest reduces the protective capability of the belt. It also increases the chance of sliding under the belt in a crash and being seriously injured. The farther a seat-back is reclined, the greater the risk of injury.

## ▣ Adjusting the Seat-Backs

### **⚠ WARNING**

**Reclining the seat-back too far can result in serious injury or death in a crash.**

**Adjust the seat-back to an upright position, and sit well back in the seat.**

Do not put a cushion, or other object, between the seat-back and your back.

Doing so may interfere with proper seat belt or airbag operation.

If you cannot get far enough away from the steering wheel and still reach the controls, we recommend that you investigate whether some type of adaptive equipment may help.

## Head Restraints

Your vehicle is equipped with head restraints in all seating positions.

Except 2.0 L engine models

### Adjusting the Front Head Restraints Positions

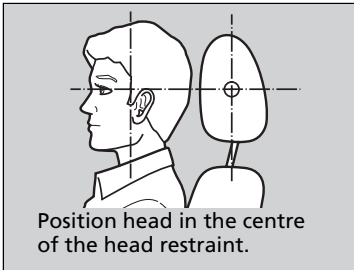

Front head restraints are most effective for protection against whiplash and other rear-impact crash injuries when the centre of the back of the occupant's head rests against the centre of the restraint. The tops of the occupant's ears should be level with the centre height of the restraint.

Head Restraints

Except 2.0 L engine models

### **⚠ WARNING**

Improperly positioning head restraints reduces their effectiveness and increases the likelihood of serious injury in a crash.

**Make sure head restraints are in place and positioned properly before driving.**

In order for the head restraint system to work properly:

- Do not hang any items on the head restraints, or from the restraint legs.
- Do not place any objects between an occupant and the seat-back.
- Install each restraint in its proper location.

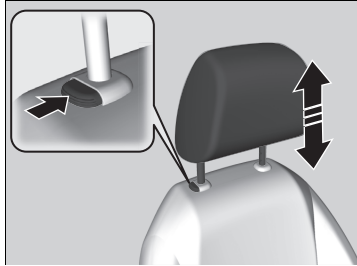

**To raise the head restraint:**

Pull it upward.

**To lower the head restraint:**

Push it down while pressing the release button.

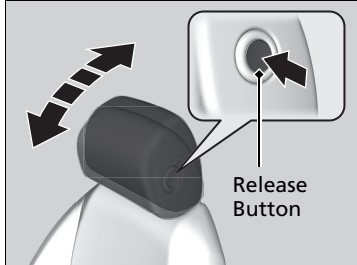

**To tilt the head restraint forward:**

Push the back of it forward.

**To tilt the head restraint backward:**

Push it backward while pressing the release button on the side of the head restraint.

Except 2.0 L engine models

### ■ Changing the Rear Outer Seat Head Restraint Positions

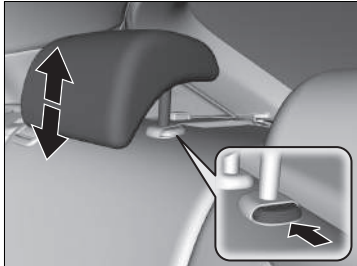

A passenger sitting in a outer back seating position should adjust the height of their head restraint to an appropriate position before the vehicle begins moving.

**To raise the head restraint:**

Pull it upward.

**To lower the head restraint:**

Push it down while pressing the release button.

Except 2.0 L engine models

### ■ Removing and Reinstalling the Front and Rear Outer Head Restraints

Front and rear outer head restraints can be removed for cleaning or repair.

**To remove a head restraint:**

Pull the restraint up as far as it will go. Then push the release button, and pull the restraint up and out.

**To reinstall a head restraint:**

Insert the legs back in place, then adjust the head restraint to an appropriate height while pressing the release button. Pull up on the restraint to make sure it is locked in position.

### ⊗ Changing the Rear Outer Seat Head Restraint Positions

When you use the head restraints in the rear outer seating positions, pull up the head restraints to its highest position. Do not use it in any lower position.

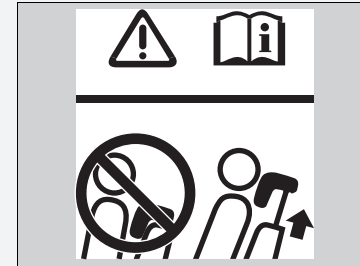

### ⊗ Removing and Reinstalling the Front and Rear Outer Head Restraints

## ⚠ WARNING

Failure to reinstall, or correctly reinstall, the head restraints can result in severe injury during a crash.

Always replace the head restraints before driving.



## Maintain a Proper Sitting Position

After all occupants have adjusted their seats and head restraints\*, and put on their seat belts, it is very important that they continue to sit upright, well back in their seats, with their feet on the floor until the vehicle is safely parked and the engine is off.

Sitting improperly can increase the chance of injury during a crash. For example, if an occupant slouches, lies down, turns sideways, sits forward, leans forward or sideways, or puts one or both feet up, the chance of injury during a crash is greatly increased.

In addition, an occupant who is out of position in the front seat can be seriously or fatally injured in a crash by striking interior parts of the vehicle or being struck by an inflating front airbag.

### ► Maintain a Proper Sitting Position

#### **⚠ WARNING**

Sitting improperly or out of position can result in serious injury or death in a crash.

Always sit upright, well back in the seat, with your feet on the floor.

\* Not available on all models

## Rear Seats

### Folding Down the Rear Seats

Separately fold down the left and right halves of the rear seat to make room for luggage.

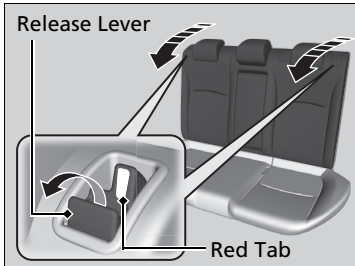

1. Lower the head restraints\* to their lowest position.
2. Pull the release lever and fold down the seat-back.

### Folding Down the Rear Seats

The rear seat-back(s) can be folded down to accommodate bulkier items in the luggage area.

To lock a seat-back upright, push it backwards until it locks, so that the red tabs in the release lever go down.

When returning the seat-back to its original position, push it firmly back.

**Make sure all items in the luggage area or items extending to the rear seats are properly secured. Loose items can fly forward if you have to brake hard.**

The front seat(s) must be far enough forward so they do not interfere with the rear seats as they fold down.

## Armrest

### ■ Using the Front Seat Armrest



The console lid can be used as an armrest.

**To adjust:**

Slide the armrest to desired position.

### ■ Using the Rear Seat Armrest\*

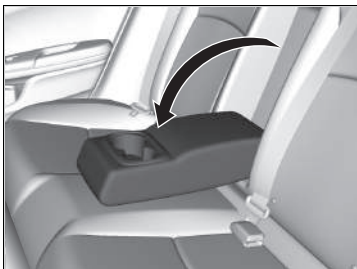

Pull down the armrest in the centre backrest.

\* Not available on all models

# Interior Lights/Interior Convenience Items

## Interior Lights

### Interior Light Switches

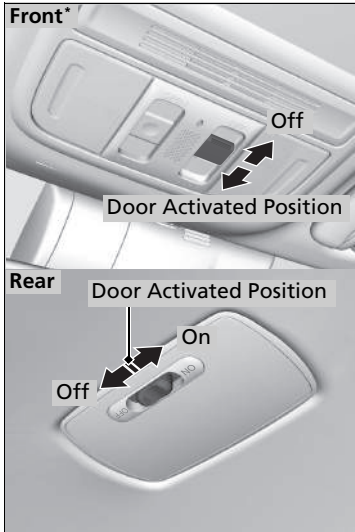

#### ■ ON

The interior lights come on regardless of whether the doors are open or closed.

#### ■ Door activated

The interior lights come on in the following situations:

- When any of the doors are opened.
- You unlock the driver's door.

#### Models without keyless access system

- You remove the key from the ignition switch.

#### Models with keyless access system

- When the power mode is set to VEHICLE OFF (LOCK).

#### ■ OFF

The interior lights remain off regardless of whether the doors are open or closed.

### Interior Light Switches

In the door activated position, the interior lights fade out and go off about 30 seconds after the doors are closed.

The lights go off after about 30 seconds in the following situations:

- When you unlock the driver's door but do not open it.

#### Models without keyless access system

- When you remove the key from the ignition switch but do not open a door.

#### Models with keyless access system

- When you set the power mode to VEHICLE OFF (LOCK) but do not open a door.

You can change the interior lights dimming time.

➤ **Customized Features\*** P. 171, 396

The interior lights go off immediately in the following situations:

- When you lock the driver's door.

#### Models without keyless access system

- When you close the driver's door with the key in the ignition switch.
- When you turn the ignition switch to ON **II**.

#### Models with keyless access system

- When you close the driver's door in ACCESSORY mode.
- When you set the power mode to ON.

To avoid draining the battery, do not leave the interior light on for an extended length of time when the engine is off.

## ■ Map Lights

Models without ambient light

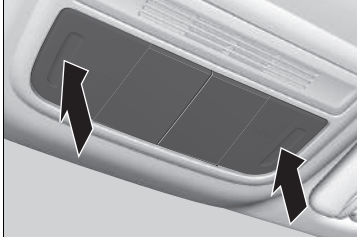

Models with ambient light

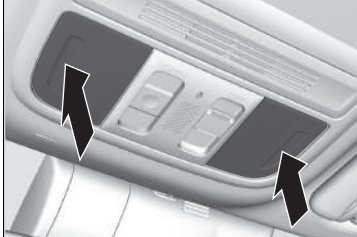

The map lights can be turned on and off by pressing the lenses.

## ▣ Interior Light Switches

If you leave any of the doors open in VEHICLE OFF (LOCK) mode, or without the key in the ignition switch, the interior lights go off after about 15 minutes.

## ▣ Map Lights

When the front interior light switch\* is in the door activated position and any door is open, the map light will not go off when you press the lens.

\* Not available on all models

## Interior Convenience Items

### Glove Box

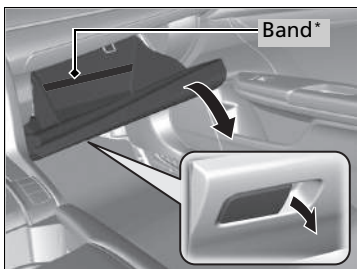

Pull the handle to open the glove box.

### Glove Box

#### **⚠ WARNING**

An open glove box can cause serious injury to your passenger in a crash, even if the passenger is wearing the seat belt.

Always keep the glove box closed while driving.

**■ Console Compartment**

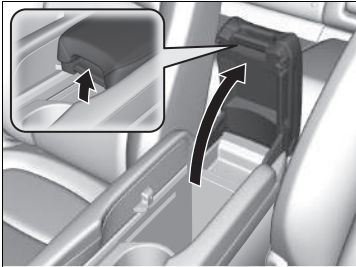

Your vehicle has a multi-function centre console. It includes a storage compartment and an armrest. Slide the armrest to the rearmost position. Pull up on the handle to open the console compartment.

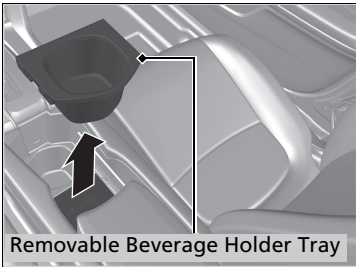

Removable Beverage Holder Tray

**Right-hand drive type**

You can create more storage space by removing the removable beverage holder tray.

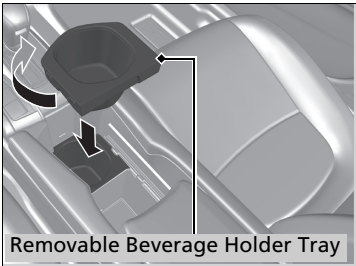

Removable Beverage Holder Tray

If you want to make greater use of the console box:

1. Raise the removable beverage holder tray and reverse its orientation.
2. Put the removable beverage holder on the beverage holder which is in front.

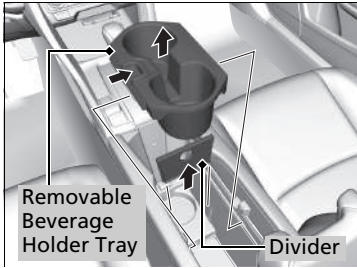

**Left-hand drive type**

You can create more storage space by removing the removable beverage holder tray and a divider.



## ■ Beverage Holders

Right-hand drive type

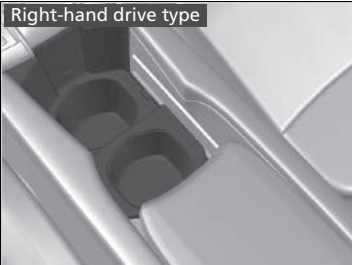

Left-hand drive type

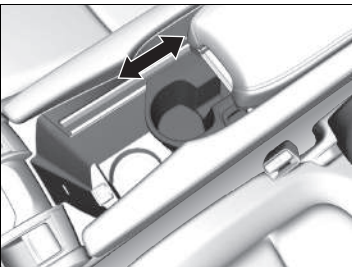
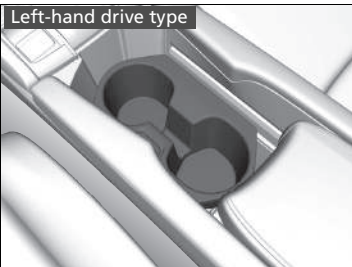

### ■ Front seat beverage holders

Are located in the console between the front seats.

- Move the armrest rearward to use the beverage holders.

Left-hand drive type

#### To place a short beverage container:

Move the removable beverage holder tray forward.

**To place a tall beverage container:** Move the removable beverage holder tray rearward.

## ▣ Beverage Holders

### NOTICE

Spilled liquids damage the upholstery, carpeting, and electrical components in the interior.

Be careful when you are using the beverage holders. Hot liquid can scald you.

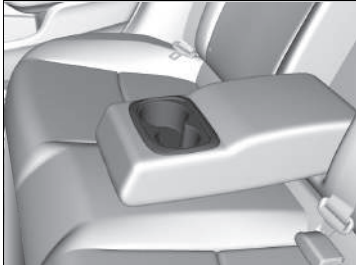

■ **Rear seat beverage holders\***

Fold the armrest down to use the rear seat beverage holders.

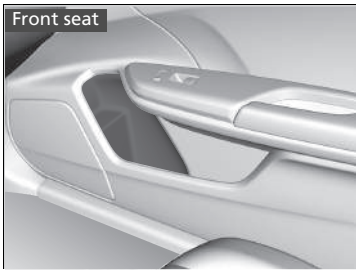

Front seat

■ **Door beverage holders**



Rear seat

## ■ Accessory Power Socket

The accessory power socket can be used when the ignition switch is in ACCESSORY **I** or ON **II**\*1.

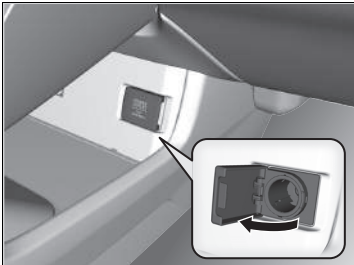

### ■ Accessory power socket (console panel)

Open the cover to use it.

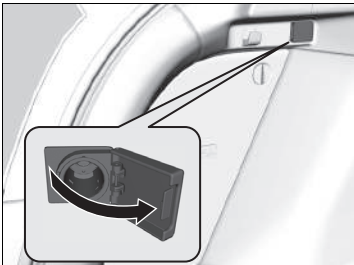

### ■ Accessory power socket (luggage area)\*

Open the cover to use it.

## ▣ Accessory Power Socket

### NOTICE

Do not insert an automotive type cigarette lighter element. This can overheat the power socket.

The accessory power socket is designed to supply power for 12-volt DC accessories that are rated 180 watts (15 amps) or less.

To prevent battery drain, only use the power socket with the engine running.

\*1: Models with the keyless access system have an **ENGINE START/STOP** button instead of an ignition switch.

\* Not available on all models

## Wireless Charger\*

To use the wireless charger, the power mode must be in ACCESSORY or ON. Charge a compatible device on the area indicated by the  mark as follows:

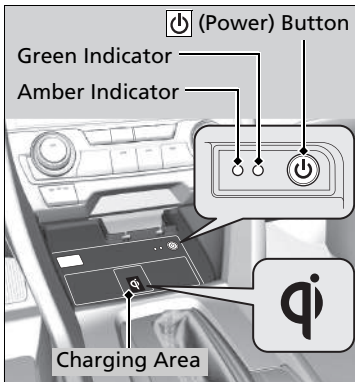

1. To turn the system on and off, press and hold the  (power) button.
  - When the system is activated, the green indicator light comes on.
2. Place the device you want to charge on the charging area.
  - The system will automatically start charging the device, and the amber indicator light will come on.
  - Make sure that the device is compatible with the system, and placed with the chargeable side in the centre of the charging area.
3. When charging is completed, the green indicator light will come on.
  - Depending on the device, the amber indicator light will stay on.

## Wireless Charger\*

### WARNING

Metal objects between the charge pad and the device to be charged will get hot and can burn you.

- Always remove foreign objects from the charge pad before charging the device.
- Be sure the surface is clear of dust and other debris before charging.
- Do not spill liquids (i. e. water, drinks, etc.) on the charger and the device.
- Do not use oil, grease, alcohol, benzene or thinner for cleaning the charge pad.
- Do not cover the system with towels, clothing, or other objects while charging etc.
- Avoid spraying aerosols which may come in contact with the charge pad surface.

This system consumes a lot of power. Do not use the system for a long time when the engine is not running. This may weaken the battery, making it difficult to start the engine.

When using the wireless charger, check the user's manual that came with the compatible device you want to charge.

■ **When charging does not start**

Perform one of the solutions in the following table.

Indicator		Cause	Solution
Green & Amber	Blinking simultaneously	There is an obstacle(s) between the charging area and the device.	Remove the obstacle(s).
		The device is not within the charging area.	Move the device to the centre of the charging area where  is located.
Amber	Blinking	The wireless charger is faulty.	Contact a dealer for repairs.

► Wireless Charger\*

**NOTICE**

Do not place any magnetic recording media or precision machines within the charging area while charging. The data on your cards such as credit cards can be lost because of the magnetic effect. Also precision machines such as watches can go wrong.

“Qi” and  marks are the registered trademarks owned by Wireless Power Consortium (WPC).

In the following cases, charging may stop or not start:

- The device is already fully charged.
- The temperature of the device is extremely high while charging.
- You are at a place that emits strong electromagnetic waves or noises, such as TV station, electric power plant, or petrol station.

A device may not charge if the size or shape of its chargeable side is not appropriate for use with the charging area.

Not all devices are compatible with the system.

During the charging phase, it is normal for the charging area and device to heat up.

\* Not available on all models

Continued

Wireless Charger\*

Charging may be briefly interrupted when:

- All the doors and the hatch are closed
  - to avoid interference with the proper functioning of the keyless access system.
- The position of the device is altered.

Do not charge more than one device at a time on a charging area.

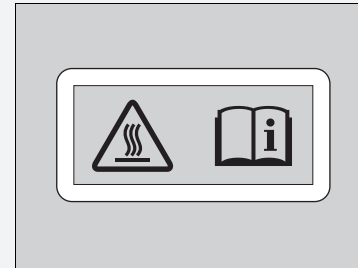

Burn risk:

Any metal objects placed between pad and device may become hot.

## ■ Coat Hooks

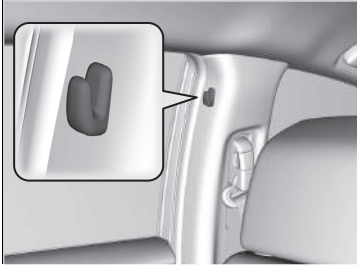

There are coat hooks on the left and right door pillars.

## ▣ Coat Hooks

The coat hook is not designed for large or heavy items.

### ■ Under-Floor Storage Area\*

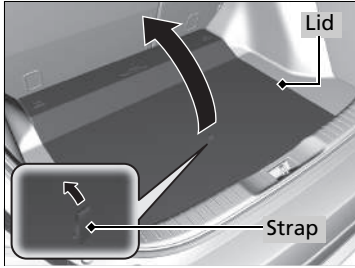

Pull the strap and open the lid.

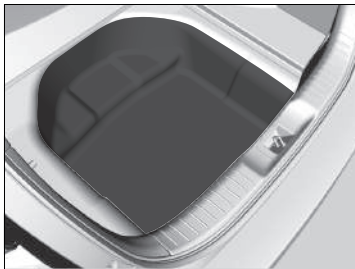

Controls



## ■ Luggage Hook

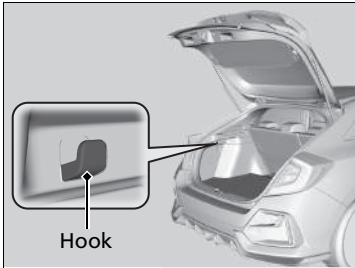

The luggage hook in the luggage area can be used to hang a light items.

## ■ Tie-down Anchors\*

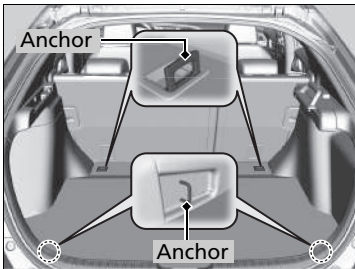

The tie-down anchors on the luggage area floor can be used to install a net for securing items.

## ▣ Luggage Hook

### NOTICE

Do not hang a large object or an object that weighs more than 3 kg (6 lbs) on the luggage hook. Hanging heavy or large objects may damage the hook.

## ▣ Tie-down Anchors\*

Do not let anyone access items in the luggage area while driving. Loose items can cause injury if you have to brake hard.

\* Not available on all models

*Continued*

## Luggage Area Cover\*

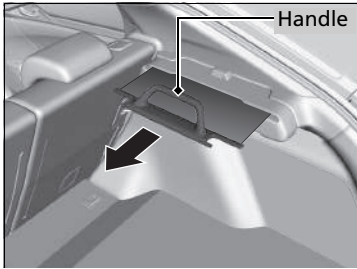

The luggage area cover can be used to conceal your items and protect them from direct sunlight.

### ■ To extend:

Pull the handle fully towards the hook on the other side and let the hook catch hold of the handle.

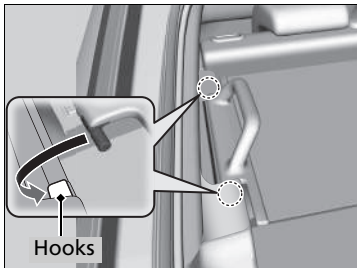

### ■ To retract:

Slip the rods out of the hooks, then slowly roll it back until it is completely retracted.

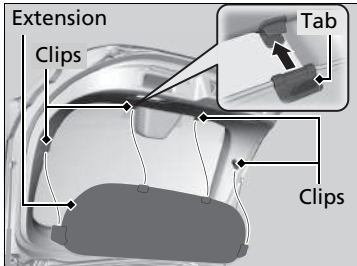

### ■ Luggage area cover extension

The extension is attached at the back of the hatch by four clips. It extends the covering area when you close the hatch. To remove, unclip the extension from the hatch. When reinstalling the extension, make sure that the tabs come to the near side.

## ☒ Luggage Area Cover\*

Do not access parcels in the luggage area while driving.

This may cause injury if you have to brake hard.

Do not stack objects higher than the top of the seat in the luggage area. They could block your view and be thrown about the vehicle during a sudden stop.

To prevent luggage area cover damage:

- Do not place items on the luggage area cover.
- Do not put weight on the luggage area cover.

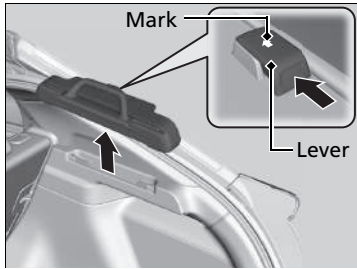

■ **To remove:**

Push and hold the lever in the direction of the arrow mark on the housing and lift the housing out of its position.

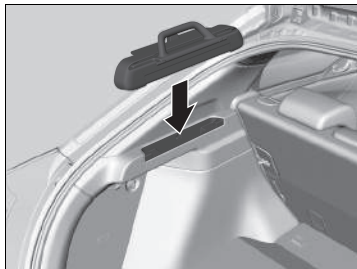

The housing can be installed on either side of the luggage area.

## Front Seat Heaters\*



The ignition switch must be in ON \*1 to use the seat heaters.

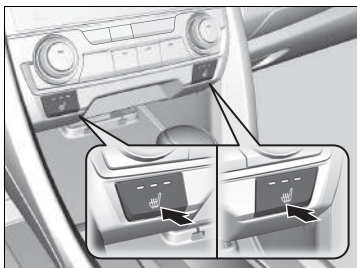

Press the seat heater button:

- Once - The HI setting (three indicators on)
- Twice - The MID setting (two indicators on)
- Three times - The LO setting (one indicator on)
- Four times - The OFF setting (no indicators on)

\* 1: Models with the keyless access system have an **ENGINE START/STOP** button instead of an ignition switch.

\* Not available on all models

## Front Seat Heaters\*

### **WARNING**

Heat induced burns are possible when using seat heaters.

Persons with a diminished ability to sense temperature (e.g., persons with diabetes, lower-limb nerve damage, or paralysis) or with sensitive skin should not use seat heaters.

Do not use the seat heaters even in LO when the engine is off. Under such conditions, the battery may be weakened, making the engine difficult to start.

## ■ Rear Seat Heaters\*

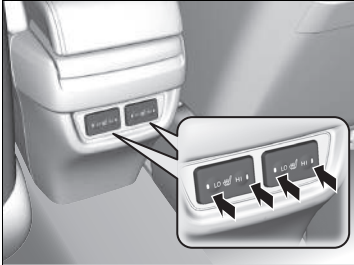

The power mode must be in ON to use the seat heaters.

There is no heater in the rear centre seating position.

The indicator for your setting comes on while the seat heater is in use. Press the switch on the opposite side to turn the heater off. The indicator goes off.

## ▣ Rear Seat Heaters\*

### **⚠ WARNING**

Heat induced burns are possible when using seat heaters.

Persons with a diminished ability to sense temperature (e.g., persons with diabetes, lower-limb nerve damage, or paralysis) or with sensitive skin should not use seat heaters.

Do not use the seat heaters even in **LO** when the engine is off. Under such conditions, the battery may be weakened, making the engine difficult to start.

In the **LO** setting, the heater runs continuously and does not automatically turn off.

\* Not available on all models

# Heating System\*

## Using Automatic Heating

The automatic heating system maintains the interior temperature you select. The system also selects the proper mix of heated or outside air that raises or lowers the interior temperature to your preference.

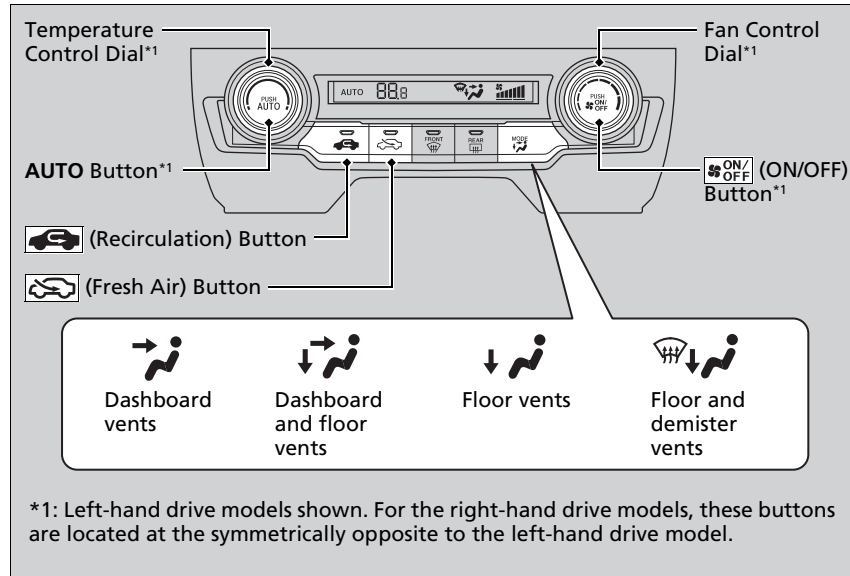

Use the system when the engine is running.

1. Press the **AUTO** button.
2. Adjust the interior temperature using the temperature control dial.
3. Press the **ON/OFF** button to cancel.

### Using Automatic Heating

If any buttons are pressed while using the heating system in auto, the function of the button that was pressed will take priority.

The **AUTO** indicator will go off, but functions unrelated to the button that was pressed will be controlled automatically.

During idle-stops, heating system is suspended, and only the blower remains active. If you do not want heating system suspended, press the Auto Idle Stop **OFF** button to cancel idle-stop.

To prevent cold air from blowing in from outside, the fan may not start immediately when the **AUTO** button is pressed.



When you set the temperature to the lower or upper limit, **Lo** or **Hi** is displayed.

Pressing the **ON/OFF** button switches the heating system between on and off. When turned on, the system returns to your last selection.

### Models with ECON button

While ECON mode is active, the heating system may have reduced heating performance.

### ■ Switching between the recirculation and fresh air modes

Press the  (recirculation) or  (fresh air) button to switch the mode depending on environmental conditions.

 Recirculation mode (indicator on): Recirculates air from the vehicle's interior through the system.

 Fresh air mode (indicator on): Maintains outside ventilation. Keep the system in fresh air mode in normal situations.

## Defrosting the Windscreen and Windows

Left-hand drive type

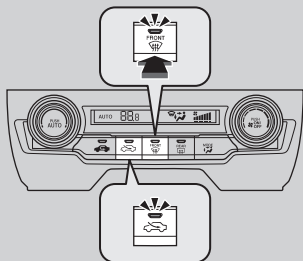

Pressing the  (windscreen demister) button automatically switches the system to fresh air mode.

Press the  button again to turn off, the system returns to the previous settings.

Right-hand drive type

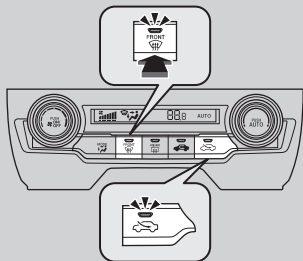

## Defrosting the Windscreen and Windows

**For your safety, make sure you have a clear view through all the windows before driving.**

Do not set the temperature near the upper or lower limit.

When cold air hits the windscreen, the outside of the windscreen may fog up.

If the side windows fog up, adjust the vents so that the air hits the side windows.

### Continuously variable transmission models

If you press the  button during Auto Idle Stop, the engine restarts automatically.

### Manual transmission models

To defog during the Auto Idle Stop, restart the engine as follows.

1. Make sure the shift lever is in **N**.
2. Depress the clutch pedal fully.
3. Press the  button.



■ To rapidly defrost the windows

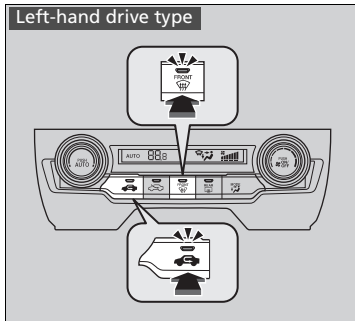

1. Press the  button.
2. Press the  button.

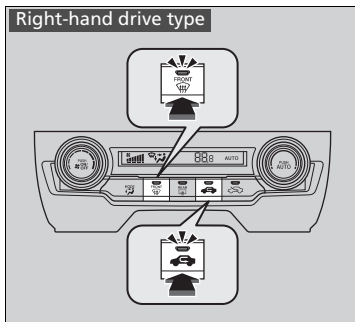

▣ To rapidly defrost the windows

After defrosting the windows, switch over to fresh air mode. If you keep the system in recirculation mode, the windows may fog up from humidity. This impedes visibility.

## Automatic Heating Sensors

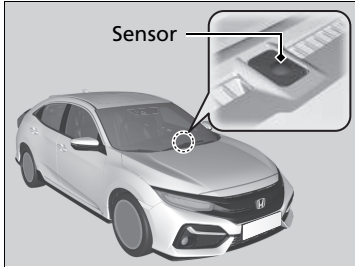

The automatic heating system is equipped with sensors. Do not cover or spill any liquid on them.

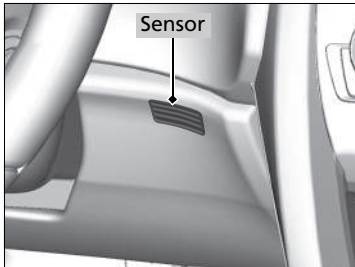

# Climate Control System\*

## Using Automatic Climate Control

The automatic climate control system maintains the interior temperature you select. The system also selects the proper mix of heated or cooled air that raises or lowers the interior temperature to your preference as quickly as possible.

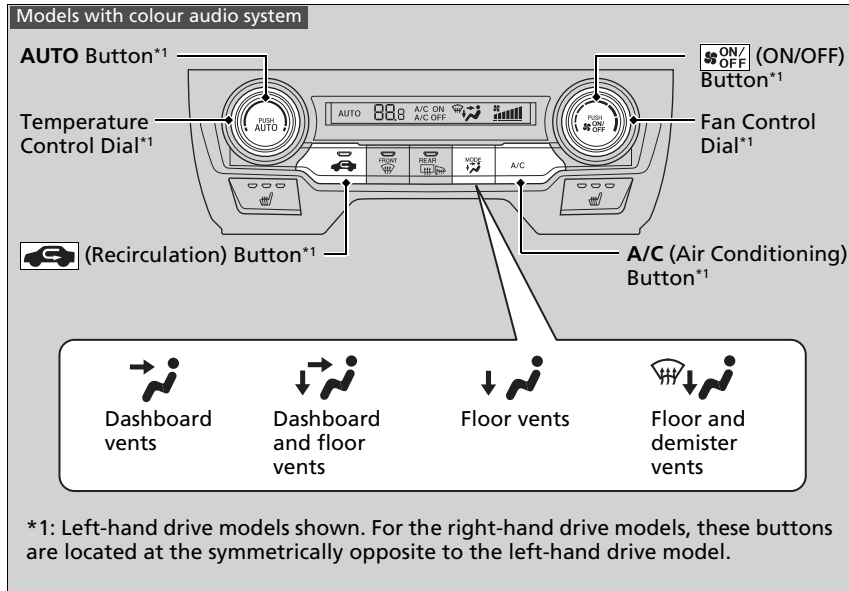

Use the system when the engine is running.

1. Press the **AUTO** button.
2. Adjust the interior temperature using the temperature control dial.
3. Press the **ON/OFF** (ON/OFF) button to cancel.

\* Not available on all models

### Using Automatic Climate Control

If any buttons/icons\* are pressed while using the climate control system in auto, the function of the button/icon\* that was pressed will take priority.

The **AUTO** indicator will go off, but functions unrelated to the button/icon\* that was pressed will be controlled automatically.

### Models with Auto Idle Stop

During idle-stops, air-conditioning is suspended, and only the blower remains active. If you do not want air-conditioning suspended, press the Auto Idle Stop **OFF** button to cancel idle-stop.

### All models

To prevent cold air from blowing in from outside, the fan may not start immediately when the **AUTO** button is pressed.

If the interior is very warm, you can cool it down more rapidly by partially opening the windows, turning the system on auto, and setting the temperature to low. Change the fresh air mode to recirculation mode until the temperature cools down.

When you set the temperature to the lower or upper limit, **Lo** or **Hi** is displayed.

Continued

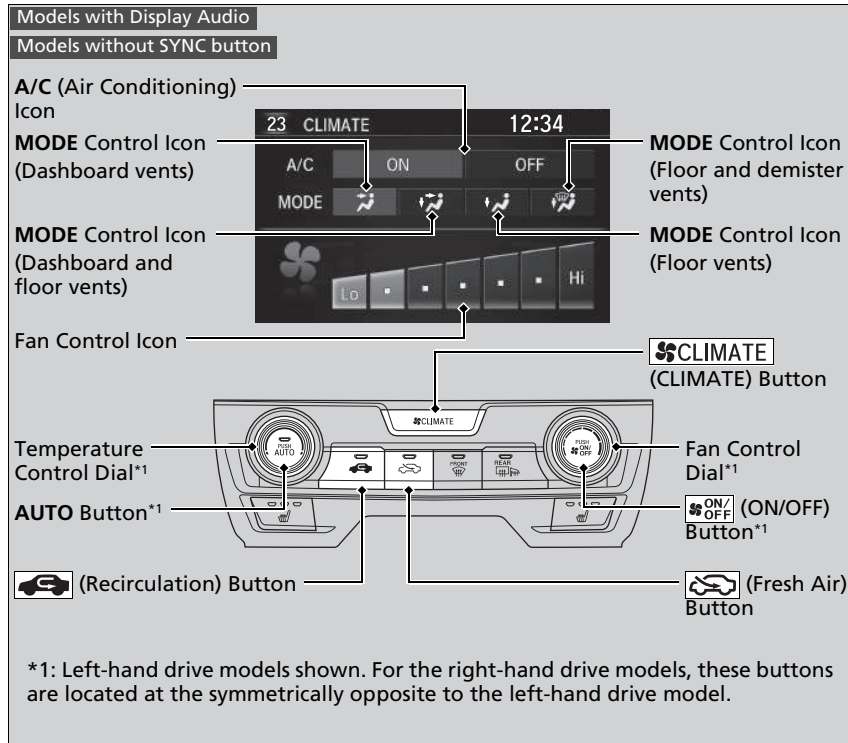

Use the system when the engine is running.

1. Press the **AUTO** button.
2. Adjust the interior temperature using the temperature control dial.
3. Press the **ON/OFF** (ON/OFF) button to cancel.

► Using Automatic Climate Control

Pressing the **ON/OFF** button switches the climate control system between on and off. When turned on, the system returns to your last selection.

**Models with Display Audio**

Press the **CLIMATE** button to display **A/C**, **MODE**, fan control information on the audio/information screen to operate manually. Select icon to turn on or off **A/C**, change the vent mode, or change the fan speed.

**Models with ECON button**

While **ECON** mode is active, the climate control system may have reduced cooling performance.

**Models with Display Audio**  
**Models with SYNC button**

**A/C (Air Conditioning) Icon**

**MODE Control Icon (Dashboard vents)**

**MODE Control Icon (Dashboard and floor vents)**

**Fan Control Icon**

**(Fan Control) Buttons**

**Driver's Side Temperature Control Dial\*<sup>1</sup>**

**AUTO Button\*<sup>1</sup>**

**(ON/OFF) Button\*<sup>1</sup>**

**MODE Control Icon (Floor and demister vents)**

**MODE Control Icon (Floor vents)**

**CLIMATE Button**

**Passenger's Side Temperature Control Dial\*<sup>1</sup>**

**SYNC (Synchronization) Button\*<sup>1</sup>**

**(Recirculation) Button\*<sup>1</sup>**

\*1: Left-hand drive models shown. For the right-hand drive models, these buttons are located at the symmetrically opposite to the left-hand drive model.

Use the system when the engine is running.

1. Press the **AUTO** button.
2. Adjust the interior temperature using the driver's side or passenger's side temperature control dial.
3. Press the **(ON/OFF)** button to cancel.

Continued

### ■ Switching between the recirculation and fresh air modes



#### Models without fresh air button

Press the  (recirculation) button and switch the mode depending on environmental conditions.

Recirculation mode (indicator on): Recirculates air from the vehicle's interior through the system.

Fresh air mode (indicator off): Maintains outside ventilation. Keep the system in fresh air mode in normal situations.

#### Models with fresh air button

Press the  (recirculation) or  (fresh air) button to switch the mode depending on environmental conditions.

 Recirculation mode (indicator on): Recirculates air from the vehicle's interior through the system.

 Fresh air mode (indicator on): Maintains outside ventilation. Keep the system in fresh air mode in normal situations.

## Defrosting the Windscreen and Windows

### Left-hand drive type

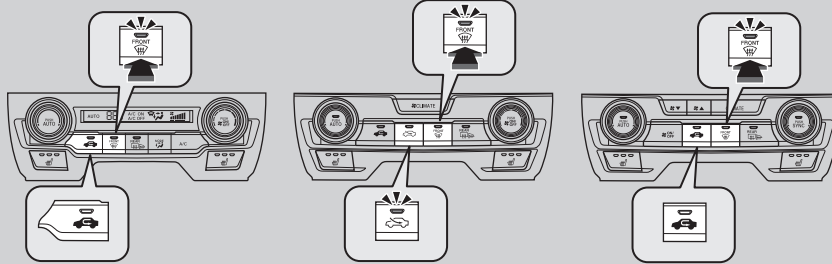

### Right-hand drive type

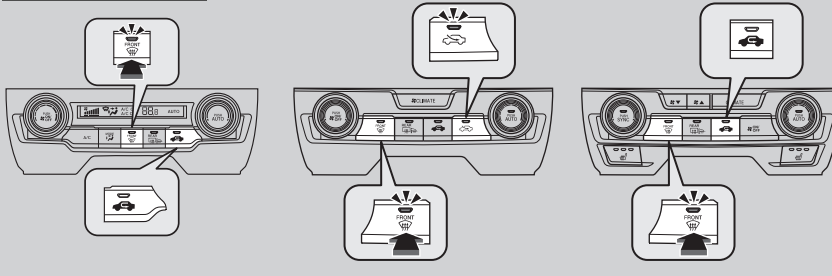

Pressing the  (windscreen demister) button turns the air conditioning system on and automatically switches the system to fresh air mode.

Press the  button again to turn off, the system returns to the previous settings.

### Defrosting the Windscreen and Windows

**For your safety, make sure you have a clear view through all the windows before driving.**

Do not set the temperature near the upper or lower limit.

When cold air hits the windscreen, the outside of the windscreen may fog up.

If the side windows fog up, adjust the vents so that the air hits the side windows.

#### Models with Auto Idle Stop

##### Continuously variable transmission models

If you press the  button during Auto Idle Stop, the engine restarts automatically.

##### Manual transmission models

To defog during the Auto Idle Stop, restart the engine as follows.

1. Make sure the shift lever is in **N**.
2. Depress the clutch pedal fully.
3. Press the  button.

### ■ To rapidly defrost the windows

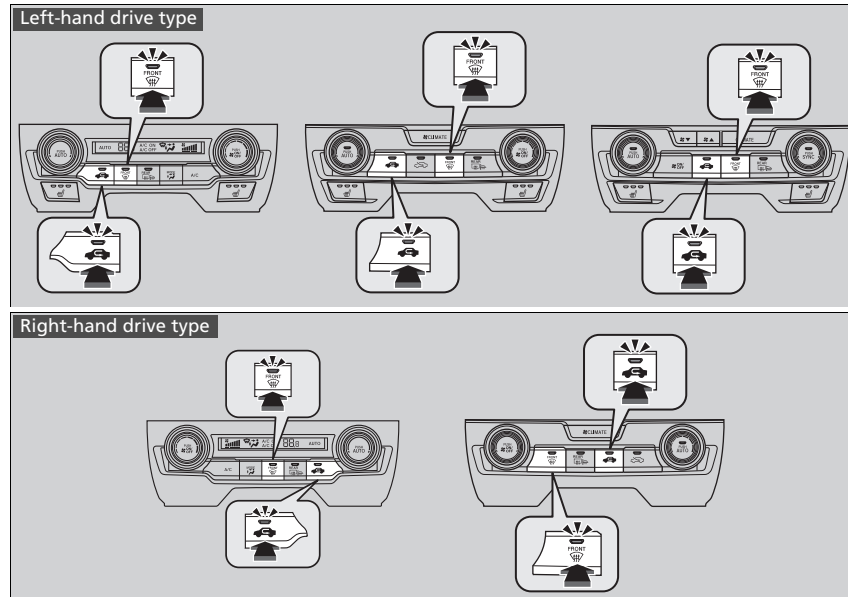

1. Press the  button.
2. Press the  button.

### ☒ To rapidly defrost the windows

After defrosting the windows, switch over to fresh air mode. If you keep the system in recirculation mode, the windows may fog up from humidity. This impedes visibility.



## ■ Synchronization Mode\*

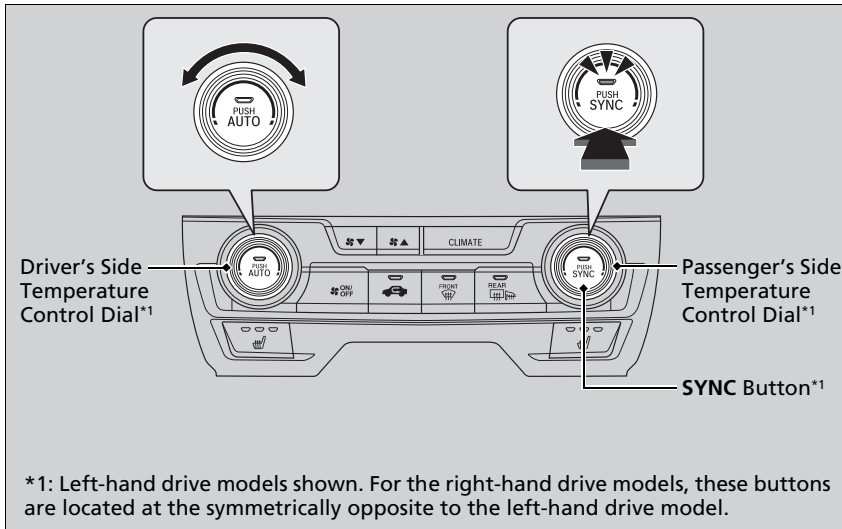

You can set the temperature synchronously for the driver's side and the passenger's side in synchronization mode.

1. Press the **SYNC** button.
  - The system switches to synchronization mode.
2. Adjust the temperature using the driver's side temperature control dial.

Press the **SYNC** button or change the passenger's side temperature setting to return to dual mode.

\* Not available on all models

## ► Synchronization Mode\*

When you press the  button, the system changes to synchronization mode.

When the system is in dual mode, the driver's side temperature and the passenger's side temperature can be set separately.

## Automatic Climate Control Sensors

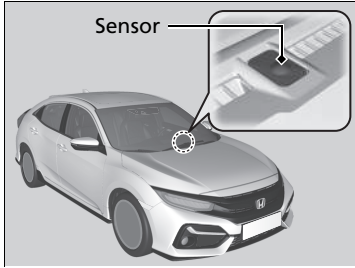

The automatic climate control system is equipped with sensors. Do not cover or spill any liquid on them.

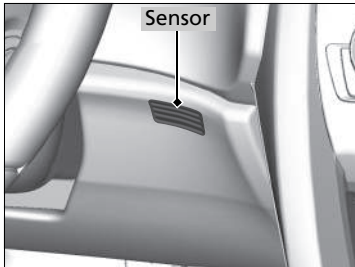

# Features

This chapter describes how to operate the audio system and other technology features.

## Audio System\*

About Your Audio System.....	284
USB Port(s).....	285
HDMI™ Port*.....	287
Audio System Theft Protection.....	287
Audio Remote Controls.....	288

### Models with colour audio system

## Audio System Basic Operation

Audio/Information Screen.....	291
Adjusting the Sound.....	295
Display Setup.....	296
Playing AM/FM Radio.....	297
Playing DAB (Digital Audio Broadcasting)*.....	303

Playing an iPod.....	306
Playing a USB Flash Drive.....	309
Playing <i>Bluetooth</i> ® Audio.....	312

### Models with Display Audio

## Audio System Basic Operation

Audio/Information Screen.....	316
Adjusting the Sound.....	337
Display Setup.....	338
Voice Control Operation*1.....	340
Playing AM/FM Radio.....	344
Playing DAB (Digital Audio Broadcasting)*.....	347
Playing an iPod.....	350
Song By Voice™ (SBV)*.....	353
Playing Aha™*.....	357

Playing a USB Flash Drive.....	358
Playing <i>Bluetooth</i> ® Audio.....	361
Playing a Video Using the HDMI™.....	363
On Board Apps*.....	365
Smartphone Connection.....	366
Wi-Fi Connection.....	370
Siri Eyes Free.....	372
Apple CarPlay.....	373
Android Auto.....	376
<b>Audio Error Messages</b> .....	380

## General Information on the Audio System

<b>Customized Features</b> .....	388, 396
<b>Hands-Free Telephone System</b> .....	430, 451

\* Not available on all models

# Audio System\*

## About Your Audio System

The audio system features AM/FM radio. It can also play USB flash drives, iPod, iPhone, *Bluetooth*® devices, and HDMI™ devices\*.

You can operate the audio system from the buttons and switches on the panel, the remote controls on the steering wheel, or the icons on the touchscreen interface\*.

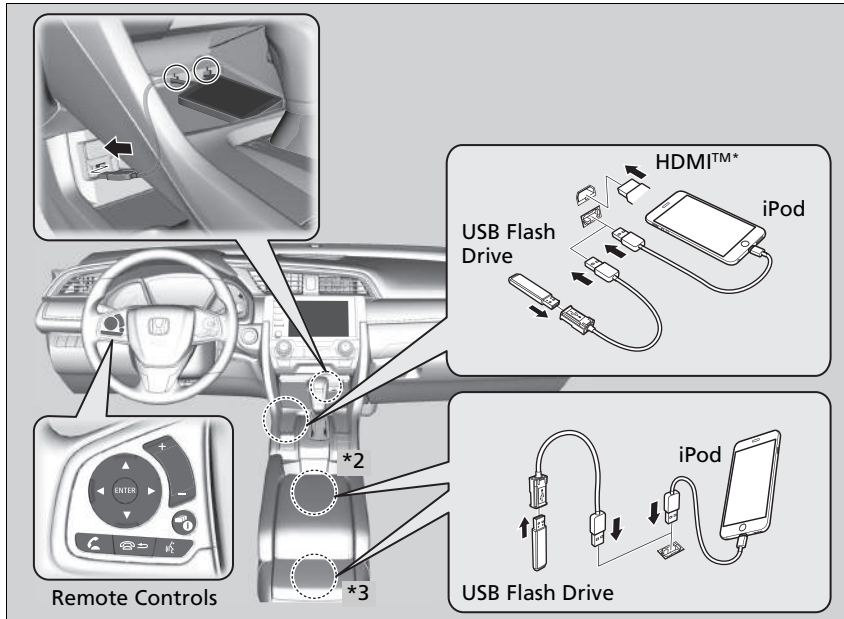

\*2: Left-hand drive type

\*3: Right-hand drive type

\* Not available on all models

### About Your Audio System

iPod, iPhone and iTunes are trademarks of Apple Inc.

#### Key Off Operation\*

After you turn the ignition switch to LOCK [0]<sup>\*1</sup>, you can use the audio system for up to 30 minutes per driving cycle. However, whether you can continue using the audio system depends on the battery condition. Repeatedly using this feature may drain the battery.

\*1: Models with the keyless access system have an **ENGINE START/STOP** button instead of an ignition switch.

## USB Port(s)

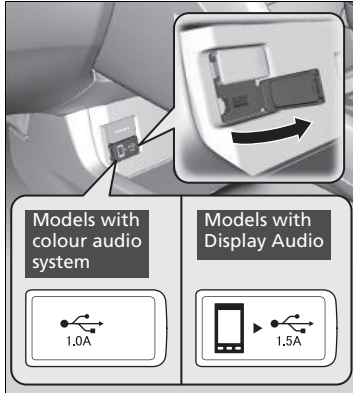

Install the device USB connector or the USB flash drive to the USB port.

### Models with colour audio system

- ▶ The USB port (1.0A) is for playing audio files on a USB flash drive, connecting a mobile phone, and charging device.

### Models with Display Audio

- ▶ The USB port (1.5A) is for charging devices, playing audio files and connecting compatible phones with smartphone connection, Apple CarPlay or Android Auto.
- ▶ To prevent any potential issues, be sure to use an Apple MFi Certified Lightning Connector for Apple CarPlay, and for Android Auto, the USB cables should be certified by USB-IF to be compliant with USB 2.0 Standard.

### USB Port(s)

- Do not leave the iPod or USB flash drive in the vehicle. Direct sunlight and high temperatures may damage it.
- We recommend that you use a USB cable if you are attaching a USB flash drive to the USB port.
- Do not connect the iPod or USB flash drive using a hub.
- Do not use a device such as a card reader or hard disk drive, as the device or your files may be damaged.
- We recommend backing up your data before using the device in your vehicle.
- Displayed messages may vary depending on the device model and software version.

### USB charge

The USB port can supply up to 1.5A of power. It does not output 1.5A unless requested by the device. For amperage details, read the operating manual of the device that needs to be charged.

Under certain conditions, a device connected to the port may generate noise in the radio you are listening to.

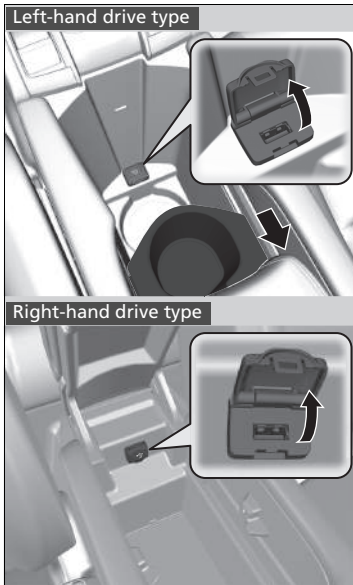

■ **In the console compartment\***

The USB port (1.0A) is for playing audio files on the USB flash drive, connecting a mobile phone, and charging device.

■ **Left-hand drive type**

- ▶ Move the removable beverage holder tray rearward.

## HDMI™ Port\*

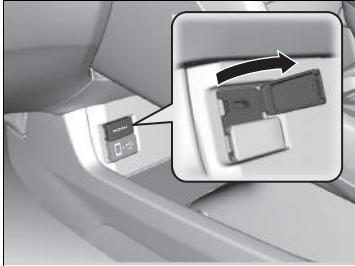

1. Open the cover.
2. Install the HDMI™ cable to the HDMI™ port.

## Audio System Theft Protection

The audio system is disabled when it is disconnected from the power source, such as when the battery is disconnected or goes dead. In certain conditions, the system may display a code entry screen. If this occurs, reactivate the audio system.

### ■ Reactivating the audio system

1. Turn the ignition switch to ON \*1.
2. Turn on the audio system.
3. Press and hold the audio system power button for more than two seconds.
  - ▶ The audio system is reactivated when the audio control unit establishes a connection with the vehicle control unit. If the control unit fails to recognise the audio unit, you must go to a dealer and have the audio unit checked.

\*1: Models with the keyless access system have an **ENGINE START/STOP** button instead of an ignition switch.

\* Not available on all models

### ▶▶ HDMI™ Port\*

- Do not leave the HDMI™ connected device in the vehicle. Direct sunlight and high temperatures may damage it.
- We recommend backing up your data before using the device in your vehicle.
- Displayed messages may vary depending on the device model and software version.

The terms HDMI and HDMI High-Definition Multimedia Interface, and the HDMI Logo are trademarks or registered trademarks of HDMI Licensing LLC in the United States and other countries.

## Audio Remote Controls

Allow you to operate the audio system while driving. The information is shown on the driver information interface.

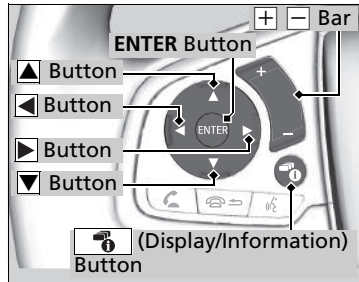

### ▲ ▼ Buttons

Press ▲ or ▼ to cycle through the audio mode as follows:

#### Models with Display Audio

FM→DAB\*→LW\*→MW\*→AM\*→USB→  
iPod→Bluetooth® Audio→Apps→  
Audio Apps→AUX-HDMI™

#### Models with colour audio system

FM1→FM2→DAB1\*→DAB2\*→LW→MW→  
USB→iPod→Bluetooth® Audio

#### Models with Display Audio

##### ENTER Button

- When listening to the radio
  1. Press **ENTER** to switch the display to a preset list you stored in the preset buttons.
  2. Press ▲ or ▼ to select a preset, then press **ENTER**.
- When listening to a USB flash drive
  1. Press **ENTER** to display the folder list.
  2. Press ▲ or ▼ to select a folder.
  3. Press **ENTER** to display a list of files in that folder.
  4. Press ▲ or ▼ to select a file, then press **ENTER**.
- When listening to an iPod
  1. Press **ENTER** to display the iPod music list.
  2. Press ▲ or ▼ to select a category.
  3. Press **ENTER** to display a list of items in the category.

#### Audio Remote Controls

Some modes appear only when an appropriate device or medium is used.







Depending on the Bluetooth® device you connect, some functions may not be available.

Press the  (Hang-up/back) button\* to go back to the previous command or cancel a command.

Press the  (Display/information) button to switch the display.

➤ **Switching the Display** P. 316











4. Press  or  to select an item, then press **ENTER**.
  - ▶ Press **ENTER** and press  or  repeatedly until the desired mode you want to listen to is displayed.
  - When listening to *Bluetooth*<sup>®</sup> Audio
    1. Press **ENTER** to display the track list.
    2. Press  or  to select a track, then press **ENTER**.

#### (Volume) Bar

**Press** : To increase the volume.

**Press** : To decrease the volume.

#### Buttons

- When listening to the radio
  - Press** : To select the next preset radio station.
  - Press** : To select the previous preset radio station.
  - Press and hold** : To select the next strong station.  
To select the next ensemble (DAB\*).
  - Press and hold** : To select the previous strong station.  
To select the previous ensemble (DAB\*).
- When listening to an iPod, USB flash drive, or *Bluetooth*<sup>®</sup> Audio
  - Press** : To skip to the next song.
  - Press** : To go back to the beginning of the current or previous song.
- When listening to a USB flash drive
  - Press and hold** : To skip to the next folder.
  - Press and hold** : To go back to the previous folder.

\* Not available on all models

# Audio System Basic Operation

## Models with colour audio system

To use the audio system, the ignition switch must be in ACCESSORY  or ON .

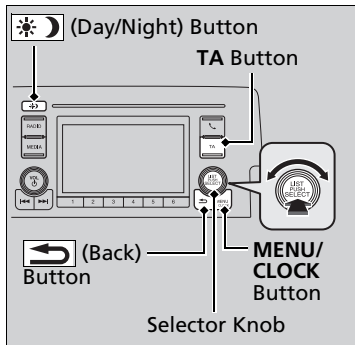

Use the selector knob or **MENU/CLOCK** button to access some audio functions.

Press  to switch between the normal and extended display for some functions.

### Selector knob:

Rotate left or right to scroll through the available choices. Press  to set your selection.

**MENU/CLOCK button:** Press to select any mode.

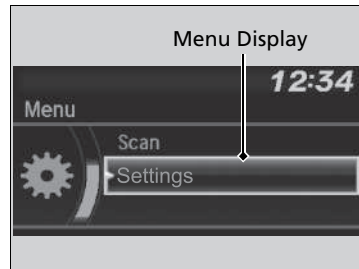

The available modes include wallpaper, display, clock, language setup, and play modes. Play mode choices include scan, random, repeat, and so on.

 **(Back) button:** Press to go back to the previous display.



**TA button:** Press to activate the TA station.

 **(Day/Night) button:** Press to change the audio/information screen brightness.

Press , then adjust the brightness using .

- ▶ Each time you press , the mode switches between the daytime mode, nighttime mode and **OFF** mode.

## Audio System Basic Operation

These indications are used to show how to operate the selector knob.

Rotate  to select.

Press  to enter.

### Menu Items

- ▶ **Adjust Clock** P. 186
- ▶ **Wallpaper Setup** P. 293
- ▶ **Adjusting the Sound** P. 295
- ▶ **Display Setup** P. 296
- ▶ **Customized Features** P. 396

Press the button on the steering wheel to change any audio setting.

- ▶ **Audio Remote Controls** P. 288

## Audio/Information Screen

Displays the audio status and wallpaper. From this screen, you can go to various setup options.

### ■ Switching the Display

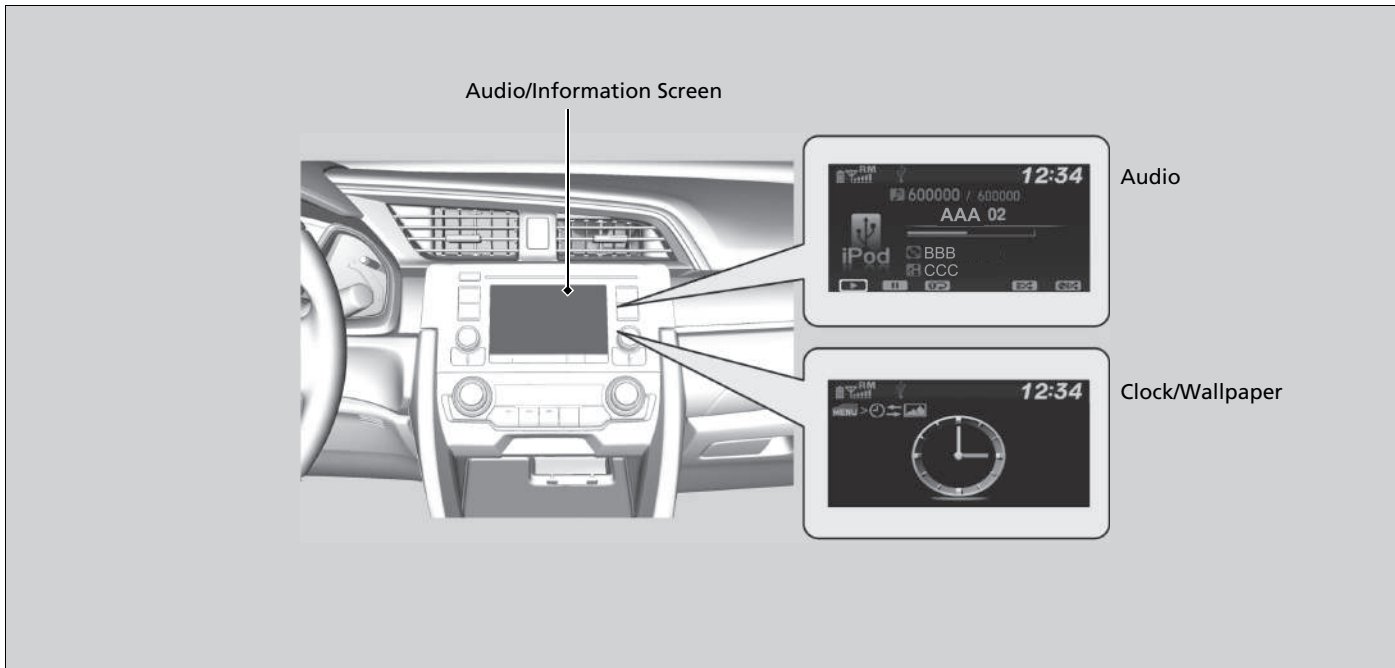







### ■ Audio

Shows the current audio information.

### ■ Clock/Wallpaper

Shows a clock screen or an image you import.

### ■ Change display

1. Press the **MENU/CLOCK** button.
2. Rotate  to select **Settings**, then press .
3. Rotate  to select **Display change**, then press .
4. Rotate  to select **Wallpaper**, then press 
  - ▶ If you want to return to the audio/information screen, select **Audio**.

## ■ Wallpaper Setup

You can change, store, and delete the wallpaper on the audio/information screen.

### ■ Import wallpaper

You can import up to three images, one at a time, for wallpaper from a USB flash drive.

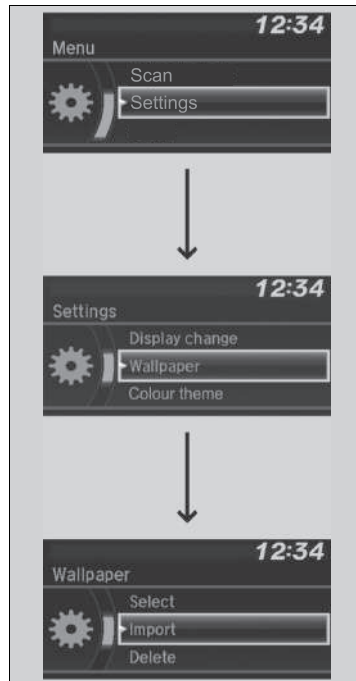









1. Connect the USB flash drive to the USB port.  
 ▶ **USB Port(s)** P. 285
2. Press the **MENU/CLOCK** button.
3. Rotate to select **Settings**, then press .
4. Rotate to select **Wallpaper**, then press .
5. Rotate to select **Import**, then press .  
 ▶ The picture name is displayed on the list.
6. Rotate to select a desired picture, then press .  
 ▶ The selected picture is displayed.
7. Press to save the picture.
8. Press to select **OK**.
9. Rotate to select a location to save the picture, then press .  
 ▶ The display will return to the wallpaper setting screen.

### ▶▶ Wallpaper Setup











- When importing wallpaper files, the image must be in the USB flash drive's root directory. Images in a folder cannot be imported.
- The file name must be fewer than 64 characters.
- The file format of the image that can be imported is BMP (bmp) or JPEG (jpg).
- The individual file size limit is 2 MB.
- The maximum image size is 1,920 × 936 pixels. If the image size is less than 480 × 234 pixels, the image is displayed in the middle of the screen with the extra area appearing in black.
- Up to 255 files can be selected.
- If the USB flash drive does not have any pictures, the error message appears.

Continued

### ■ Select wallpaper

1. Press the **MENU/CLOCK** button.
2. Rotate  to select **Settings**, then press .
3. Rotate  to select **Wallpaper**, then press .
4. Rotate  to select **Select**, then press 
  - ▶ The screen changes to the wallpaper list.
5. Rotate  to select a desired wallpaper, then press .

### ■ Delete wallpaper

1. Press the **MENU/CLOCK** button.
2. Rotate  to select **Settings**, then press .
3. Rotate  to select **Wallpaper**, then press .
4. Rotate  to select **Delete**, then press 
  - ▶ The screen changes to the wallpaper list.
5. Rotate  to select a wallpaper that you want to delete, then press .
6. Rotate  to select **Yes**, then press 
  - ▶ The display will return to the wallpaper setting screen.

### ▣ Wallpaper Setup

To go back to the previous screen, press the  (Back) button.

When the file size is large, it takes a while to be previewed.

## Adjusting the Sound

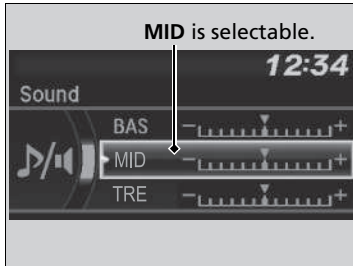
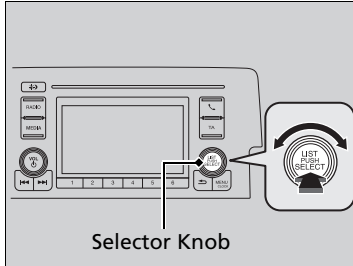

Press the **MENU/CLOCK** button and rotate to select **Sound**, then press . Rotate to scroll through the following choices:

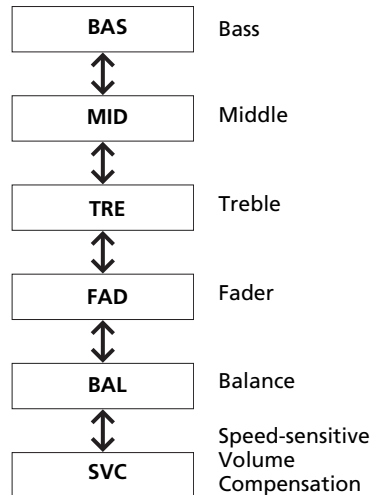

Rotate to adjust the sound setting, then press .

### Adjusting the Sound









The SVC has four modes: **Off**, **Low**, **Mid**, and **High**. SVC adjusts the volume level based on the vehicle speed. As you go faster, audio volume increases. As you slow down, audio volume decreases.

## Display Setup

You can change the brightness or colour theme of the audio/information screen.







### Changing the Screen Brightness

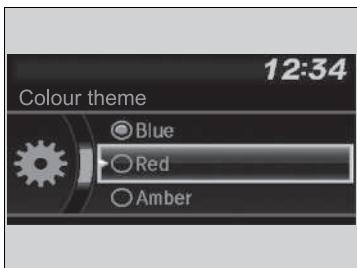

1. Press the **MENU/CLOCK** button.
2. Rotate  to select **Settings**, then press .
3. Rotate  to select **Display adjustment**, then press .
4. Rotate  to select **Brightness**, then press .
5. Rotate  to adjust the setting, then press .

### Changing the Screen's Colour Theme



1. Press the **MENU/CLOCK** button.
2. Rotate  to select **Settings**, then press .
3. Rotate  to select **Colour theme**, then press .
4. Rotate  to select the setting you want, then press .

### Changing the Screen Brightness

You can change the **Contrast** and **Black level** settings in the same manner.



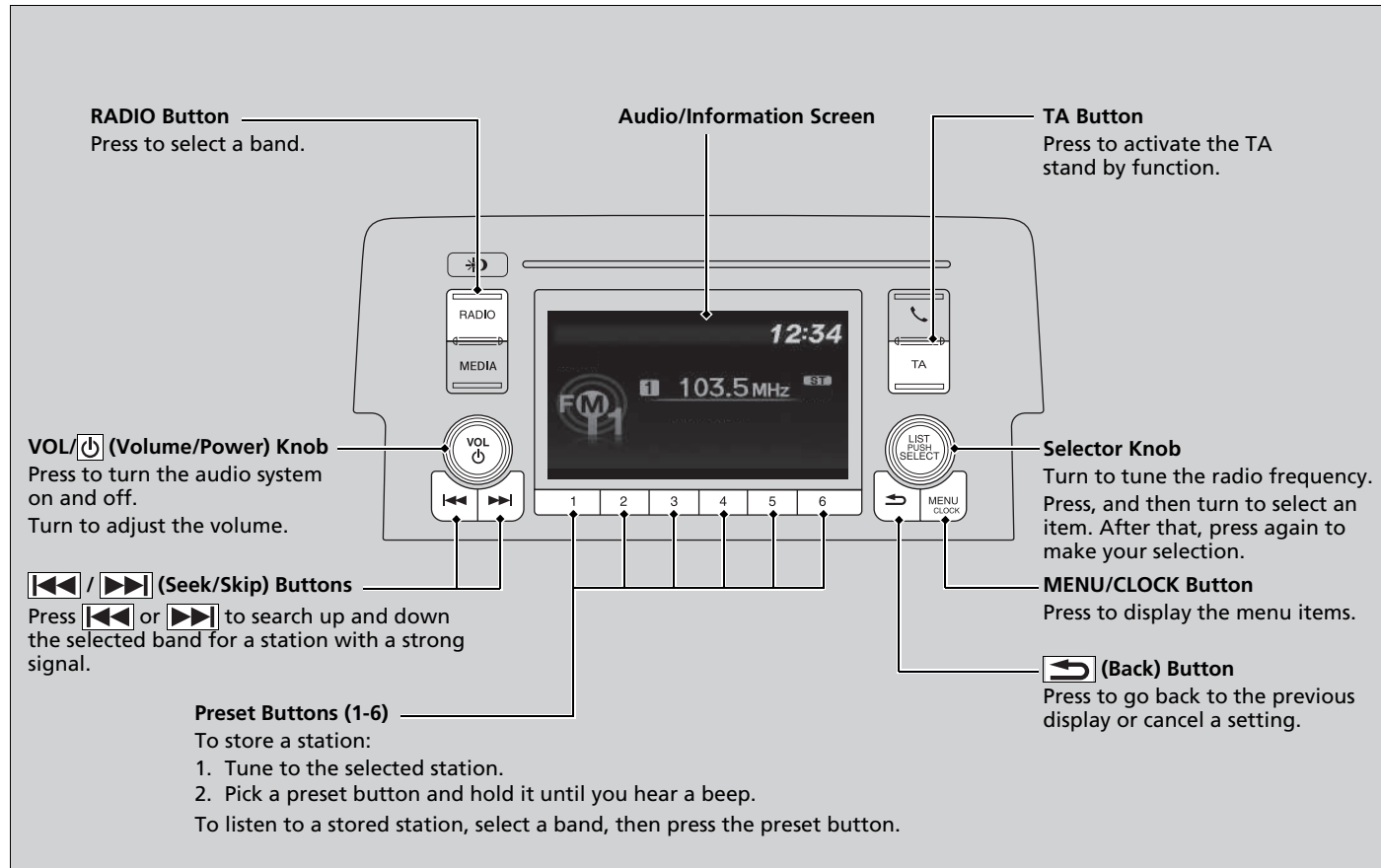

## Playing AM/FM Radio



## ■ Radio Data System (RDS)



Provides convenient automated services related to your selected RDS-capable FM station.

### ■ To find an RDS station from Station List

1. Press  while listening to an FM station.
2. Rotate  to select the station, then press .







### ■ Update List

Updates your available station list at any time.

1. Press  while listening to an FM station.
2. Rotate  to select **Update list**, then press .

### ■ Radio text

Displays the radio text information of the selected RDS station.

1. Press the **MENU/CLOCK** button.
2. Rotate  to select **Settings**, then press .
3. Rotate  to select **RDS settings**, then press .
4. Rotate  to select **Radio text**, then press 
  - ▶ Select **Radio text** again to turn it off.

## ▣ Playing AM/FM Radio

The **ST** indicator appears on the display indicating stereo FM broadcasts.

Stereo reproduction in AM is not available.

You can store 12 AM stations and 12 FM stations into the preset button memory. AM has two types of frequencies LW and MW, and each lets you store six stations. FM1 and FM2 let you store six stations each.

Switching the Audio Mode

Press the audio source selecting button on the steering wheel.

▶ **Audio Remote Controls** P. 288

## ▣ Radio Data System (RDS)







When you select an RDS-capable FM station, the RDS automatically turns on, and the frequency display changes to the station name. However, when the signals of that station become weak, the display changes from the station name to the frequency.

Turning the Alternative Frequency (AF) function on and off turns the RDS on and off.

Pressing  switches the function between on and off.







**■ Alternative Frequency (AF)**

Automatically changes the frequency of the same programme as you enter different regions.

1. Press the **MENU/CLOCK** button.
2. Rotate  to select **Settings**, then press .
3. Rotate  to select **RDS settings**, then press .
4. Rotate  to select **AF**, then press .
  - ▶ Select **AF** again to turn it off.

**■ Regional Programme (REG)**







Keeps the same frequency of the stations within that region even if the signal gets weak.

1. Press the **MENU/CLOCK** button.
2. Rotate  to select **Settings**, then press .
3. Rotate  to select **RDS settings**, then press .
4. Rotate  to select **REG**, then press .
  - ▶ Select **REG** again to turn it off.

Except AM/FM/DAB\* mode



**■ News Programme (News)**

Automatically tunes to the news programme.

1. Press the **MENU/CLOCK** button.
2. Rotate  to select **Settings**, then press .
3. Rotate  to select **RDS settings**, then press .
4. Rotate  to select **News**, then press .
  - ▶ Select **News** again to turn it off.

\* Not available on all models

**▶▶ Radio Data System (RDS)**

If the system cannot find any station on **Station list**, a confirmation message for updating the list appears. Rotate  to select **Yes**, then press  to update the list.

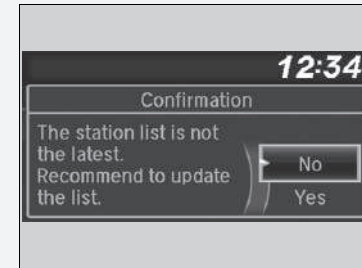

Continued

### ■ Traffic announcement (TA) button

TA standby function allows the system to stand by for traffic announcements in any mode. The last tuned station must be an RDS-capable traffic programme station.

**To turn the function on:** Press the **TA** button. When a traffic announcement begins on your last tuned station, the system automatically switches to the FM mode. TA-INFO appears on the display. The system returns to your last selected mode after the traffic announcement is finished.

If you want to go back to your last selected mode during the traffic announcement, press the **TA** button again.

**To cancel the function:** Press the **TA** button.

### ☒ Radio Data System (RDS)

#### TA

When you press the **TA** button, the **TA** indicator appears on the display.

If you select **Scan** while the TA standby function is on, the system searches TP station only.

Pressing the **TA** button while the traffic announcement is on does not cancel the TA standby function.

Except AM/FM/DAB\* mode

### ■ Programme type (PTY)/News interrupt function

Allows the system to interrupt with a newscast in any mode. The last tuned station must be the NEWS PTY coded station.

**To activate the function:** Select **News** from **RDS settings** and display the NEWS PTY before changing to other modes. When a newscast begins on your last tuned station, the system automatically switches to the FM mode.

➤ **News Programme (News)** P. 299

The system returns to your last selected mode if changed to another programme, or signal gets weak.



### ■ PTY alarm

The PTY code, ALARM is used for emergency announcements, such as natural disasters. When this code is received, ALARM appears on the display and the system interrupts your audio operation.

\* Not available on all models

## ■ Station List

Lists the strongest stations on the selected band.

1. Press  while listening to a radio.
2. Rotate  to select the station, then press .

## ■ Update List

Updates your available station list at any time.

1. Press  while listening to a radio.
2. Rotate  to select **Update list**, then press .



## ■ Scan

Samples each of the strongest stations on the selected band for 10 seconds.

1. Press the **MENU/CLOCK** button.
2. Rotate  to select **Scan**, then press .

To turn off scan, press .

## ☒ Station List

If the system cannot find any station on **Station list**, a confirmation message for updating the list appears. Rotate  to select **Yes**, then press  to update the list.

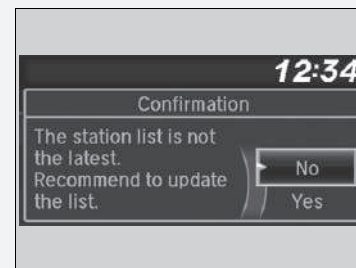

## Playing DAB (Digital Audio Broadcasting)\*

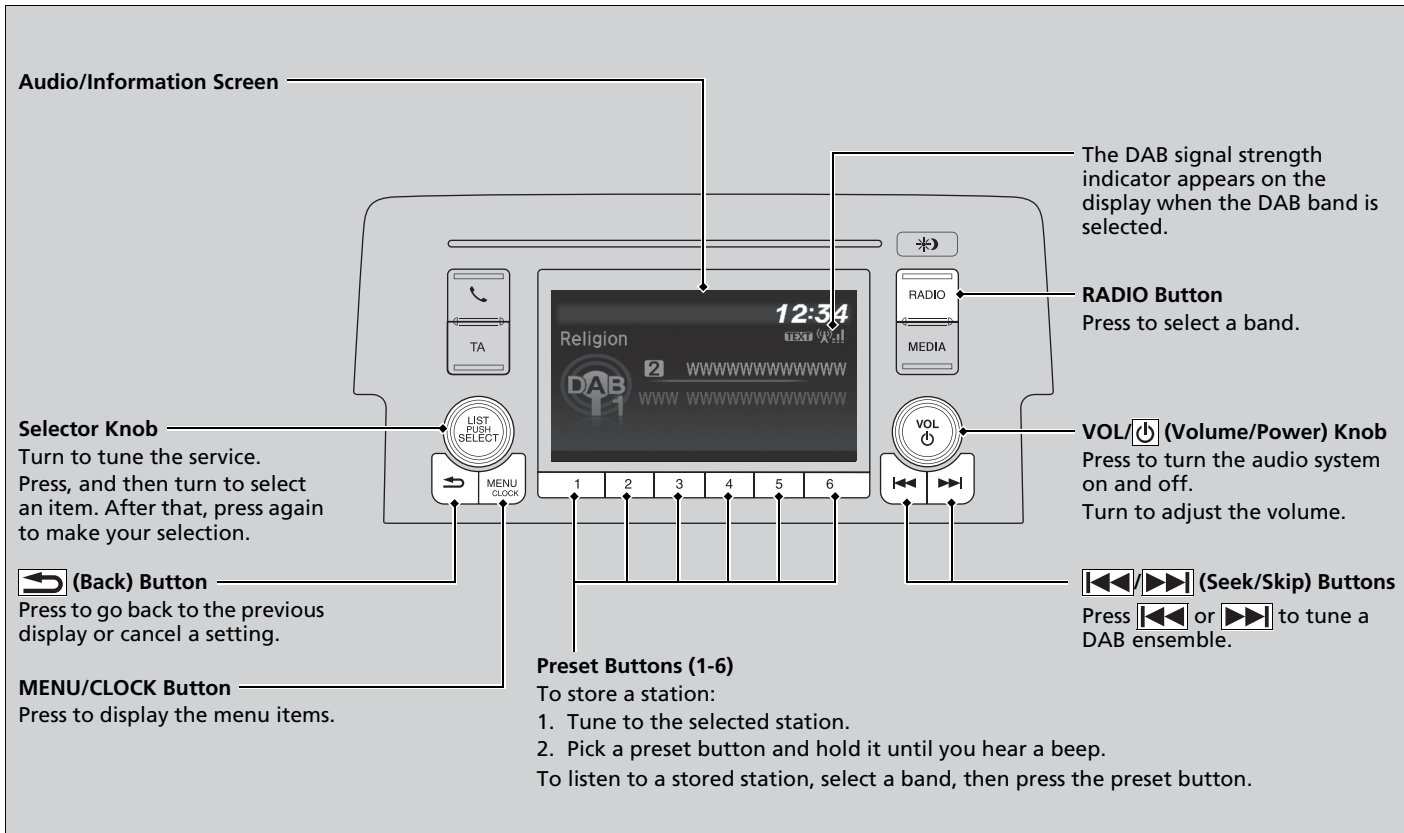



\* Not available on all models





## Service List and Ensemble List

### ■ To find an DAB station from Service List or Ensemble List

To find a DAB station from the service list:

1. Press  while selecting the DAB mode.
2. Rotate  to select the station, then press .
- ▶ If you select **Update list**, the system update the station list.

To find a DAB station from the ensemble list:

1. Press  while selecting the DAB mode.
2. Rotate  to select **Ensemble list**, then press .
3. Rotate  to select the ensemble, then press .
- ▶ If you select **Update list**, the system update the ensemble list.

### ■ Scan







Samples each of the strongest stations on the selected band for 10 seconds.

1. Press the **MENU/CLOCK** button.
2. Rotate  to select **Scan**, then press .

To turn off scan, press .

### ■ Radio Text:

Displays the radio text information of the selected DAB station.

1. Press the **MENU/CLOCK** button.
2. Rotate  to select **Settings**, then press .
3. Rotate  to select **DAB settings**, then press .
4. Rotate  to select **Radio text**, then press .
- ▶ Select **Radio text** again to turn it off.



### ☒ Service List and Ensemble List

You can store 12 DAB stations into the preset button memory. DAB1 and DAB2 let you store 6 stations each.

#### Switching the Audio Mode

Press the audio source selecting button on the steering wheel.

☒ **Audio Remote Controls** P. 288

If the system cannot find a station, a confirmation message for updating the list appears. Rotate  to select **Yes**, then press  to update the list.

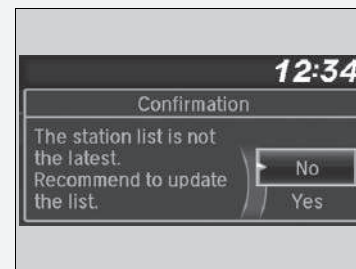







### ☒ Radio Text:

The **TEXT** indicator appears on the display indicating radio text information.









**■ DAB-Link:**

Automatically searches for the same station from Ensembles, and switches to it.

1. Press the **MENU/CLOCK** button.
2. Rotate  to select **Settings**, then press .
3. Rotate  to select **DAB settings**, then press .
4. Rotate  to select **DAB-Link**, then press .
  - ▶ Select **DAB-Link** again to turn it off.









**■ FM-Link:**

If the system finds the same station from an FM band, it automatically switches the band.

1. Press the **MENU/CLOCK** button.
2. Rotate  to select **Settings**, then press .
3. Rotate  to select **DAB settings**, then press .
4. Rotate  to select **FM-Link**, then press .
  - ▶ Select **FM-Link** again to turn it off.

**■ Band select:**

You can select specific bands. This can reduce the time to update the lists, and search for a station.

1. Press the **MENU/CLOCK** button.
2. Rotate  to select **Settings**, then press .
3. Rotate  to select **DAB settings**, then press .
4. Rotate  to select **Band select**, then press .
5. Rotate  to select **Both**, **BandIII** or **L-Band**, then press .

## Playing an iPod

Connect the iPod using your USB connector to the USB port, then press the **MEDIA** button.

🔌 **USB Port(s)** P. 285

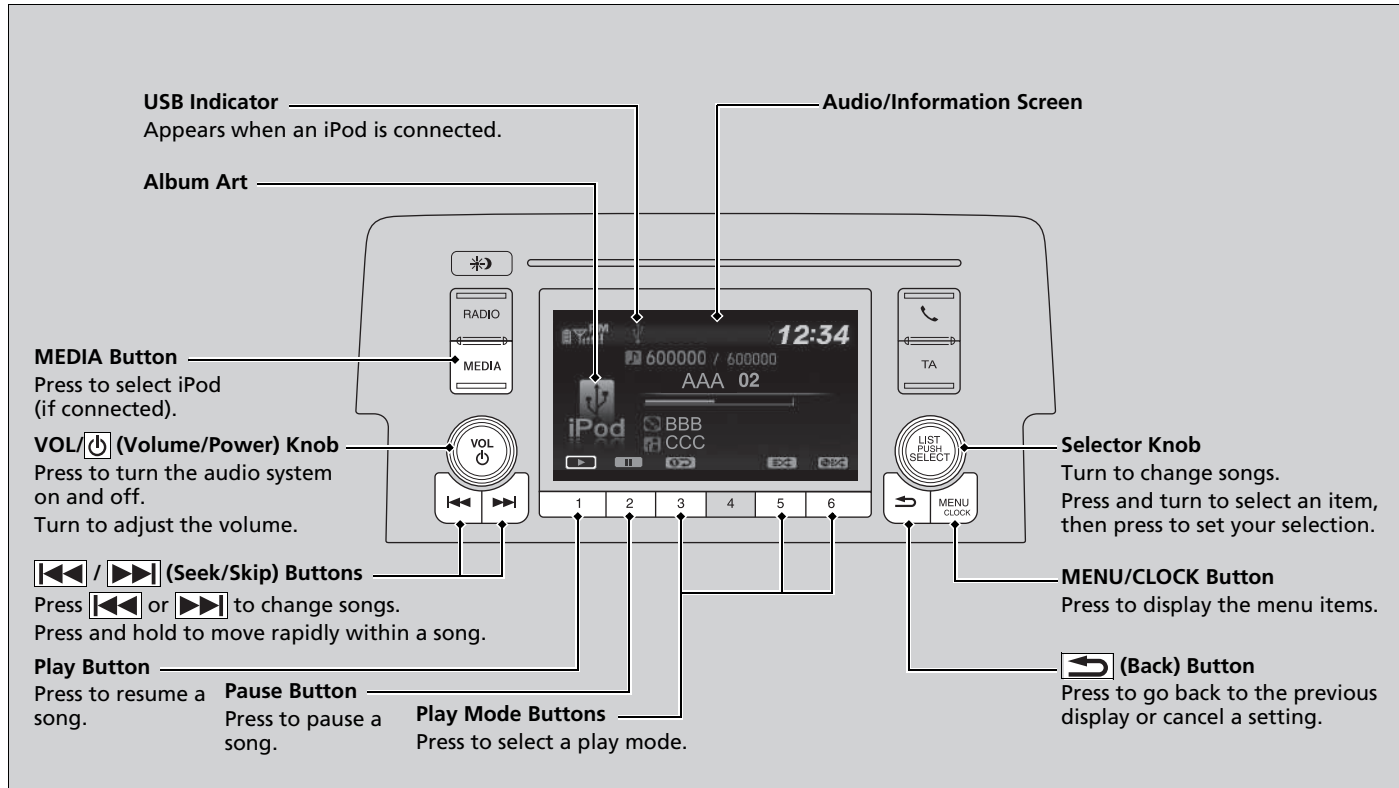

## How to Select a Song from the iPod Music List with the Selector Knob



1. Press to display the iPod music list.

2. Rotate to select a category.

3. Press to display a list of items in the category.

4. Rotate to select an item, then press .

- ▶ Press and rotate repeatedly until a desired item you want to listen is displayed.

### ▶▶▶ Playing an iPod

Available operating functions vary on models or versions. Some functions may not be available on the vehicle's audio system.

If there is a problem, you may see an error message on the audio/information screen.

**iPod/USB Flash Drive** P. 380

## How to Select a Play Mode

You can select repeat and shuffle modes when playing a song.

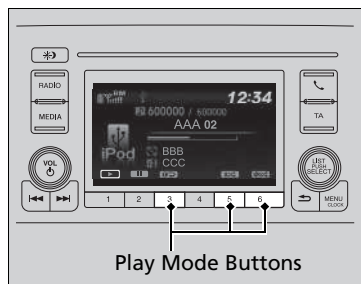

Play Mode Buttons

Available mode icons appear above the play mode buttons.

Press the button corresponding to the mode you want to select.

### To turn off a play mode

Press the selected button.

## How to Select a Play Mode

Play Mode Menu Items



 **Shuffle albums:** Plays all available albums in a selected category (playlists, artists, albums, songs, genres, or composers) in random order.



 **Random all:** Plays all available songs in a selected category (playlists, artists, albums, songs, genres, or composers) in random order.

 **Repeat one track:** Repeats the current song.

You can also select a play mode by pressing the **MENU/CLOCK** button.

Rotate  to select **Play mode**, then press .

Rotate  to select a mode, then press .

To turn it off, rotate  to select **Normal play**, then press .

## Playing a USB Flash Drive

Your audio system reads and plays sound files on a USB flash drive in either MP3, WMA or AAC\*1 format.

Connect your USB flash drive to the USB port, then press the **MEDIA** button.



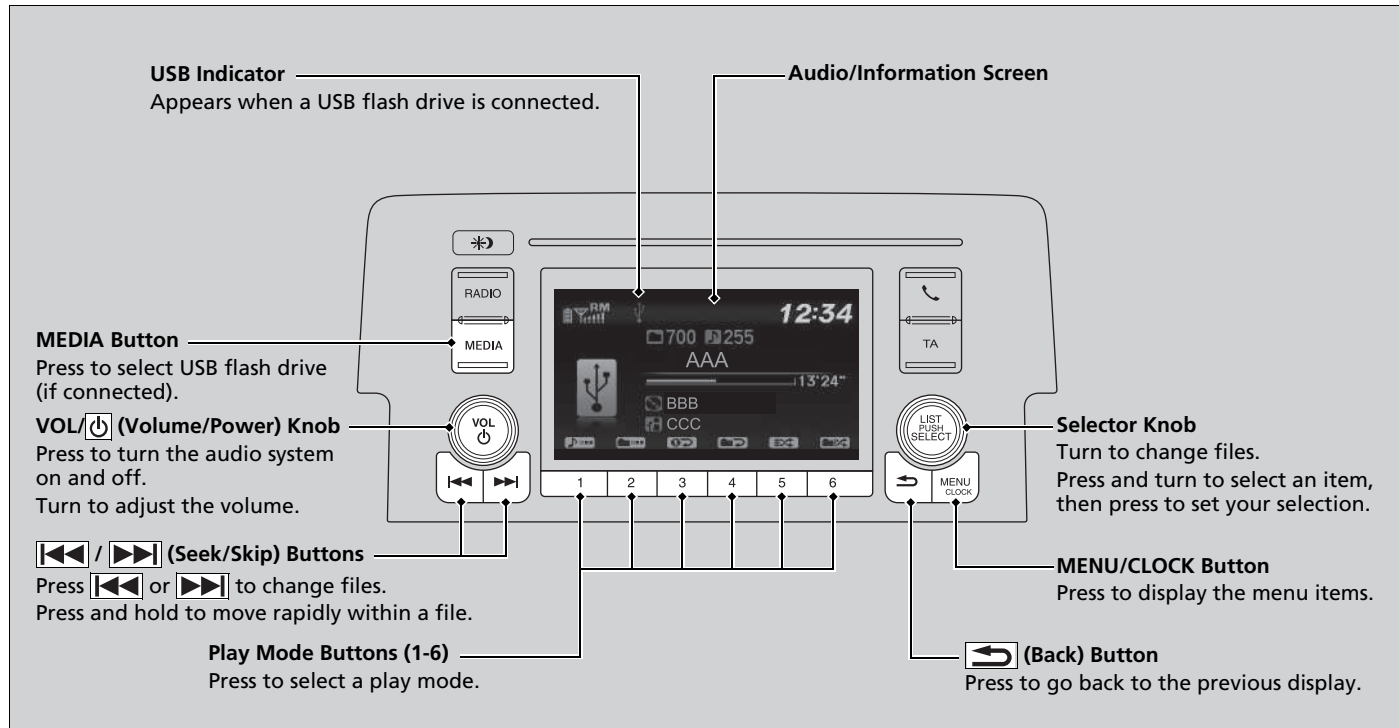

➤ **USB Port(s)** P. 285

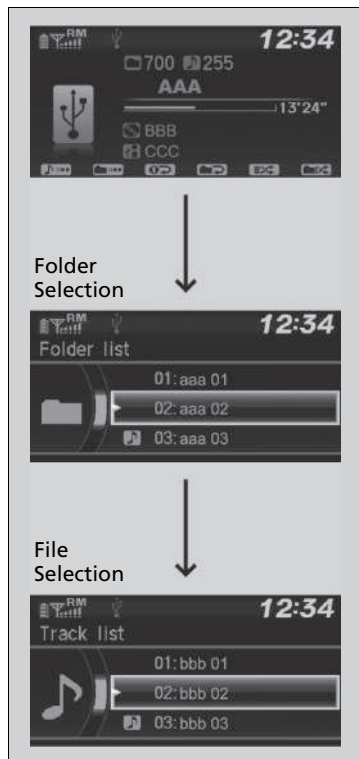

\*1: Only AAC format files recorded with iTunes are playable on this unit.

## How to Select a File from a Folder with the Selector Knob



1. Press  to display a folder list.
2. Rotate  to select a folder.
3. Press  to display a list of files in that folder.
4. Rotate  to select a file, then press .

## ▶▶ Playing a USB Flash Drive

Use the recommended USB flash drives.

▶ **General Information on the Audio System**  
P. 382

Files in WMA format protected by digital rights management (DRM) cannot be played. The audio system displays **Unplayable file**, and then skips to the next file.

If there is a problem, you may see an error message on the audio/information screen.

▶ **iPod/USB Flash Drive** P. 380

## How to Select a Play Mode

You can select repeat, random, and scan modes when playing a file.

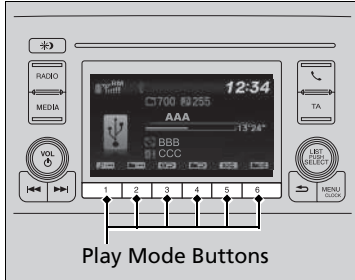

Play Mode Buttons

Available mode icons appear above the play mode buttons.

Press the button corresponding to the mode you want to select.

### To turn off a play mode

Press the selected button.

## How to Select a Play Mode

Play Mode Menu Items

### Repeat

**Repeat one folder:** Repeats all files in the current folder.

**Repeat one track:** Repeats the current file.

### Random

**Random in folder:** Plays all files in the current folder in random order.

**Random all:** Plays all files in random order.

### Scan

**Scan folders:** Provides 10-second sampling of the first file in each of the main folders.

**Scan tracks:** Provides 10-second sampling of all files in the current folder.

You can also select a play mode by pressing the **MENU/CLOCK** button.

Rotate to select **Play mode**, then press .

Rotate to select a mode, then press .

To turn it off, rotate to select **Normal play**, then press .

## Playing *Bluetooth*® Audio

Your audio system allows you to listen to music from your *Bluetooth*-compatible phone.

This function is available when the phone is paired and connected to the vehicle's Hands-Free Telephone (HFT) system.

☑ **Phone Setup** P. 436

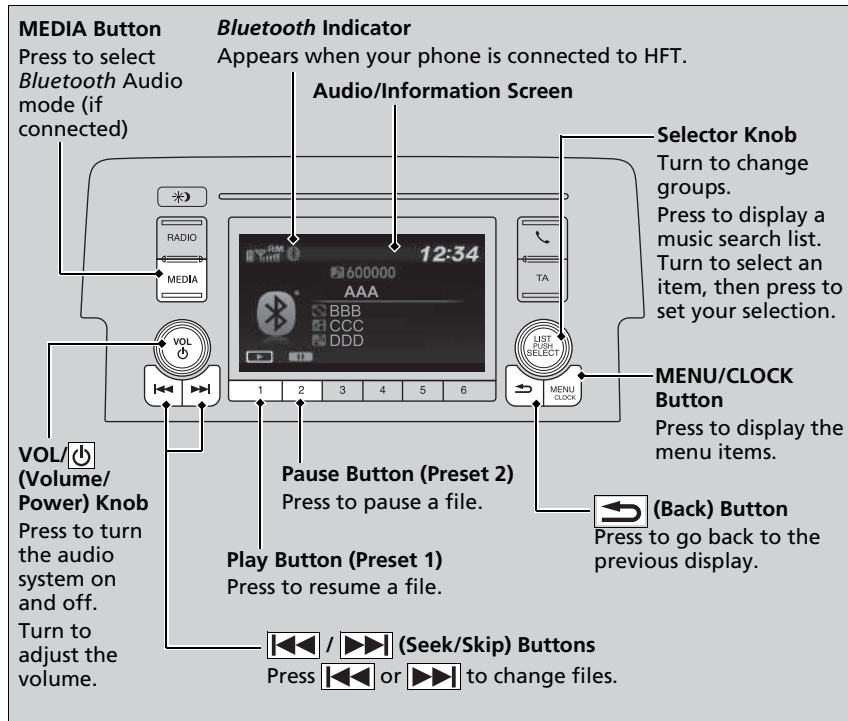

### ▶▶ Playing *Bluetooth*® Audio

Not all *Bluetooth*-enabled phones with streaming audio capabilities are compatible with the system. To check if your phone is compatible, ask a dealer.

In some countries, it may be illegal to perform some data device functions while driving.

Only one phone can be used with HFT at a time. When there are more than two paired phones in the vehicle, the first paired phone the system finds is automatically connected.

If more than one phone is paired to the HFT system, there will be a delay before the system begins to play.

In some cases, the name of the artist, album, or track may not appear correctly.

Some functions may not be available on some devices.



### ■ To Play *Bluetooth*® Audio Files

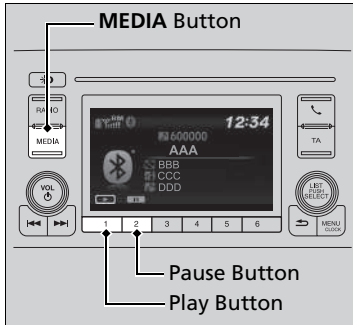

1. Make sure that your phone is paired and connected to HFT.
2. Press the **MEDIA** button until the *Bluetooth*® Audio mode is selected.

If the phone is not recognised, another HFT-compatible phone, which is not compatible for *Bluetooth*® Audio, may already be connected.

### ■ To pause or resume a file

Press the **Play** or **Pause** button to select a mode.

### ▣ To Play *Bluetooth*® Audio Files

To play the audio files, you may need to operate your phone. If so, follow the phone maker's operating instructions.

The pause function may not be available on some phones.

If any audio device is connected to the USB port, you may need to press the **MEDIA** button repeatedly to select the *Bluetooth*® Audio system.

Switching to another mode pauses the music playing from your phone.



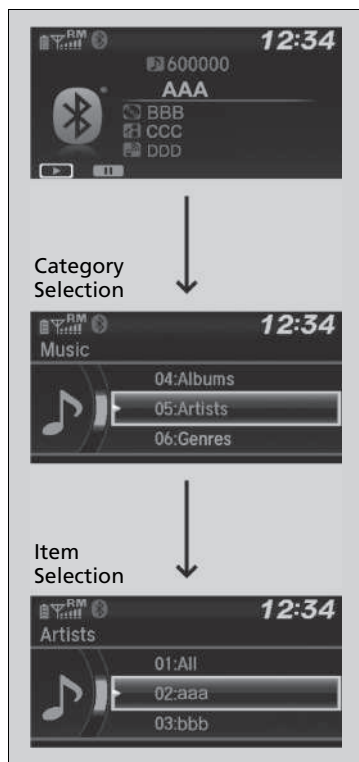

## How to Select a Song from the Music Search List with the Selector Knob



1. Press  to display the music search list.

2. Rotate  to select a category.

3. Press  to display a list of items in the category.



4. Rotate  to select an item, then press .  
▶ Press  and rotate  repeatedly until a desired item you want to listen is displayed.

### How to Select a Song from the Music Search List with the Selector Knob

Depending on the *Bluetooth*® device you connect, some or all of the categories may not be displayed.

# Audio System Basic Operation

## Models with Display Audio

To use the audio system function, the ignition switch must be in ACCESSORY  or ON \*1.

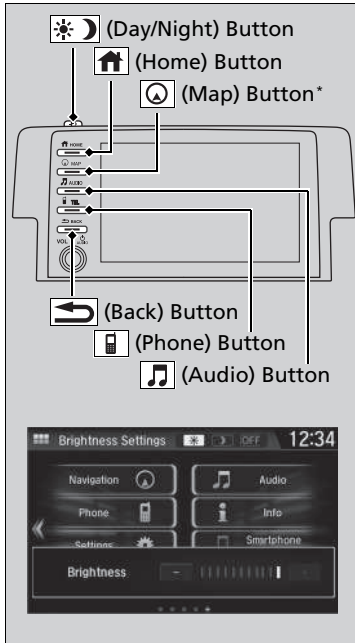

 **(Home) button:** Press to go to the home screen.

 **Using the audio/information screen**  
P. 317





 **(Map) button\*:** Press to display the map screen.

 **Refer to the Navigation System Manual**

 **(Audio) button:** Press to display the audio screen.

 **(Phone) button:** Press to display the phone screen.

 **(Back) button:** Press to go back to the previous screen.

 **(Day/Night) button:** Press to change the audio/information screen brightness. Press  once and select  or  to make an adjustment.

▶ Each time you press , the mode switches among the daytime mode, nighttime mode and off mode.



\*1: Models with the keyless access system have an **ENGINE START/STOP** button instead of an ignition switch.

\* Not available on all models

## Audio System Basic Operation

### Models with DAB

You can use the audio system for 30 minutes when the ignition switch is in LOCK \*1 position, the system will then turn off automatically.

If you want to keep using it, we recommend that you turn the ignition switch to ACCESSORY  or ON \*1.

### Key Off Operation\*

 **Key Off Operation\*** P. 284

## Audio/Information Screen

Displays the audio status and wallpaper. From this display, you can go to various setup options.

### ■ Switching the Display

#### ■ Using the button

Press the  button to change the display.

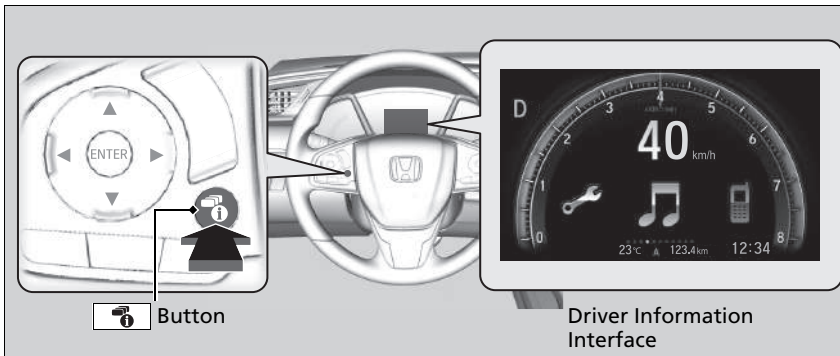



#### ▣ Using the button

You can edit, add, and delete the contents shown on the driver information interface.

#### ▣ Customizing the Meter P. 320

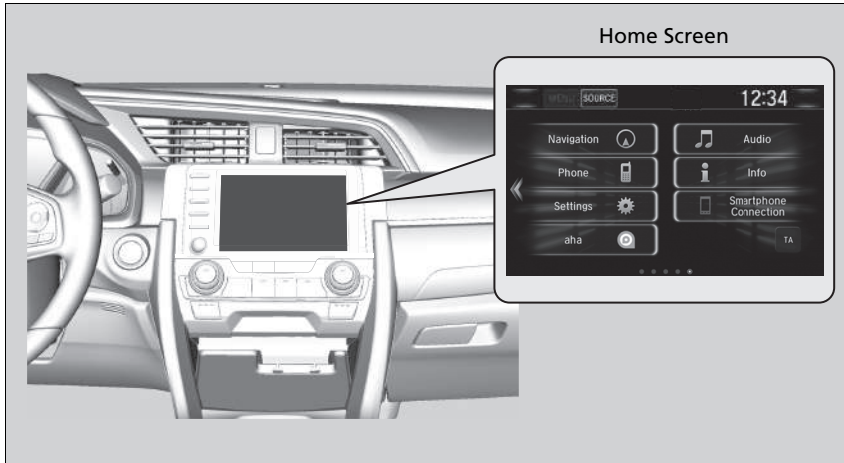
## ■ Using the audio/information screen



Press the  button to go to the home screen.  
Select the following icons on the home screen.

### ■ Phone

Displays the HFT information.

➤ **Hands-Free Telephone System** P. 451

## ▣ Using the audio/information screen

### Touchscreen operation

- Use simple gestures - including touching, swiping and scrolling - to operate certain audio functions.
- Some items may be greyed out during driving to reduce the potential for distraction.
- You can select them when the vehicle is stopped or use voice commands\*.
- Wearing gloves may limit or prevent touchscreen response.

You can change the touchscreen sensitivity setting.

➤ **Customized Features** P. 396

\* Not available on all models

## ■ Info

Displays **Trip Computer**, **Voice Info\***, **Clock/wallpaper**, or **System/Device Information**. Select **MENU** on the **Info Menu** screen to see all available options: **Trip Computer**, **Voice Info\***, **Clock/wallpaper** and **System/Device Information**.

### Trip Computer:

- **Current Drive** tab: Displays the current trip information.
- **History of Trip A** tab: Displays information for the three previous drives. The information is stored every time you reset Trip A.  
To delete the history manually, select **Delete history** on the **History of Trip A** tab. The confirmation message appears on the screen, then select **Yes**.

**Voice Info\***: Displays a list of all voice commands.

**Clock/wallpaper**: Displays the clock and wallpaper.

### System/Device Information:

- **System Info**: Displays the software version of the audio system.
- **USB info**: Displays the memory usage of the USB device.

## ■ Audio

Displays the current audio information.

## ■ Settings

Enters the customizing menu screen.

🔧 **Customized Features** P. 396

### ■ Navigation\*

Displays the navigation screen.

➤ **Refer to the Navigation System Manual**

### ■ Smartphone Connection

Connects with your smartphone\*<sup>1</sup> and allows some apps on your smartphone to be used on the audio system.

➤ **Apple CarPlay** P. 373

➤ **Android Auto** P. 376

### ■ aha\*

Displays the Aha™ screen.

➤ **Playing Aha™\*** P. 357

### ■ App Centre\*

Displays Honda App Center.

➤ **On Board Apps\*** P. 365

### ■ TA\*

Turns on and off the traffic information.

### ■ App List

Adds or removes apps or widgets on the home screen.

➤ **Home Screen** P. 326

### ■ (Instrument Panel)

Selects from three customizable settings for the driver information interface.

\*1: Available on specific phones only. Ask a dealer for compatible phones for feature details.

\* Not available on all models

*Continued*

## Changing the Home Screen Icon Layout



1. Press the  button.
2. Select and hold an icon.
  - ▶ The screen switches to the customization screen.
3. Drag and drop the icon to where you want it to be.
4. Select **OK**.
  - ▶ The screen will return to the home screen.

## Customizing the Meter

You can edit, add, or delete the meter contents on the driver information interface.

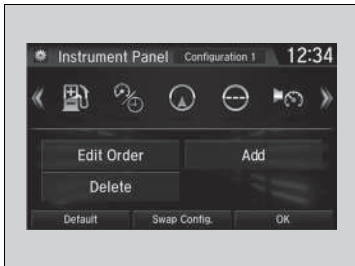

1.  button
2. **Settings**
3. **System**
4. **Configuration of Instrument Panel**

### Customizing the Meter

You can store up to three customized configurations. To select or customize a configuration, press **Swap Config.**

When you select **Swap Config.** during customization, the settings you changed will be saved.

When you press the  button during customization, the settings you changed will not be saved and you will be returned to the **Instrument Panel** screen.



## ■ Editing order

To change the order of the icons on the driver information interface, first select:

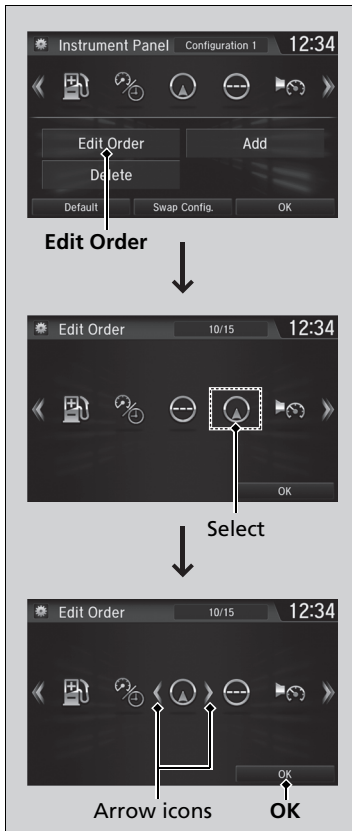

### 1. Edit Order

### 2. Select the icon you want to move.

- ▶ You will see arrows on both sides of the selected icon.

### 3. Select the left or right arrow repeatedly to move the icon to your desired position.

### 4. Select **OK**.

- ▶ The screen will return to the **Instrument Panel** screen.

### ▶▶ Editing order

You can use an alternative method to change the order of the icons. First select:

#### 1. **Edit Order**

2. Select and hold the icon you want to move.
3. Drag and drop the icon to where you want it to be.
4. Select **OK**.

- ▶ The screen will return to the **Instrument Panel** screen.

Continued

## ■ Adding contents

You can add icons to the driver information interface. To add icons, first select:

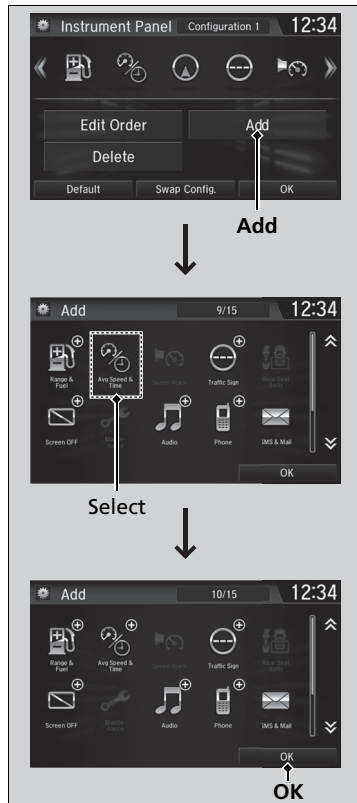

### 1. Add

### 2. Select an icon you want to add.

- ▶ You will see a plus mark on the upper right hand corner of the selected icon.

### 3. Select **OK**.

- ▶ The screen will return to the **Instrument Panel** screen.

## ▣ Adding contents

Icons that are grayed out cannot be selected.

If an icon has a plus mark in the upper-right corner, it means that the icon has already been added.

## ■ Deleting contents

To delete contents on the driver information interface, first select:

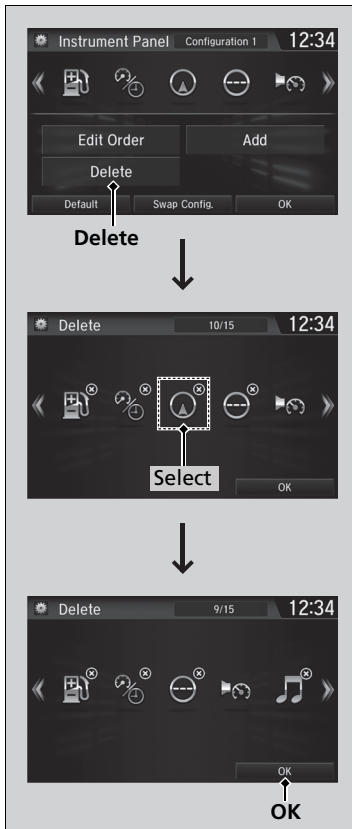

### 1. Delete

### 2. Select an icon you want to delete.

- ▶ The icon with an **X** on the upper right hand corner can be deleted.

### 3. Select **OK**.

- ▶ The screen will return to the **Instrument Panel** screen.

### ▣ Deleting contents

You can also delete contents by selecting:

1. **Delete** or **Edit Order**
2. Select and hold an icon you want to delete.
3. Drag and drop the icon to the trash icon.
4. Select **OK**.

- ▶ The screen will return to the **Instrument Panel** screen.

Continued

## Wallpaper Setup

You can change, store, and delete the wallpaper on the audio/information screen.

### Import wallpaper

You can import up to five images, one at a time, for wallpaper from a USB flash drive.

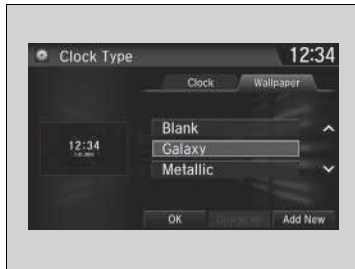

1. Connect the USB flash drive to the USB port.

➤ **USB Port(s)** P. 285

2. Select **Settings**.
3. Select **Clock**.
4. Select **Clock/Wallpaper Type**, then open the **Wallpaper** tab.
5. Select **Add New**.

▶ The picture name is displayed on the list.

6. Select a desired picture.

▶ The preview is displayed on the left side on the screen.

7. Select **Start Import** to save the data.

▶ The display will return to the wallpaper list.



### Wallpaper Setup

The wallpaper you set up on **Clock/Wallpaper Type** cannot be displayed on the driver information interface.

- When importing wallpaper files, the image must be in the USB flash drive's root directory. Images in a folder cannot be imported.
- The file name must be fewer than 64 characters.
- The file format of the image that can be imported is BMP (bmp) or JPEG (jpg).
- The individual file size limit is 5 MB.
- The maximum image size is 4,096 × 4,096 pixels. If the image size is less than 800 × 480 pixels, the image is displayed in the middle of the screen with the extra area appearing in black.
- If the USB flash drive does not have any pictures, the **No files detected.** message appears.

After changing the screen interface design, you can change the wallpaper by following procedure.

1. Press the  button.
2. Select and hold empty space on the home screen. The pop-up menu appears on the screen.
3. Select **Change wallpaper**.
4. Select **Gallery**, **Live wallpapers**, or **Wallpapers**.

### ■ Select wallpaper

1. Select **Settings**.
2. Select **Clock**.
3. Select **Clock/Wallpaper Type**, then open the **Wallpaper** tab.
  - ▶ The screen changes to the wallpaper list.
4. Select a desired wallpaper.
  - ▶ The preview is displayed on the left side on the screen.
  - ▶ The pop-up menu appears on the screen.
5. Select **Set**.
  - ▶ The display will return to the wallpaper list.

### ■ To view wallpaper once it is set

1. Press the  button.
2. Select **Info**.
3. Select **MENU**.
4. Select **Clock/wallpaper**.

### ■ Delete wallpaper

1. Select **Settings**.
2. Select **Clock**.
3. Select **Clock/Wallpaper Type**, then open the **Wallpaper** tab.
  - ▶ The screen changes to the wallpaper list.
4. Select a wallpaper that you want to delete.
  - ▶ The preview is displayed on the left side on the screen.
  - ▶ The pop-up menu appears on the screen.
5. Select **Delete**.
  - ▶ A confirmation message appears on the screen.
6. Select **Yes** to delete completely.
  - ▶ The display will return to the wallpaper list.

### ▣ Wallpaper Setup

From the pop-up menu, select **Preview** to see a preview at full-size screen.



To go back to the previous screen, select **OK**, or press the  button.



When the file size is large, it takes a while to be previewed.

To delete all wallpapers you add, select **Delete All**, then **Yes**.

## Home Screen

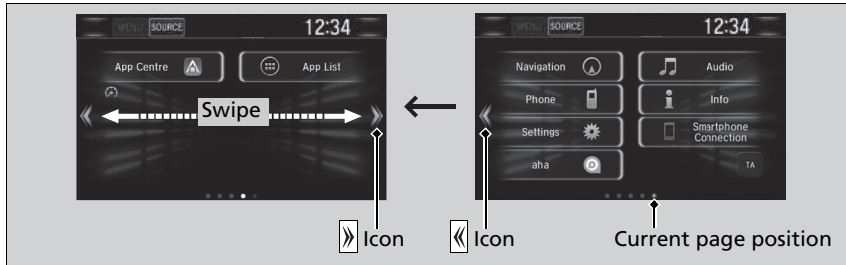
### ■ To change to a next screen



Selecting  or , or swiping the screen left or right changes to the next screen.



## Home Screen

The home screen has 5 pages (fixed). You cannot add any more pages.



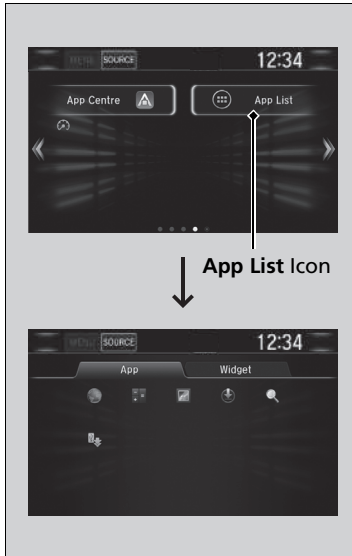



Press the  button to go directly back to the first page of the home screen from any page.

## ■ To use apps or widgets



1. Press the  button.
2. Select **App List** .
- ▶ The apps screen appears.
3. Select the app or widget you want to use.

### Preinstall app list:

-  (Browser): Displays the web browser utilized by smartphone and Wi-Fi connection.
-  (Calculator): Displays Calculator.
-  (Gallery): Displays images.
-  (Downloads): Displays the data downloaded from the web browser and so on.
-  (Search): Displays various retrieval screen.
-  (App installer): Check with a Honda dealer for apps that are available for installation.

### ▶▶ To use apps or widgets

Select and hold a selected app or widget to add that app's or widget's shortcut on the home screen.

Pre-installed apps may not start up normally. If this occurs, you need to reset the system.

#### ▶ **Defaulting All the Settings** P. 429

If you perform **Factory Data Reset**, it may reset all the settings to their factory default.

#### ▶ **Defaulting All the Settings** P. 429

In case those apps still do not startup normally even after **Factory Data Reset**, contact your dealer.

There is a possibility that a browser is shut down in the situation of the use. In that situation, the screen will return to before the browser startup.

Do not install apps other than those confirmed by a Honda dealer. Installation of unauthorized apps may introduce data corruption risks to your vehicle's information and your privacy.

You can delete user installed apps by the following procedure.

1. Press the  button.
2. Select **Settings**.
3. Select **System**.
4. Select the **Others** tab.
5. Select **Detailed Information**.
6. Select **Apps**.
7. Select an app that you want to delete.
8. Select **Delete**.

Pre-installed apps cannot be deleted.

Continued

### ■ To add app or widget icons on the home screen

App or widget icons can be added on the home screen.

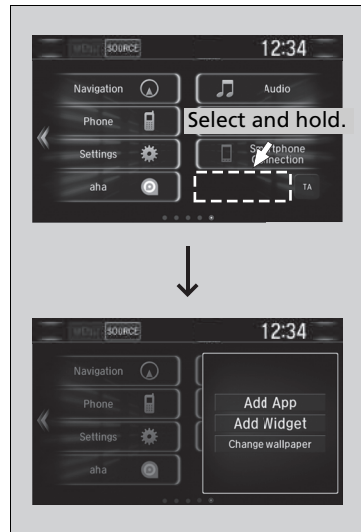

1. Press the  button.
2. Select and hold empty space on the home screen.
  - ▶ The pop-up menu appears on the screen.

3. Select **Add App** or **Add Widget**.
  - ▶ The apps screen appears.



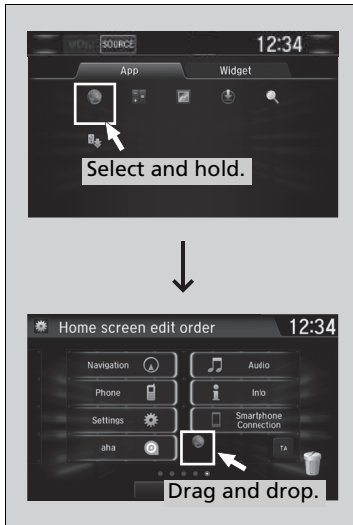

4. Select and hold an app or widget icon you want to add.
  - ▶ The screen switches to the customization screen.
5. Drag and drop the icon to where you want it to be.
6. Select **OK**.
  - ▶ The screen will return to the home screen.

### ■ To move icons on the home screen

You can change location on the home screen.

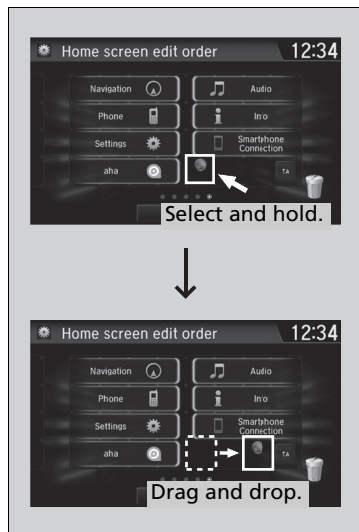

1. Select and hold an icon.
  - ▶ The screen switches to the customization screen.
2. Drag and drop the icon to where you want it to be.
3. Select **OK**.
  - ▶ The screen will return to the home screen.

### ☒ To move icons on the home screen

You can also move the **Phone, Info, Audio, Settings, Navigation\***, **Smartphone Connection, aha\***, **App Centre\***, **TA\***, **App List** (☺), and (🔄) (instrument panel) icons in the same manner.

### ■ To remove icons on the home screen

You can delete the icons on the home screen.

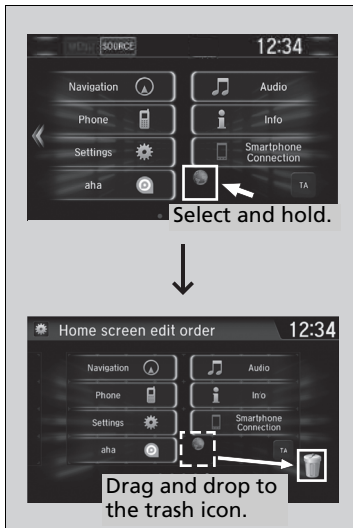

1. Select and hold an icon.
  - ▶ The screen switches to the customization screen.
2. Drag and drop the icon you want to remove to the trash icon.
  - ▶ The icon is removed from the home screen.
3. Select **OK**.
  - ▶ The screen will return to the home screen.

### ▣ To remove icons on the home screen

You cannot delete the **Phone**, **Info**, **Audio**, **Settings**, **Navigation**\*, **Smartphone Connection**, **aha**\*, **App Centre**\*, **TA**\*, **App List** (☺), and (🔧) (instrument panel) icons.

Deleting an app or widget from the home screen does not delete the app or widget itself.

\* Not available on all models

Continued

### ■ To change the home screen wallpaper

You can change a wallpaper of the home screen.

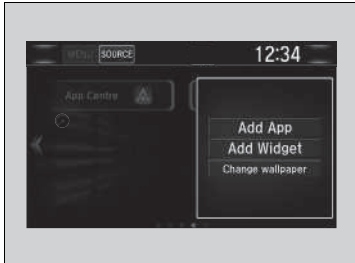



1. Select and hold empty space on the home screen.
  - ▶ The pop-up menu appears on the screen.
2. Select **Change wallpaper**.
  - ▶ The pop-up menu appears on the screen.

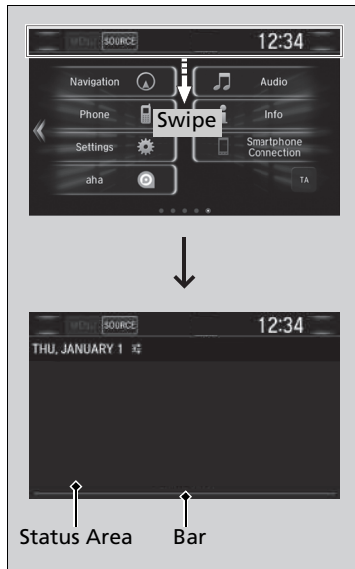

3. Select an app for selecting wallpapers.
4. Select your desired wallpaper.
5. Select **Set wallpaper**.
  - ▶ The wallpaper is changed, then the screen will return to the home screen.

## Status Area



1. Swipe down from the top of the screen.  
▶ The status area appears.
2. Select an item to see the details.
3. Press the  button or swipe up from the bottom bar to close the area.

## Changing the Screen Interface

You can change the screen interface design.



1. Press the  button.
2. Select **Settings**.
3. Select **System**.
4. Select the **Others** tab.
5. Select **Change Skin**.
6. A confirmation message appears on the screen. Select **Yes**.

## Changing the Screen Interface

After changing the screen interface design, you can change the wallpaper by following procedure.

1. Press the  button.
2. Select and hold empty space on the home screen. The pop-up menu appears on the screen.
3. Select **Change wallpaper**.
4. Select **Gallery**, **Live wallpapers**, or **Wallpapers**.

If you change the screen interface, some of the setting items will change.

➤ **Customized Features** P. 396

## ■ Menu Customize

You can change menu icons on the right side of the **Audio**, **Phone**, and **Info** screen.

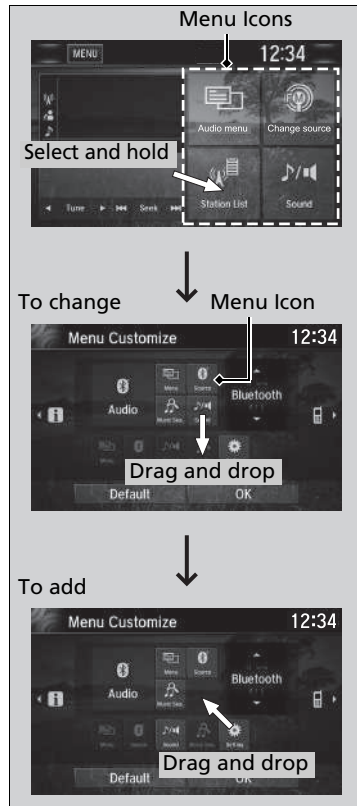

1. Select and hold menu icon.

2. Select ◀ or ▶ icon, then **Audio**, **Phone**, or **Info** from **Menu Customize**.

3. Select and hold the menu icon you want to change, then drag and drop the icon to the bottom.

4. Select and hold the menu icon you want to add, then drag and drop the icon to above.

5. Select **OK**.

## ▣ Menu Customize

You can also use the method below to change menu icon:

Select **Settings**→**System**→**Home tab**→**Menu Icon Position**

## Closing Apps

You can close specific apps running in the background on the system.

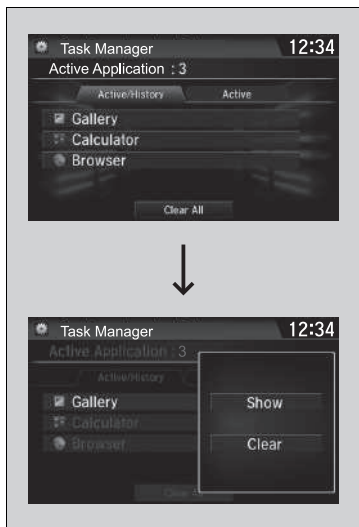

1. Press and hold the  button.
2. Select the **Active** tab.
  - ▶ If you select the **Active/History** tab, you can close the apps that are currently running and delete the app activity history simultaneously.
3. Select an app you want to close.
4. Select **Clear**.
  - ▶ The display will return to the app list.

## Closing Apps

If you have a number of apps running in the background and something goes wrong with the audio system, some of those apps may not work properly. If this happens, close all the apps and re-launch the app/apps that you want to use.

To close all apps on the system, select **Clear All**, then **Yes**.

You cannot close the Aha™\* and Garmin\* apps.



## Adjusting the Sound



1. Press the  button.
2. Select **MENU**.
3. Select **Sound**.

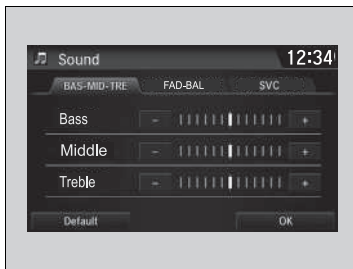

Select a tab from the following choices:

- **BAS-MID-TRE**: Bass, Middle, Treble
- **FAD-BAL\*/FAD-BAL-SUBW\***: Fader, Balance, Subwoofer\*
- **SVC\*/SVC-Neural\***: Speed Volume Compensation, DTS Neural Surround™\*

### ▶▶ Adjusting the Sound

The SVC has four modes: **Off**, **Low**, **Mid**, and **High**. SVC adjusts the volume level based on the vehicle speed. As you go faster, audio volume increases. As you slow down, audio volume decreases.

You can also turn on and off the DTS Neural Surround™ setting\* by selecting **Neural** on the audio/information screen.

\* Not available on all models

## Display Setup

You can change the brightness or colour theme of the audio/information screen.

### Changing the Screen Brightness

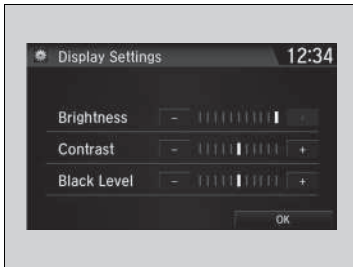

1. Press the  button.
2. Select **Settings**.
3. Select **System**.
4. Select the **Display** tab.
5. Select **Display Settings**.
6. Select the setting you want.
7. Select **OK**.

### Changing the Screen's Colour Theme



1. Press the  button.
2. Select **Settings**.
3. Select **System**.
4. Select the **Display** tab.
5. Select **Background Colour**.
6. Select the setting you want.
7. Select **OK**.

#### Changing the Screen Brightness

You can change the **Contrast** and **Black Level** settings in the same manner.

#### Changing the Screen's Colour Theme

You cannot change the **Background Colour** if you change the screen interface design.

## ■ Selecting an Audio Source

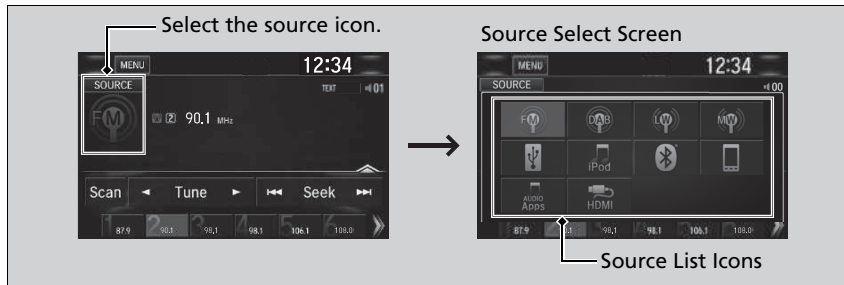



Select the current source icon, then select an icon on the source list to switch the audio source.

## ■ Limitations for Manual Operation

Certain manual functions are disabled or inoperable while the vehicle is in motion. You cannot select a grayed-out option until the vehicle is stopped.

Models with navigation system and DAB

## Voice Control Operation\*1

Your vehicle has a voice control system that allows hands-free operation. The voice control system uses the  (Talk) and  (hang-up/back) buttons on the steering wheel and a microphone near the map lights in the ceiling.

### Voice Recognition



To achieve optimum voice recognition when using the voice control system:

- Make sure the correct screen is displayed for the voice command that you are using.  
The system recognizes only certain commands.  
Available voice command P. 341
- Close the windows and sunroof\*.
- Adjust the dashboard and side vents so air does not blow onto the microphone in the ceiling.
- Speak clearly in a natural speaking voice without pausing between words.
- Reduce any background noise if possible. The system may misinterpret your command if more than one person is speaking at the same time.

\*1: Language that the voice control system recognizes are English, German, French, Spanish, and Italian.

\* Not available on all models

### ☒ Voice Control Operation\*1

When you press the  button, a helpful prompt asks what you would like to do. Press and release the  button again to bypass this prompt and give a command.

### ☒ Voice Recognition

The voice control system can only be used from the driver's seat because the microphone unit removes noises from the front passenger's side.

## ■ Voice Portal Screen\*

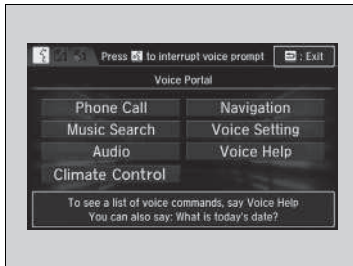

When the  (Talk) button is pressed, available voice commands appear on the screen.

For a complete list of commands, say "Voice Help" after the beep or select **Voice Help**.

You can see the list of commands in **Voice Info** on the **Info Menu** screen. Select **Info**, then select **MENU**.

The system only recognizes the commands on the following pages, at certain screens. Free form voice commands are not recognized.

### ■ Phone Call

This can be only used when the phone is connected. When the system recognizes the *Phone call* command, the screen will change to the voice recognition screen for phone commands.

- *Dial by Number*
- *Call History*
- *Redial*
- *Call <Your contact Name>*
- *Call <Phone Number>*

Phone Call commands are not available if using Apple CarPlay.

### ■ Music Search

This can be only used when the iPod or USB device is connected.

### ■ Climate Control

When the system recognizes the *Climate Control* command, the screen will change the dedicated screen to the climate control voice recognition screen.

- ▶ **Climate Control Commands** P. 343

### ■ Audio

When the system recognizes the *Audio* command, the screen will change to the audio voice recognition screen.

- *Audio On*\*1
- *Audio Off*\*1
- *Radio FM*
- *Radio MW*
- *Radio LW*
- *iPod*
- *USB*
- *Other Sources*

### ■ Navigation

The screen changes to the navigation screen.

- ▶ **Refer to the Navigation System Manual**

### ■ Voice Setting

The screen changes to the **Voice Recog.** tab on the **System Settings** screen.

\*1: These commands toggle the function on and off, so the command may not match your intended action.

\* Not available on all models

### ■ Voice Help

You can see a list of the available commands on the screen.

- *Useful Commands*
- *Phone Commands*
- *Audio Commands*
- *On Screen Commands*
- *Music Search Commands*
- *General Commands*
- *Climate Control Commands*

### ■ Useful Commands

The system accepts these commands on the voice portal top screen.

- *Call <Phone Number>*
- *Call <Your contact Name>*
- *What time is it?*
- *What is today's date?*

### ■ Phone Commands

The system accepts these commands on the dedicated screen for the voice recognition of the phone.

- *Call by number*
- *Call by name*
- *Call <Phone Number>*
- *Call <Your contact Name>*

### ■ Audio Commands

The system accepts these commands on the dedicated screen for the voice recognition of the audio.

#### ■ Radio FM Commands

- *Radio tune to <87.5-108.0> FM*
- *Radio FM preset <1-12>*

#### ■ Radio LW Commands

- *Radio tune to <153-279> LW*
- *Radio LW preset <1-6>*

#### ■ Radio MW Commands

- *Radio tune to <531-1602> MW*
- *Radio MW preset <1-6>*

#### ■ iPod Commands

- *iPod play*

- *iPod play track <1-30>*
- *Music Search*
- *What album is this?*
- *What am I listening to?*

#### ■ USB Commands

- *USB play*
- *USB play track <1-30>*
- *Music Search*
- *What album is this?*
- *What am I listening to?*

#### ■ DAB Commands

- *DAB preset <1-12>*

#### ■ Bluetooth® audio Commands

- *Bluetooth® audio play*

#### NOTE:

*Bluetooth®* Audio commands may not work on some phones or *Bluetooth®* Audio devices.

#### ■ HDMI™ Commands

- *HDMI Play*

### ■ On Screen Commands

When **On Screen Commands** is selected, the explanation screen is displayed.

### ■ Music Search Commands

The system accepts these commands on the **Music Search** screen.

#### ■ Using Song By Voice

Song By Voice™ is a feature that allows you to select music from your iPod or USB device using Voice Commands. To activate this mode, you must push the talk switch and say: "Music Search".

#### ■ Song By Voice Commands

- *What am I listening to?*
- *Who am I listening to?*
- *Who is this?*
- *What's playing?*
- *Who's playing?*
- *What album is this?*

### ■ Play Commands

- *Play artist <Name>*
- *Play track/song <Name>*
- *Play album <Name>*
- *Play genre/category <Name>*
- *Play playlist <Name>*
- *Play composer <Name>*

### ■ List Commands

- *List artist <Name>*
- *List album <Name>*
- *List genre/category <Name>*
- *List playlist <Name>*
- *List composer <Name>*

### ■ General Commands

- *What time is it?*
- *What is today's date?*

### ■ Climate Control Commands

- *Climate control on\*1*
- *Climate control off\*1*
- *Fan speed <1-7>*
- *Temperature max heat*
- *Temperature max cool*
- *Temperature <15-29> degrees*
- *Defrost On\*1*
- *Defrost Off\*1*
- *Air Conditioner On\*1*
- *Air Conditioner Off\*1*
- *More*
- *Climate Control Automatic*
- *Vent*
- *Dash and floor*
- *Fan speed Up*
- *Fan speed Down*
- *Floor vents*
- *Floor and Defrost*
- *Temperature up*
- *Temperature down*

\*1: These commands toggle the function on and off, so the command may not match your intended action.

## Playing AM/FM Radio

The diagram illustrates the car's audio system interface. At the top, the **Driver Information Interface** displays a speedometer showing 40 km/h, a radio frequency of 90.1 MHz, and other vehicle information like temperature (23°C), distance (123.4 km), and time (12:34). Below it, the **Audio/Information Screen** shows the radio source (FM 90.1 MHz), a time display (12:34), and various control buttons: **Scan**, **Tune**, and **Seek**. A list of preset frequencies (87.9, 90.1, 98.1, 98.1, 106.1, 108.0) is visible at the bottom of the screen. To the left of the screen is a vertical menu with options: HOME, MAP, AUDIO, TEL, BACK, VOL, and AUDIO. A physical **VOL/AUDIO (Volume/Power Audio) Knob** is located below the menu. The diagram also shows **Seek Icons** (left and right arrows) and **Open/Close Icon** (a square with a vertical line) on the screen.

**MENU**  
Select to display the menu items.

**(Audio) Button**  
Press to display the audio screen.

**(Back) Button**  
Press to go back to the previous display.

**VOL/AUDIO (Volume/Power Audio) Knob**  
Press to turn the audio system on and off. Turn to adjust the volume.

**Scan Icon**  
Select to scan each station with a strong signal.

**Driver Information Interface**

**Audio/Information Screen**

**Seek Icons**  
Select **▶▶** or **◀◀** to search the selected band up or down for a station with a strong signal.

**Open/Close Icon\*1**  
Displays/hides the detailed information.

**Preset Icons**  
Tune the preset radio frequency. Select and hold the preset icon to store that station. Select **>>** to display preset 7 onwards.

**Tune Icons**  
Select **◀** or **▶** to tune the radio frequency.

\*1: Some or all of the lists may not be displayed.



## ■ Preset Memory

To store a station:

1. Tune to the selected station.
2. Select and hold the preset number for the station you want to store.

You can also store a preset station by the following procedure.

1. Tune to the selected station.
2. Select the open/close icon to display a list.
3. Select the **Preset** tab.
4. Select and hold the preset number for the station you want to store.

## ■ Station List

Lists the strongest stations on the selected band.

1. Select the open/close icon to display a list.
2. Select the **Station List** tab.
3. Select the station.

## ■ Manual update



Updates your available station list at any time.

1. Select the open/close icon to display a list.
2. Select the **Station List** tab.
3. Select **Refresh**.

## ▶▶ Playing AM/FM Radio

The **ST** indicator appears on the display indicating stereo FM broadcasts.  
Stereo reproduction in AM is not available.

Switching the Audio Mode

Press the  or  button on the steering wheel or select **SOURCE** on the screen.

 **Audio Remote Controls** P. 288

### Models without LaneWatch

You can store 12 AM stations and 12 FM stations into preset memory. AM has two types of frequencies LW and MW, and each lets you store six stations.

### Models with LaneWatch

You can store 6 AM stations and 12 FM stations into preset memory.

## ■ Scan

Samples each of the strongest stations on the selected band for 10 seconds. To turn off scan, select **Cancel** or press the  button.

## ■ Radio Data System (RDS)

Provides text data information related to your selected RDS-capable FM station.

### ■ To find an RDS station from Station List

1. Select the open/close icon to display a list while listening to an FM station.
2. Select the **Station List** tab.
3. Select the station.

### ■ Manual update

Updates your available station list at any time.

1. Select the open/close icon to display a list while listening to an FM station.
2. Select the **Station List** tab.
3. Select **Refresh**.

### ■ Radio text

Displays the radio text information of the selected RDS station.

1. Select **MENU**.
2. Select **View Radio Text**.

### ☒ Radio Data System (RDS)

When you select an RDS-capable FM station, the RDS automatically turns on, and the frequency display changes to the station name. However, when the signals of that station become weak, the display changes from the station name to the frequency.

## Playing DAB (Digital Audio Broadcasting)\*

**Driver Information Interface**

**Audio/Information Screen**

**MENU**  
Select to display the menu items.

**(Audio) Button**  
Press to display the audio screen.

**(Back) Button**  
Press to go back to the previous display.

**VOL/AUDIO (Volume/Power Audio) Knob**  
Press to turn the audio system on and off. Turn to adjust the volume.

**Scan Icon**  
Select to scan each receivable ensemble or service.

**Service Icons**  
Select **◀◀** or **▶▶** to tune the service component.

**Open/Close Icon\*1**  
Displays/hides the detailed information.

**Preset Icons**  
Tune the preset frequency. Select and hold the preset icon to store that station. Select **>>** to display preset 7 onwards.

**Ensemble Icons**  
Select **◀** or **▶** to tune the ensemble.  
Select and hold **◀** or **▶** to search the selected service up to down for an ensemble until an receivable ensemble is found.

\*1:Some or all of the lists may not be displayed.

\* Not available on all models

## ■ Preset Memory

To store a service:

1. Tune to the selected service.
2. Select and hold the preset number for the service you want to store.

You can also store a preset service by the following procedure.

1. Tune to the selected service.
2. Select the open/close icon to display a list.
3. Select the **Preset** tab.
4. Select and hold the preset number for the service you want to store.

## ■ Ensemble List

Lists the receivable ensembles on the selected service.

1. Select the open/close icon to display a list.
2. Select the **Ensemble List** tab.
3. Select the ensemble.

### ■ Manual update

Updates your available ensemble list at any time.

1. Select the open/close icon to display a list.
2. Select the **Ensemble List** tab.
3. Select **Refresh**.

## ☒ Preset Memory

Switching the Audio Mode

Press the ▲ or ▼ button on the steering wheel or select **SOURCE** on the screen.

☒ **Audio Remote Controls** P. 288

You can store 12 DAB stations into preset memory.

## ■ Scan

Samples each of the receivable ensemble or service on the selected service for 10 seconds.

1. Select **Scan**.
2. Select **Scan Ensemble** or **Scan All Service**.

To turn off scan, select **Cancel** or press the  button.

## ■ Radio Text

Displays the radio text information of the selected DAB station.

1. Select **MENU**.
2. Select **View Radio Text**.

## Playing an iPod

Connect the iPod using your USB connector to the USB port, then select the iPod mode.

📌 **USB Port(s)** P. 285

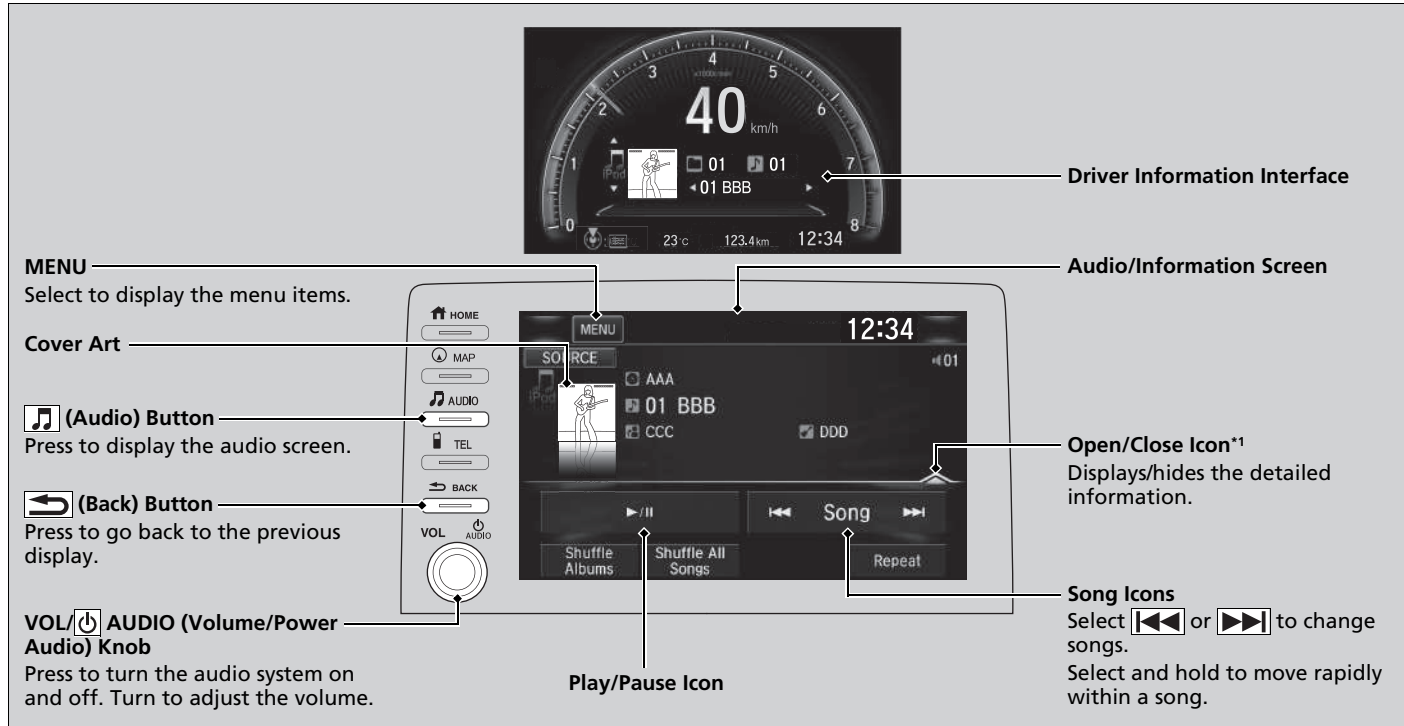

\*1: Some or all of the lists may not be displayed.

## How to Select a Song from the Music Search List

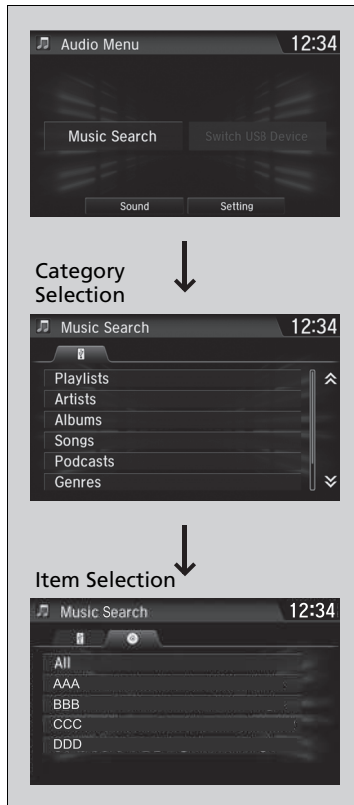

1. Select **MENU** and select **Music Search**.

2. Select the items on that menu.

## ▶▶▶ Playing an iPod

Available operating functions vary on models or versions. Some functions may not be available on the vehicle's audio system.

If there is a problem, you may see an error message on the audio/information screen.

▶▶▶ **iPod/USB Flash Drive** P. 380

If you operate any music app on your iPhone/iPod while the phone is connected to the audio system, you may no longer be able to operate the same app on the audio/information screen. Reconnect the device if necessary.

## ■ How to Select a Play Mode

You can select shuffle and repeat modes when playing a song.  
Select a play mode.



### ■ To turn off a play mode

Select the mode you want to turn off.

## ☒ How to Select a Play Mode

Play Mode Menu Items

**Shuffle Albums**\*1: Plays all available albums in a selected list in random order.

**Shuffle All Songs/Shuffle**: Plays all available songs in a selected list in random order.

**Repeat**: Repeats the song.

\* 1: This function is not available if your iPod is not supported.



## Song By Voice™ (SBV)\*

Use SBV to search for and play music from your USB flash drive or iPod using voice commands.

### ■ To enable SBV

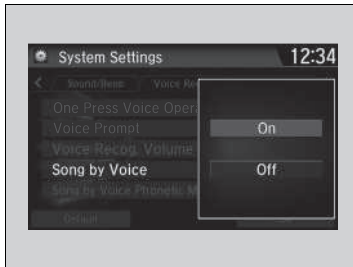

1. Press the  button.
2. Select **Settings**.
3. Select **System**.
4. Select the **Voice Recog.** tab.
5. Select **Song by Voice**.
6. Select **On** or **Off**.

### ☒ Song By Voice™ (SBV)\*



Setting options:

- **On** (factory default): Song By Voice™ commands are available.
- **Off**: Disable the feature.

\* Not available on all models

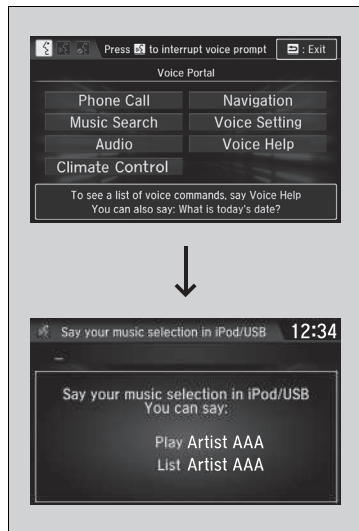
## ■ Searching for music using SBV



1. Set the **Song by Voice** setting to **On**.
2. Press the  (Talk) button and say *"Music Search"* to activate the SBV feature for the USB flash drive and iPod.
3. Then, say a next command.
  - ▶ Example 1: Say *"(List) 'Artist A'"* to view a list of songs by that artist. Select the desired song to start playing.
  - ▶ Example 2: Say *"Play 'Artist A'"* to start playing songs by that artist.
4. To cancel SBV, press the  (hang-up/back) button on the steering wheel. The selected song continues playing.

Once you have cancelled this mode, you need to press the  button and say *"Music Search"* again to re-activate this mode.

## ☒ Searching for music using SBV

Song By Voice™ Commands List

▶ **Song By Voice Commands** P. 343

NOTE:

Song By Voice™ commands are available for files or songs stored on the USB flash drive or iPod.

You can add phonetic modifications of difficult words so that it is easier for SBV to recognize artists, songs, albums, and composers in voice commands.

▶ **Phonetic Modification** P. 355

## ■ Phonetic Modification

Add phonetic modifications of difficult or foreign words so that it is easier for SBV to recognize artists, songs, albums, and composers in voice commands when searching for music on the USB flash drive or iPod.





1. Press the  button.
2. Select **Settings**.
3. Select **System**.
4. Select the **Voice Recog.** tab.
5. Select **Song by Voice Phonetic Modification**.
6. Select **New Modification**.
7. Select **USB** or **iPod**.

### ☒ Phonetic Modification

**Song by Voice Phonetic Modification** function is not available when **Song by Voice** is set to **Off**.

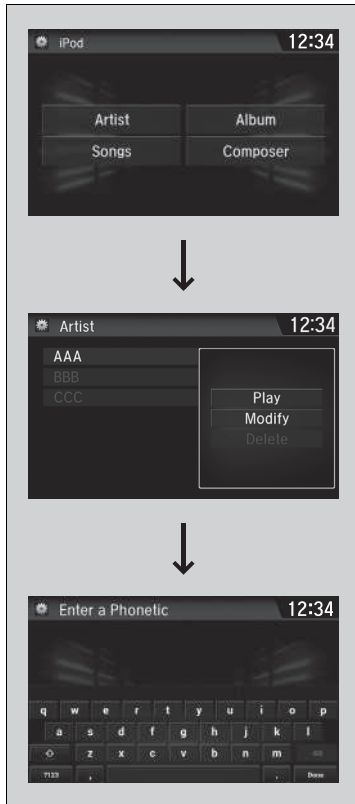
You can store up to 2,000 phonetic modification items.



8. Select the item to modify (e.g., **Artist**).
  - ▶ The list of the selected item appears on the screen.
9. Select an entry to modify.
  - ▶ The pop-up menu appears on the screen.
  - ▶ To listen to the current phonetic modification, select **Play**.
  - ▶ To delete the current phonetic modification, select **Delete**.
10. Select **Modify**.
11. Select the phonetic spelling you want to use (e.g., "Artist A") when prompted.
12. Select **OK**.
  - ▶ The artist "No Name" is phonetically modified to "Artist A." When in the SBV mode, you can press the  (Talk) button and use the voice command "Play 'Artist A'" to play songs by the artist "No Name."

## Playing Aha™\*

Aha™ can be displayed and operated on the audio/information screen when your smartphone is connected to the audio system by Wi-Fi.

▶ **Wi-Fi Connection** P. 370

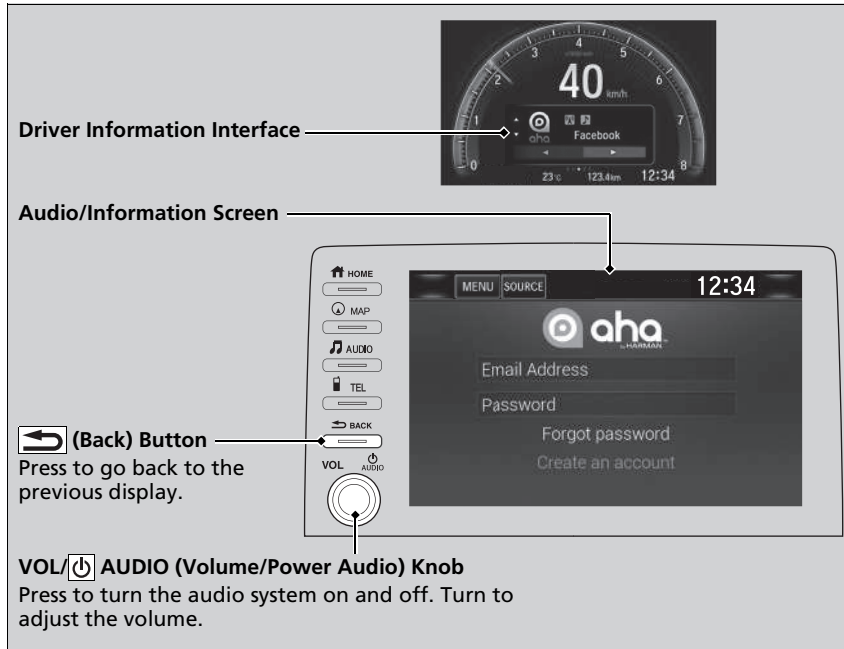

### ▶▶ Playing Aha™\*

Aha™ by Harman is a cloud-based service that organizes your favorite web content into live radio stations. You can access podcasts, internet radio, location-based services, and audio updates from social media sites.

Available operating functions vary on software versions. Some functions may not be available on the vehicle's audio system.

The menu items vary depending on the station you selected.

You must have a previously set up Aha™ account prior to using the service in your vehicle. Visit [www.aharadio.com](http://www.aharadio.com) for more information.

You want to select another source, select **SOURCE** on the upper left of the screen. The source select screen will appear. Select the source you want.

If there is an active connection to Apple CarPlay or Android Auto, Aha™ can only be accessed when the phone is connected through Wi-Fi.

\* Not available on all models

## Playing a USB Flash Drive

Your audio system reads and plays sound and videos files on a USB flash drive in either MP3, WMA, AAC\*1, WAV, or MP4 format.

Connect your USB flash drive to the USB port, then select the USB mode.

📍 **USB Port(s)** P. 285

**Driver Information Interface**

**Audio/Information Screen**

**MENU**  
Select to display the menu items.

**(Audio) Button**  
Press to display the audio screen.

**(Back) Button**  
Press to go back to the previous display.

**VOL/AUDIO (Volume/Power Audio) Knob**  
Press to turn the audio system on and off. Turn to adjust the volume.

**Track Icons**  
Select **⏮** or **⏭** to change files.  
Select and hold to move rapidly within a file.

**Open/Close Icon\*2**  
Displays/hides the detailed information.

**Folder Icons**  
Select **▶** to skip to the next folder, and **◀** to skip to the beginning of the previous folder.

\*1: Only AAC format files recorded with iTunes are playable on this unit.

\*2: Some or all of the lists may not be displayed.

## How to Select a File from the Music Search List

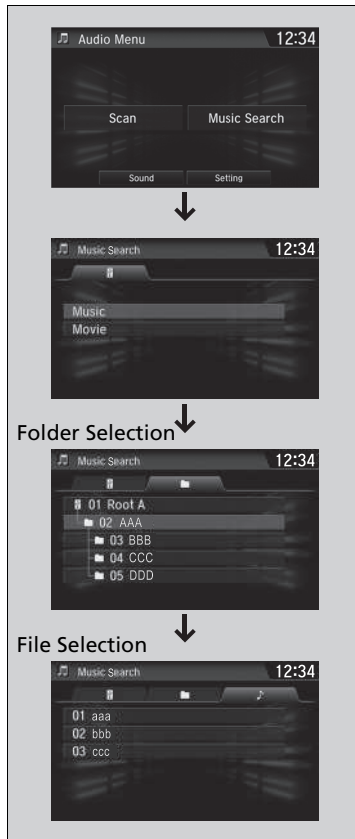

1. Select **MENU** and select **Music Search**.

2. Select **Music** or **Movie**.

3. Select a folder.

4. Select a file.

## ▶▶ Playing a USB Flash Drive

Use the recommended USB flash drives.

▶ **General Information on the Audio System**  
P. 382

WMA files protected by digital rights management (DRM) cannot be played.

The audio system displays **Unplayable File**, then skips to the next file.

If there is a problem, you may see an error message on the audio/information screen.

▶ **iPod/USB Flash Drive** P. 380

Continued

## How to Select a Play Mode

You can select scan, repeat, and random modes when playing a file.

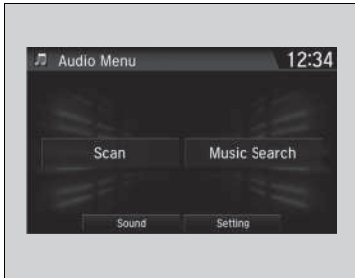

### ■ Scan

1. Select **MENU**.
2. Select **Scan**.
3. Select a play mode.

### ■ Random/Repeat

Select a play mode.

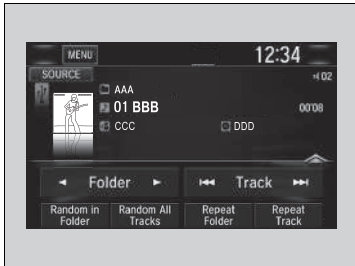

### ■ To turn off a play mode

To turn off Scan, press the  button or select **Cancel**.

To turn off random or repeat, select the mode again.

## How to Select a Play Mode

Play Mode Menu Items

### Scan

**Scan Folders:** Provides 10-second sampling of the first file in each of the main folders.

**Scan Tracks:** Provides 10-second sampling of all files in the current folder.

### Random/Repeat

**Random in Folder:** Plays all files in the current folder in random order.

**Random All Tracks:** Plays all files in random order.

**Repeat Folder:** Repeats all files in the current folder.

**Repeat Track:** Repeats the current file.

When playing a video file:

**Play/Pause:** Plays or pauses the file.

**Stop:** Stops the file.



## Playing *Bluetooth*® Audio

Your audio system allows you to listen to music from your *Bluetooth*-compatible phone.

This function is available when the phone is paired and connected to the vehicle's Hands-Free Telephone (HFT) system.

▶ **Phone Setup** P. 459

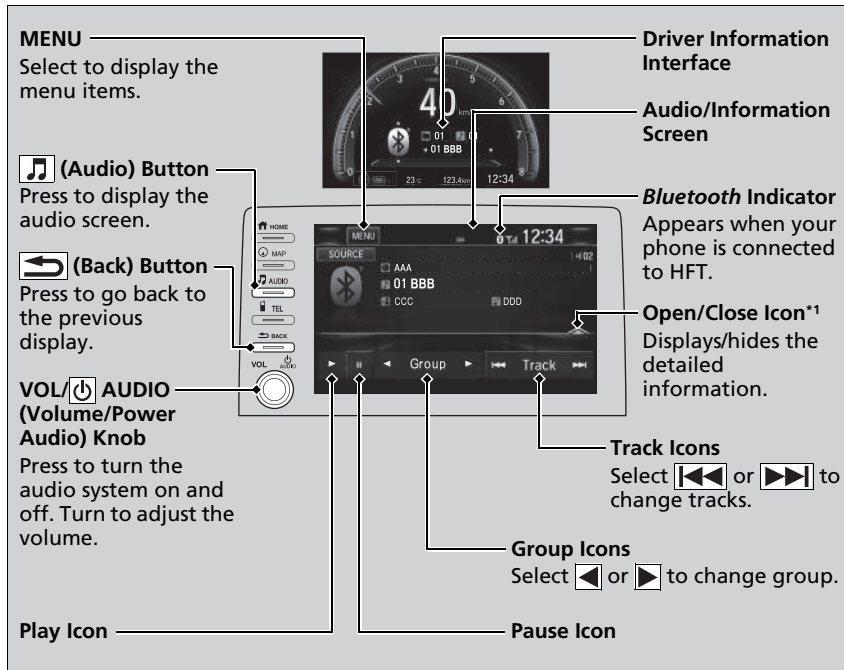

\*1: Depending on the *Bluetooth*® device you connect, some or all of the lists may not be displayed.

### ▶▶ Playing *Bluetooth*® Audio

Not all *Bluetooth*-enabled phones with streaming audio capabilities are compatible.

To check if your phone is compatible, ask a dealer.

It may be illegal to perform some data device functions while driving.

Only one phone can be used with HFT at a time. When there are more than two paired phones in the vehicle, the system automatically connects to the prioritized phone. You can assign priority to a phone in the **Priority Device Settings**.

▶ **Customized Features** P. 396

The connected phone for *Bluetooth*® Audio can be different.

If more than one phone is paired to the HFT system, there may be a delay before the system begins to play.

In some cases, the name of the artist, album, or track may not appear correctly. Some functions may not be available on some devices.

If a phone is currently connected via Apple CarPlay or Android Auto, *Bluetooth*® Audio from that phone is unavailable. However, a second previously paired phone can stream *Bluetooth*® Audio by selecting **Connect** [🎵] from the **Bluetooth Device List** screen.

▶ **Phone Setup** P. 459

Continued

## To Play *Bluetooth*® Audio Files

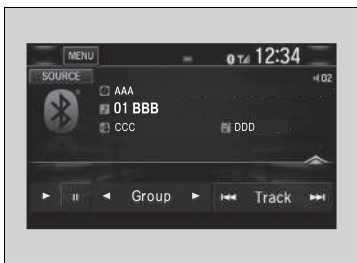

1. Make sure that your phone is paired and connected to the system.

➤ **Phone Setup** P. 459

2. Select the *Bluetooth*® Audio mode.

If the phone is not recognised, another HFT-compatible phone, which is not compatible for *Bluetooth*® Audio, may already be connected.

### ■ To pause or resume a file

Select the play icon or pause icon.

## Searching for Music

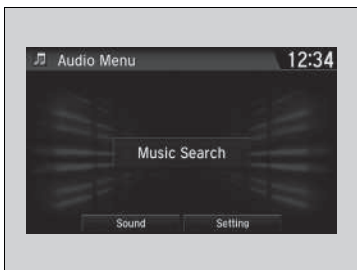

1. Select **MENU**.
2. Select **Music Search**.
3. Select a search category (e.g., Albums).
4. Select an item.
  - ▶ The selection begins playing.

## ☒ To Play *Bluetooth*® Audio Files

To play the audio files, you may need to operate your phone. If so, follow the phone maker's operating instructions.

Switching to another mode pauses the music playing from your phone.

You can change the connected phone in the *Bluetooth*® settings on the **Audio Menu** screen by the following procedure.

1. Select **MENU**.
2. Select **Setting**.

## ☒ Searching for Music

Depending on the *Bluetooth*® device you connect, some or all of the lists may not be displayed.

## Playing a Video Using the HDMI™

Your audio system allows you to play videos from an HDMI-compatible device. Connect the device, using an HDMI™ cable, then select the HDMI™ mode.

📖 **HDMI™ Port**\* P. 287

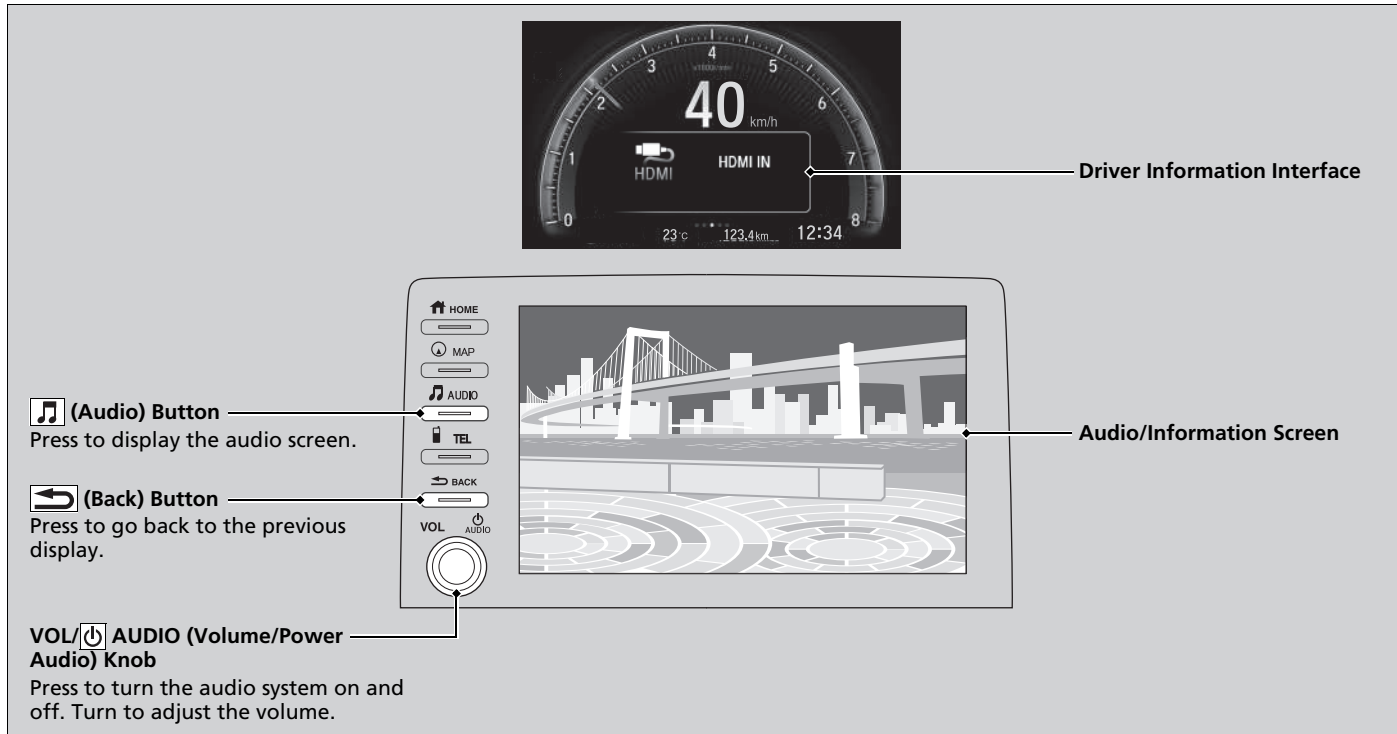

\* Not available on all models

## ■ Changing the Screen Aspect



1. Press the  button.
2. Select **Settings**.
3. Select **Audio**.
4. Select the **Video** tab.
5. Select **Aspect Ratio Adjustment**.
6. Select the setting you want.
7. Select **OK**.

## ▶▶ Playing a Video Using the HDMI™

This feature is limited while driving. To play videos, stop your vehicle and apply the parking brake.

## On Board Apps\*

Honda Connect has the capability of On Board Apps which may be created by Honda or by 3rd parties. Apps may be already installed or can be downloaded through Honda App Center. Some Apps require internet access which can be established by Wi-Fi Connection.

➤ **Wi-Fi Connection** P. 370

Please visit the below web address for further information:

<https://ivhs.os.ixonos.com/honda/category/carApps.html>

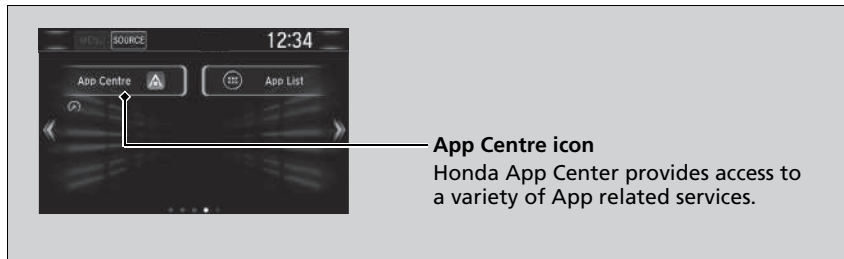

### ▶▶ On Board Apps\*

Even if you change **Background Colour** on the **System Settings** screen, it will not be reflected on the Honda App Center screen.

- Using the Display Audio system while driving can take your attention away from the road, causing a crash in which you could be seriously injured or killed. Only operate system controls when the conditions permit you to safely do so. **Please always adhere to the laws of the territory when operating this device.**
- Applications on the head unit are subject to change at anytime. This may mean that they are not available or operate differently. Honda shall not be liable to you in such instances.
- Applications available on the device may be provided by parties other than Honda to which 3rd party software licences and charges may apply.
- Data usage and roaming charges may result in using applications on the device in conjunction with your mobile phone and Honda is not liable for any costs you might incur from such use. Honda recommends you consult your mobile phone network provider in advance.
- Downloading applications from the Honda App Center will be subject to Terms and Conditions which can be found at: <https://ivhs.os.ixonos.com/honda/category/carApps.html>, and may also incur charges.

\* Not available on all models

## Smartphone Connection

Some of your smartphone apps can be displayed and operated on the audio/information screen when the phone is connected to the audio system. You can connect your phone using a cable.

📱 **Phone Setup** P. 459

📱 **Connecting Your iPhone** P. 368

📱 **Connecting Your Smartphone** P. 369

### 📱 Smartphone Connection

Park in a safe place before connecting your phone and while operating the displayed apps.

Not all phones are compatible with the system. The system does not display all the available apps on your smartphone, and some apps need to be preinstalled. Ask a dealer for details.

You need to switch the *Bluetooth*® connection to your smartphone if another electronic device is connected.

📱 **To change the currently paired phone**  
P. 460

The following may vary by phone type:

- How to connect a smartphone to the system.
- Apps that can be operated on the screen.
- Display response time/update time

We do not support every app operation on the audio system.

Ask the app provider for any queries on the app's features.

Do not get drawn into the display while operating a vehicle.

To use smartphone connection, you need to first pair your smartphone to the audio system via *Bluetooth*®.

▶ **Phone Setup** P. 459

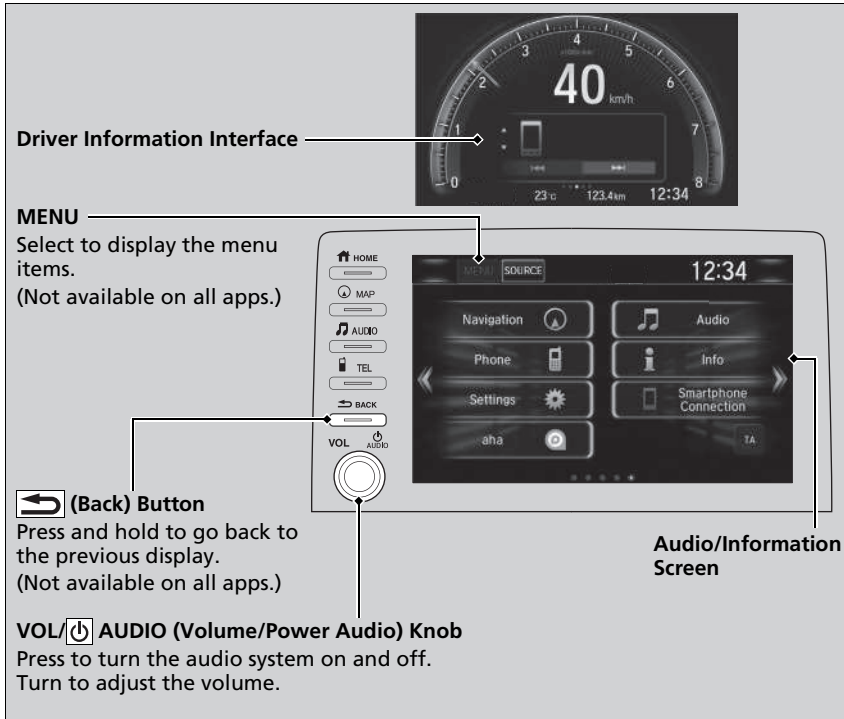

## ■ Connecting Your iPhone

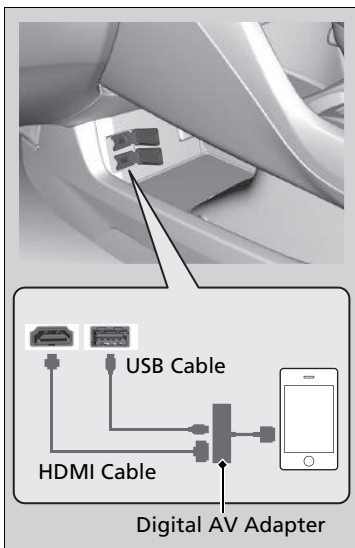

1. Connect your phone to the audio system via *Bluetooth*®.  
▶ **Phone Setup** P. 459
2. Plug in the digital AV adapter to the HDMI™ port.
3. Connect the digital AV adapter to your iPhone.  
▶ Wait until **Smartphone Connection** turns on.
4. Select **Smartphone Connection** to display the available smartphone apps on the audio/information screen.  
▶ You may need to operate from the phone.
5. Select an app you want to operate from the audio/information screen.  
▶ To go back to the previous screen, press the  button.

## ☒ Connecting Your iPhone

Make sure to plug in the digital AV adapter to the HDMI™ port first. If not, smartphone connection may not work properly.

To recharge your phone, connect it to the USB port, too.

Contact a dealer for the digital AV adapter or HDMI™ purchasing information.



## ■ Connecting Your Smartphone

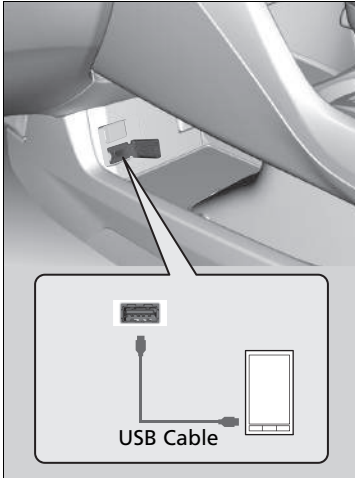

1. Connect your phone to the audio system via *Bluetooth*®.  
 ▶ **Phone Setup** P. 459
2. Plug in your phone to the USB port.
  - ▶ You may need to operate from the phone.
  - ▶ Wait until **Smartphone Connection** turns on.
3. Select **Smartphone Connection** to display the available smartphone apps on the audio/information screen.
4. Select an app you want to operate from the audio/information screen.
  - ▶ To go back to the previous screen, press the  button.

## ▣ Connecting Your Smartphone

The phone is rechargeable while being connected to the USB port. However, if the phone is overloaded with many operational tasks, the battery level may get lowered.

## Wi-Fi Connection

You can connect the Display Audio to the Internet using Wi-Fi and browse websites or use online services on the audio/information screen. If your phone has wireless hotspot capabilities, the system can be tethered to the phone. Use the following steps to setup.

### Wi-Fi mode (setting for the first time)

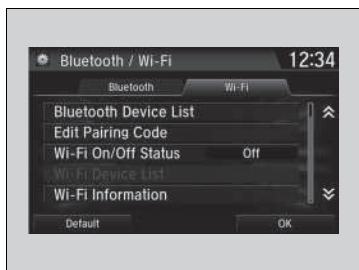

1. Press the button.
2. Select **Settings**.
3. Select **Bluetooth / Wi-Fi**.
4. Select the **Wi-Fi** tab.
5. Select **Wi-Fi On/Off Status**, then **On**.
6. Select **Wi-Fi Device List**.

- ▶ Make sure your phone's Wi-Fi setting is in access point (tethering) mode.
- ▶ Select the phone you want to connect to the system.
- ▶ If you do not find the phone you want to connect in the list, select **Scan**.

7. Select **Add**.

- ▶ If needed, enter a password for your phone and select **OK**.
- ▶ When the connection is successful, the icon is displayed on the top of the screen.

8. Press the button to go back to the home screen.

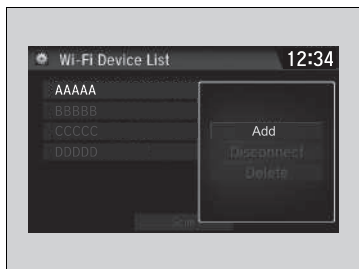

### Wi-Fi mode (setting for the first time)

You cannot go through the setting procedure while a vehicle is moving. Park in a safe place to setup the Wi-Fi connection.

Some mobile phone carriers charge for tethering and smartphone data use. Check your phone's data subscription package.

Check your phone manual to find out if the phone has Wi-Fi connectivity.

You can confirm whether Wi-Fi connection is on or off with the icon on the **Wi-Fi Device List** screen. Network speed will not be displayed on this screen.

### ■ Wi-Fi mode (after the initial setting has been made)

Make sure your phone's Wi-Fi setting is in access point (tethering) mode.

### ▣ Wi-Fi mode (after the initial setting has been made)

#### iPhone users

You may need to go through an initial setup for Wi-Fi connection again after you boot your phone.

## Siri Eyes Free

You can talk to Siri using the  (Talk) button on the steering wheel when your iPhone is paired to the Hands-Free Telephone (HFT) system.

 **Phone Setup** P. 459

### Using Siri Eyes Free

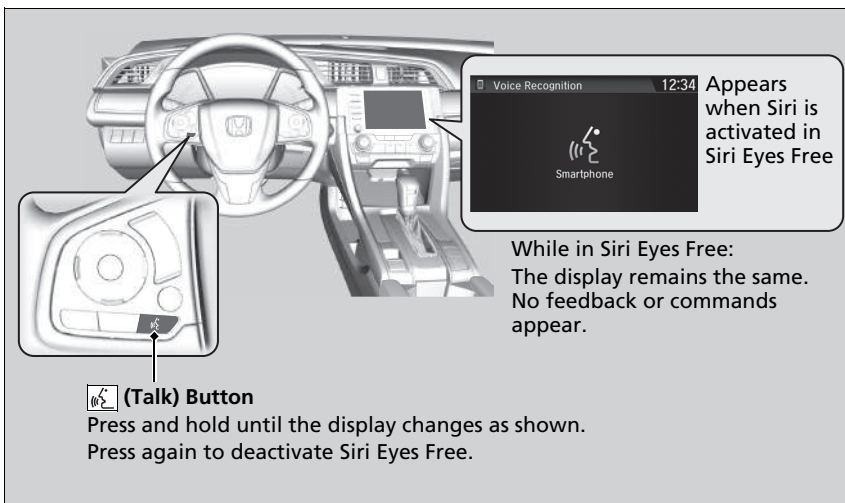

#### ❏ Siri Eyes Free

Siri is a trademark of Apple Inc.

Check Apple Inc. website for features available for Siri.

We recommend against using Siri other than in Siri Eyes Free while operating a vehicle.

#### ❏ Using Siri Eyes Free

Some commands work only on specific phone features or apps.

## Apple CarPlay

If you connect an Apple CarPlay-compatible iPhone to the system via the 1.5A USB port, you can use the audio/information screen, instead of the iPhone display, to make a phone call, listen to music, view maps (navigation), and access messages.

▶ **USB Port(s)** P. 285

### ■ Apple CarPlay Menu

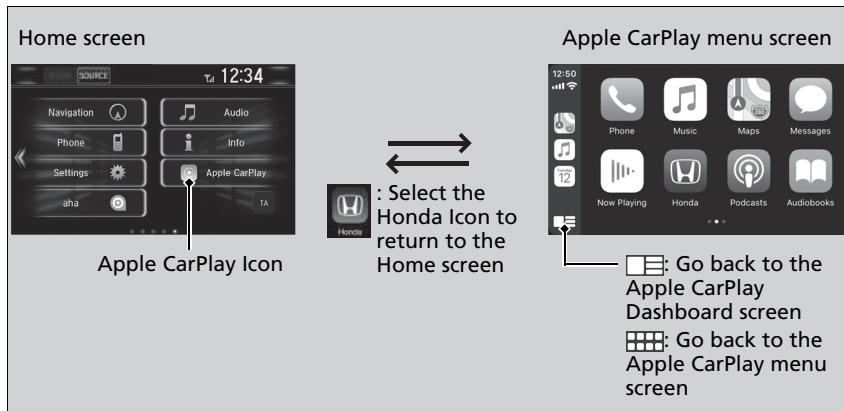

#### ■ Phone

Access the contact list, make phone calls, or listen to voice mail.

#### ■ Messages

Check and reply to text messages, or have messages read to you.

#### ■ Music

Play music stored on your iPhone.

### ▶▶ Apple CarPlay

Only iPhone 5 or newer versions with iOS 8.4 or later are compatible with Apple CarPlay.

Park in a safe place before connecting your iPhone to Apple CarPlay and when launching any compatible apps.

To use Apple CarPlay, connect the USB cable to the 1.5A USB port. The USB port located in the centre console storage will not enable Apple CarPlay operation.

▶ **USB Port(s)** P. 285

To directly access the Apple CarPlay phone function, select **Phone** on the home screen. While connected to Apple CarPlay, calls are only made through Apple CarPlay. If you want to make a call with the Hands-Free Telephone system, turn Apple CarPlay OFF or detach the USB cable from your iPhone.

▶ **Setting Up Apple CarPlay** P. 374

When your iPhone is connected to Apple CarPlay, it is not possible to use the *Bluetooth*® Audio or the Hands-Free Telephone system. However, other previously paired phones can stream audio via *Bluetooth*® while Apple CarPlay is connected.

▶ **Phone Setup** P. 459

For details on countries and regions where Apple CarPlay is available, as well as information pertaining to function, refer to the Apple homepage.

## ■ Maps

Display Apple Maps and use the navigation function just as you would on your iPhone.

### Models with navigation system

Only one navigation system (pre-installed navigation or Apple CarPlay) can give directions at a time. When you are using one system, directions to any prior destination set on the other system will be cancelled, and the system you are currently using will direct you to your destination.

## ■ Setting Up Apple CarPlay

After you have connected your iPhone to the system via the 1.5A USB port, use the following procedure to set up Apple CarPlay. Use of Apple CarPlay will result in the transmission of certain user and vehicle information (such as vehicle location, speed, and status) to your iPhone to enhance the Apple CarPlay experience. You will need to consent to the sharing of this information on the Display Audio Screen.

## ■ Enabling Apple CarPlay

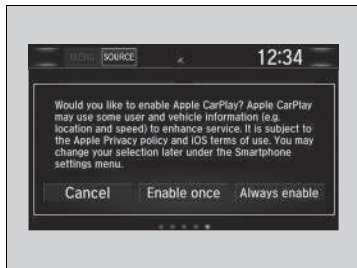

**Enable once:** Allows only once. (Prompt shows again next time.)

**Always enable:** Allows anytime. (Prompt does not show again.)

**Cancel:** Does not allow this consent.

You may change the consent settings under the **Smartphone** settings menu.

## ☒ Apple CarPlay

### Apple CarPlay Operating Requirements & Limitations

Apple CarPlay requires a compatible iPhone with an active mobile connection and data plan. Your carrier's rate plans will apply.

Changes in operating systems, hardware, software, and other technology integral to providing Apple CarPlay functionality, as well as new or revised governmental regulations, may result in a decrease or cessation of Apple CarPlay functionality and services. Honda cannot and does not provide any warranty or guarantee of future Apple CarPlay performance or functionality.

It is possible to use 3rd party apps if they are compatible with Apple CarPlay. Refer to the Apple homepage for information on compatible apps.

## ☒ Setting Up Apple CarPlay

You can also use the method below to set up Apple CarPlay:

Press the  button → Select **Settings** → **Smartphone** → **Apple CarPlay**

### Use of user and vehicle information

The use and handling of user and vehicle information transmitted to/from your iPhone by Apple CarPlay is governed by the Apple iOS terms and conditions and Apple's Privacy Policy.

## ■ Operating Apple CarPlay with Siri

Press and hold the  (talk) button to activate Siri.



## ▣ Operating Apple CarPlay with Siri

Below are examples of questions and commands for Siri.

- What movies are playing today?
- Call dad at work.
- What song is this?
- How's the weather tomorrow?
- Read my latest email.

For more information, please visit [www.apple.com/ios/siri](http://www.apple.com/ios/siri).

## Android Auto

When you connect an Android phone to the Display Audio system via the 1.5A USB port, Android Auto is automatically initiated. When connected via Android Auto, you can use the audio/information screen to access the Phone, Google Maps (Navigation), Google Play Music, and Google Now functions. When you first use Android Auto, a tutorial will appear on the screen.

We recommend that you complete this tutorial while safely parked before using Android Auto.

📄 **USB Port(s)** P. 285

📄 **Auto Pairing Connection** P. 378

### NOTE:

Android Auto may not be available in your country or region. For details about Android Auto, please refer to the Google support site.

### 📄 Android Auto

To use Android Auto, you need to download the Android Auto app from Google Play to your smartphone.

Only Android 5.0 (Lollipop) or later versions are compatible with Android Auto. Bluetooth A2DP cannot be used with Android Auto phone.

Park in a safe place before connecting your Android phone to Android Auto and when launching any compatible apps.

To use Android Auto, connect the USB cable to the 1.5A USB port. The USB port in the centre console storage will not enable Android Auto operation.

📄 **USB Port(s)** P. 285

When your Android phone is connected to Android Auto, it is not possible to use the *Bluetooth*® Audio. However, other previously paired phones can stream audio via *Bluetooth*® while Android Auto is connected.

📄 **Phone Setup** P. 459



## Android Auto Menu

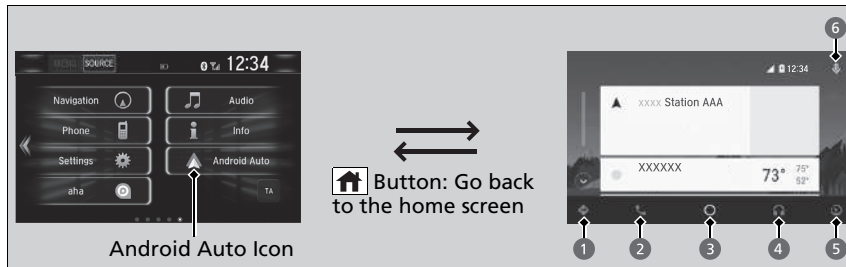

### 1 Maps (Navigation)

Display Google Maps and use the navigation function just as you would with your Android phone. When the vehicle is in motion, it is not possible to make keyboard entries. Stop the vehicle in a safe location to undertake a search or provide other inputs.

#### Models with navigation system

Only one navigation system (pre-installed navigation or Android Auto) can give directions at a time. When you are using one system, directions to any prior destination set on the other system will be cancelled, and the system you are currently using will direct you to your destination.

The audio/information screen shows you turn-by-turn driving directions to your destination.

### 2 Phone (Communication)

Make and receive phone calls as well as listen to voicemail.

### 3 Google Now (Home screen)

Display useful information organized by Android Auto into simple cards that appear just when they're needed.

## Android Auto

For details on countries and regions where Android Auto is available, as well as information pertaining to function, refer to the Android Auto homepage.

Screens may differ depending on the version of the Android Auto app you are using.

### Android Auto Operating Requirements & Limitations

Android Auto requires a compatible Android phone with an active mobile connection and data plan. Your carrier's rate plans will apply.

Changes in operating systems, hardware, software, and other technology integral to providing Android Auto functionality, as well as new or revised governmental regulations, may result in a decrease or cessation of Android Auto functionality and services. Honda cannot and does not provide any warranty or guarantee of future Android Auto performance or functionality.

It is possible to use 3rd party apps if they are compatible with Android Auto. Refer to the Android Auto homepage for information on compatible apps.

#### 4 Music and audio

Play Google Play Music and music apps that are compatible with Android Auto.

To switch between music apps, press this icon.

#### 5 Go back to the Home Screen.

#### 6 Voice

Operate Android Auto with your voice.

### Auto Pairing Connection

When you connect an Android phone to the unit via the 1.5A USB port, Android Auto is automatically initiated.

#### Enabling Android Auto

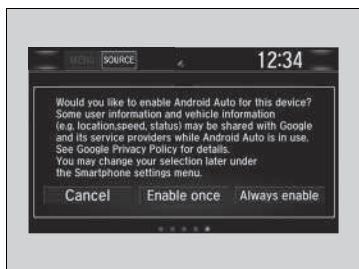

**Enable once:** Allows only once. (Prompt shows again next time.)

**Always enable:** Allows anytime. (Prompt does not show again.)

**Cancel:** Does not allow this consent.

You may change the consent settings under the **Smartphone** settings menu.

#### Enabling Android Auto

Only initialize Android Auto when you safely parked. When Android Auto first detects your phone, you will need to set up your phone so that auto pairing is possible. Refer to the instruction manual that came with your phone.

You can use the method below to change Android Auto settings after you have completed the initial setup:

Press the  button → Select **Settings** → **Smartphone** → **Android Auto**

#### Use of user and vehicle information

The use and handling of user and vehicle information transmitted to/from your phone by Android Auto is governed by the Google's Privacy Policy.

## ■ Operating Android Auto with Voice Recognition

Press and hold the  (talk) button to operate Android Auto with your voice.

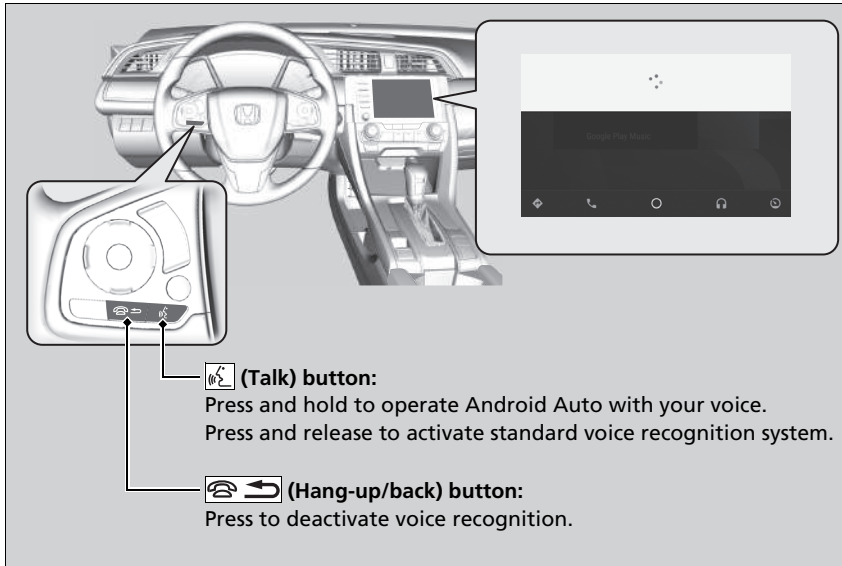

## ▣ Operating Android Auto with Voice Recognition

Below are examples of commands you can give with voice recognition:

- Reply to text.
- Call my wife.
- Navigate to Honda.
- Play my music.
- Send a text message to my wife.
- Call flower shop.

For more information, please refer to the Android Auto homepage.

You can also activate the voice recognition function by pressing the  icon in the upper-right corner of the screen.

# Audio Error Messages

## iPod/USB Flash Drive

If an error occurs while playing an iPod or USB flash drive, you may see the following error messages. If you cannot clear the error message, contact a dealer.

Error Message	Solution
<b>USB error</b> <sup>*1</sup> <b>USB Error</b> <sup>*2</sup>	Appears when there is a problem with the audio system. Check if the device is compatible with the audio system.
<b>Incompatible USB device</b> <b>Please check owners manual.</b> <sup>*1</sup> <b>A charging error has occurred with the connected USB device. When safe please check the compatibility of the device and USB cable and try again.</b> <sup>*2</sup>	Appears when an incompatible device is connected. Disconnect the device. Then turn the audio system off, and turn it on again. Do not reconnect the device that caused the error.
<b>Unsupported ver</b> <sup>*1</sup> <b>Unsupported Version</b> <sup>*2</sup>	Appears when an unsupported iPod is connected. If it appears when a supported iPod is connected, update the iPod software to the newer version.
<b>Retry connection</b> <sup>*1</sup> <b>Connect Retry</b> <sup>*2</sup>	Appears when the system does not acknowledge the iPod. Reconnect the iPod.
<b>Unplayable file</b> <sup>*1</sup> <b>Unplayable File</b> <sup>*2</sup>	Appears when the files in the USB flash drive are copyright protected or an unsupported format. This error message appears for about three seconds, then plays the next song.
<b>No song</b> <sup>*1</sup> <b>No Data</b> <sup>*2</sup>	<p><b>iPod</b> Appears when the iPod is empty.</p> <p><b>USB flash drive</b> Appears when the USB flash drive is empty or there are no MP3, WMA, AAC, or WAV<sup>*2</sup> files in the USB flash drive.</p> <p><b>iPod and USB flash drive</b> Check that compatible files are stored on the device.</p>

\*1: Models with colour audio system

\*2: Models with Display Audio

Error Message	Solution
<b>Unsupported</b> *1, *2	Appears when an unsupported device is connected. If it appears when a supported device is connected, reconnect the device.

\*1: Models with colour audio system

\*2: Models with Display Audio

Models with Display Audio

## Android/Apps

If an error occurs while using the audio system or apps, you may see the following error messages. If you cannot clear the error message, contact a dealer.

Error Message*1	Solution
<b>Unfortunately, **** has stopped.</b>	Error has occurred within app, select <b>OK</b> on the screen to close the app.
<b>**** is not responding. Would you like to close it?</b>	App is not responding. Select <b>Wait</b> if you can wait for a response from app a little longer. If it does not respond even if you keep waiting, select <b>OK</b> to close the app and restart it. If the error message continues, perform <b>Factory Data Reset</b> .  <b>Defaulting All the Settings</b> P. 429

\*1: \*\*\*\*part is variable characters, and will change depending upon where an error occurs.

# General Information on the Audio System

## Compatible iPod, iPhone, and USB Flash Drives

### iPod and iPhone Model Compatibility

Model
iPod (5th generation)
iPod classic 80GB/160GB (launch in 2007)
iPod classic 120GB (launch in 2008)
iPod classic 160GB (launch in 2009)
iPod nano (1st to 7th generation) released between 2005 and 2012
iPod touch (1st to 5th generation) released between 2007 and 2012
iPhone 3G/iPhone 3GS/iPhone 4/iPhone 4s/iPhone 5/iPhone 5c* <sup>1</sup> /iPhone 5s* <sup>1</sup> / iPhone 6* <sup>1</sup> /iPhone 6 Plus* <sup>1</sup>

\* 1: Models with Display Audio

### USB Flash Drives

- A USB flash drive of 256 MB or higher is recommended.
- Some digital audio players may not be compatible.
- Some USB flash drives (e.g., a device with security lockout) may not work.
- Some software files may not allow for audio play or text data display.
- Some versions of MP3, WMA, AAC, or WAV\* formats may be unsupported.

### iPod and iPhone Model Compatibility

This system may not work with all software versions of these devices.

### USB Flash Drives

Files on the USB flash drive are played in their stored order. This order may be different from the order displayed on your PC or device.

Models with Display Audio

■ Recommended Devices

Media	USB Flash Drive	
<b>Profile (MP4 version)</b>	Baseline Level 3 (MPEG4-AVC), Simple Level 5 (MPEG4)	
<b>File extension (MP4 version)</b>	.mp4/.m4v	
<b>Compatible audio codec</b>	AAC	MP3
<b>Compatible video codec</b>	MPEG4-AVC (H.264)	MPEG4 (ISO/IEC 14496 Part.2)
<b>Bit rate</b>	10 Mbps (MPEG4-AVC)	8 Mbps (MPEG4)
<b>Maximum image</b>	720 x 576 pixels	

Models with Display Audio

## Legal Information on Apple CarPlay/Android Auto

---

### OWNER'S MANUAL LICENCE/LIABILITY STATEMENTS

USE OF APPLE CARPLAY IS SUBJECT TO YOUR AGREEMENT TO THE CARPLAY TERMS OF USE, WHICH ARE INCLUDED AS PART OF THE APPLE iOS TERMS OF USE. IN SUMMARY, THE CARPLAY TERMS OF USE DISCLAIM APPLE AND ITS SERVICE PROVIDERS' LIABILITY IF THE SERVICES FAIL TO PERFORM CORRECTLY OR ARE DISCONTINUED, STRICTLY LIMIT APPLE AND ITS SERVICE PROVIDERS' OTHER LIABILITIES, DESCRIBE THE KINDS OF USER INFORMATION (INCLUDING, FOR EXAMPLE, VEHICLE LOCATION, VEHICLE SPEED, AND VEHICLE STATUS) BEING GATHERED AND STORED BY APPLE AND ITS SERVICE PROVIDERS, AND DISCLOSE CERTAIN POSSIBLE RISKS ASSOCIATED WITH THE USE OF CARPLAY, INCLUDING THE POTENTIAL FOR DRIVER DISTRACTION. SEE APPLE'S PRIVACY POLICY FOR DETAILS REGARDING APPLE'S USE AND HANDLING OF DATA UPLOADED BY CARPLAY.

USE OF ANDROID AUTO IS SUBJECT TO YOUR AGREEMENT TO THE ANDROID AUTO TERMS OF USE WHICH MUST BE AGREED TO WHEN THE ANDROID AUTO APPLICATION IS DOWNLOADED TO YOUR ANDROID PHONE. IN SUMMARY, THE ANDROID AUTO TERMS OF USE DISCLAIM GOOGLE AND ITS SERVICE PROVIDERS' LIABILITY IF THE SERVICES FAIL TO PERFORM CORRECTLY OR ARE DISCONTINUED, STRICTLY LIMIT GOOGLE AND ITS SERVICE PROVIDERS' OTHER LIABILITIES, DESCRIBE THE KINDS OF USER INFORMATION (INCLUDING, FOR EXAMPLE, VEHICLE LOCATION, VEHICLE SPEED, AND VEHICLE STATUS) BEING GATHERED AND STORED BY GOOGLE AND ITS SERVICE PROVIDERS, AND DISCLOSE CERTAIN POSSIBLE RISKS ASSOCIATED WITH THE USE OF ANDROID AUTO, INCLUDING THE POTENTIAL FOR DRIVER DISTRACTION. SEE GOOGLE'S PRIVACY POLICY FOR DETAILS REGARDING GOOGLE'S USE AND HANDLING OF DATA UPLOADED BY ANDROID AUTO.



## ■ **DISCLAIMER OF WARRANTIES; LIMITATION ON LIABILITY**





YOU EXPRESSLY ACKNOWLEDGE AND AGREE THAT USE OF APPLE CARPLAY OR ANDROID AUTO (“THE APPLICATIONS”) IS AT YOUR SOLE RISK AND THAT THE ENTIRE RISK AS TO SATISFACTORY QUALITY, PERFORMANCE, ACCURACY AND EFFORT IS WITH YOU TO THE MAXIMUM EXTENT PERMITTED BY APPLICABLE LAW, AND THAT THE APPLICATIONS AND INFORMATION ON THE APPLICATIONS IS PROVIDED “AS IS” AND “AS AVAILABLE,” WITH ALL FAULTS AND WITHOUT WARRANTY OF ANY KIND, AND HONDA HEREBY DISCLAIMS ALL WARRANTIES AND CONDITIONS WITH RESPECT TO THE APPLICATIONS AND INFORMATION ON THE APPLICATIONS, EITHER EXPRESS, IMPLIED OR STATUTORY, INCLUDING, BUT NOT LIMITED TO, THE IMPLIED WARRANTIES AND/OR CONDITIONS OF MERCHANTABILITY, SATISFACTORY QUALITY, FITNESS FOR A PARTICULAR PURPOSE, ACCURACY, QUIET ENJOYMENT, AND NON-INFRINGEMENT OF THIRD PARTY RIGHTS. NO ORAL OR WRITTEN INFORMATION OR ADVICE GIVEN BY HONDA OR AN AUTHORISED REPRESENTATIVE SHALL CREATE A WARRANTY. AS EXAMPLES, AND WITHOUT LIMITATION, HONDA DISCLAIMS ANY WARRANTY REGARDING THE ACCURACY OF DATA PROVIDED BY THE APPLICATIONS, SUCH AS THE ACCURACY OF DIRECTIONS, ESTIMATED TRAVEL TIME, SPEED LIMITS, ROAD CONDITIONS, NEWS, WEATHER, TRAFFIC, OR OTHER CONTENT PROVIDED BY APPLE, GOOGLE, THEIR AFFILIATES, OR THIRD PARTY PROVIDERS; HONDA DOES NOT GUARANTEE AGAINST LOSS OF APPLICATION DATA, WHICH MAY BE LOST AT ANY TIME; HONDA DOES NOT GUARANTEE THAT THE APPLICATIONS OR ANY SERVICES PROVIDED THROUGH THEM WILL BE PROVIDED AT ALL TIMES OR THAT ANY OR ALL SERVICES WILL BE AVAILABLE AT ANY PARTICULAR TIME OR LOCATION. FOR EXAMPLE, SERVICES MAY BE SUSPENDED OR INTERRUPTED WITHOUT NOTICE FOR REPAIR, MAINTENANCE, SECURITY FIXES, UPDATES, ETC., SERVICES MAY BE UNAVAILABLE IN YOUR AREA OR LOCATION, ETC. IN ADDITION, YOU UNDERSTAND THAT CHANGES IN THIRD PARTY TECHNOLOGY OR GOVERNMENT REGULATION MAY RENDER THE SERVICES AND/OR APPLICATIONS OBSOLETE AND/OR UNUSABLE.

TO THE EXTENT NOT PROHIBITED BY LAW, IN NO EVENT SHALL HONDA OR ITS AFFILIATES BE LIABLE FOR PERSONAL INJURY, OR ANY INCIDENTAL, SPECIAL, INDIRECT OR CONSEQUENTIAL DAMAGES WHATSOEVER, INCLUDING, WITHOUT LIMITATION, DAMAGES FOR LOSS OF PROFITS, CORRUPTION OR LOSS OF DATA, FAILURE TO TRANSMIT OR RECEIVE ANY DATA, BUSINESS INTERRUPTION OR ANY OTHER COMMERCIAL DAMAGES OR LOSSES, ARISING OUT OF OR RELATED TO THE APPLICATIONS OR YOUR USE OF OR INABILITY TO USE THE APPLICATIONS OR INFORMATION ON THE APPLICATIONS, HOWEVER CAUSED, REGARDLESS OF THE THEORY OF LIABILITY (CONTRACT, TORT OR OTHERWISE) AND EVEN IF HONDA WERE ADVISED OF THE POSSIBILITY OF SUCH DAMAGES. SOME REGIONS AND JURISDICTIONS MAY DISALLOW THE EXCLUSION OR LIMITATION OF LIABILITY FOR DAMAGES, SO THESE LIMITATIONS AND EXCLUSIONS MAY NOT APPLY TO YOU. THE FOREGOING LIMITATIONS WILL APPLY EVEN IF THE ABOVE STATED REMEDY FAILS OF ITS ESSENTIAL PURPOSE.

## About Open Source Licences

To see the open source licences information, follow these steps.

### Models with colour audio system

1. Press the **MENU/CLOCK** button.
2. Rotate  to select **Settings**, then press .
3. Rotate  to select **OSS Licenses**, then press .

### Models with Display Audio

1. Press the  button.
2. Select **Settings**.
3. Select **System**.
4. Select the **Others** tab.
5. Select **Detailed Information**.
6. Select **About device**.
7. Select **Legal information**.
8. Select **Open-source licences**.

### ►► About Open Source Licences

#### Models with colour audio system

LICENCE: Copyright © 2001 Bob Trower, Trantor Standard Systems Inc.

Permission is hereby granted, free of charge, to any person obtaining a copy of this software and associated documentation files (the "Software"), to deal in the Software without restriction, including without limitation the rights to use, copy, modify, merge, publish, distribute, sublicense, and/or sell copies of the Software, and to permit persons to whom the Software is furnished to do so, subject to the following conditions:

The above copyright notice and this permission notice shall be included in all copies or substantial portions of the Software.

THE SOFTWARE IS PROVIDED "AS IS", WITHOUT WARRANTY OF ANY KIND, EXPRESS OR IMPLIED, INCLUDING BUT NOT LIMITED TO THE WARRANTIES OF MERCHANTABILITY, FITNESS FOR A PARTICULAR PURPOSE AND NONINFRINGEMENT. IN NO EVENT SHALL THE AUTHORS OR COPYRIGHT HOLDERS BE LIABLE FOR ANY CLAIM, DAMAGES OR OTHER LIABILITY, WHETHER IN AN ACTION OF CONTRACT, TORT OR OTHERWISE, ARISING FROM, OUT OF OR IN CONNECTION WITH THE SOFTWARE OR THE USE OR OTHER DEALINGS IN THE SOFTWARE.

## Licence information \*

### ■ DTS

For DTS patents, see <http://patents.dts.com>. Manufactured under licence from DTS Licensing Limited. DTS, the Symbol, & DTS and the Symbol together are registered trademarks, and DTS Digital Surround and Neural Surround are trademarks of DTS, Inc. © DTS, Inc. All Rights Reserved.



\* Not available on all models

# Customized Features

## Models with colour audio system

Use the audio/information screen to customize certain features.

### ■ How to customize

While the vehicle is at a complete stop with the ignition switch in ON **II**, press the **MENU/CLOCK** button, then select **Settings**. To customize the phone settings, press the  button, then select **Phone setup**.

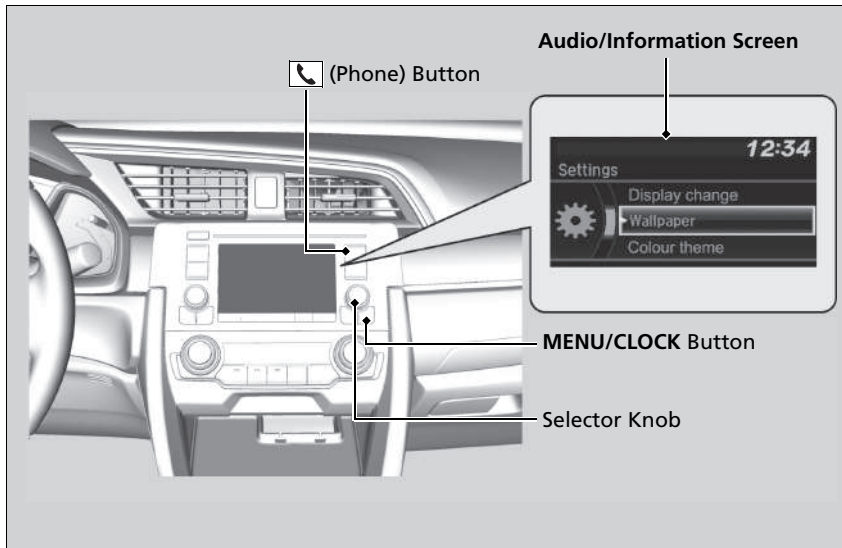

## Customized Features

When you customize settings:

- Make sure that the vehicle is at a complete stop.

### Continuously variable transmission models

- Shift to **P**.

### Manual transmission models

- Set the parking brake.

## How to customize

These indications are used to show how to operate the selector knob.

Rotate  to select.

Press  to enter.

### ■ Customization Flow

Press the **MENU/CLOCK** button.

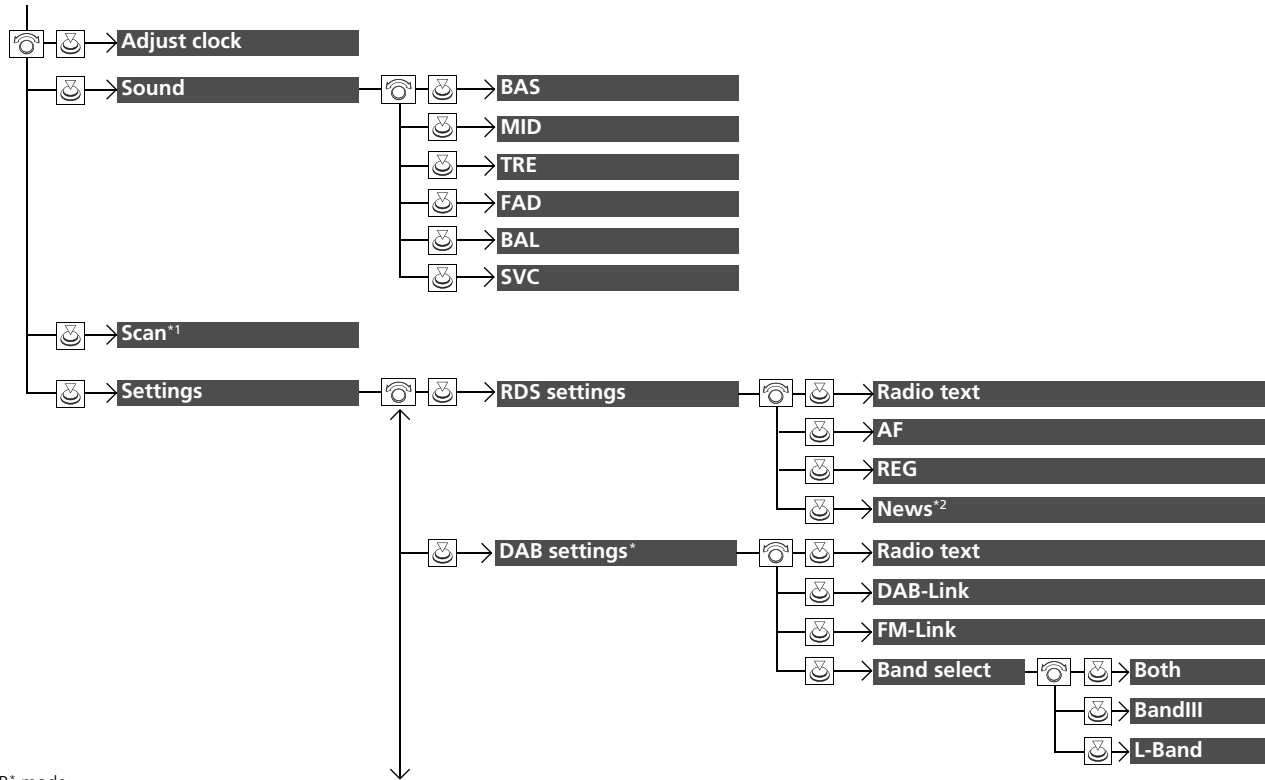

\*1: AM/FM/DAB\* mode  
 \*2: Except AM/FM/DAB\* mode

\* Not available on all models

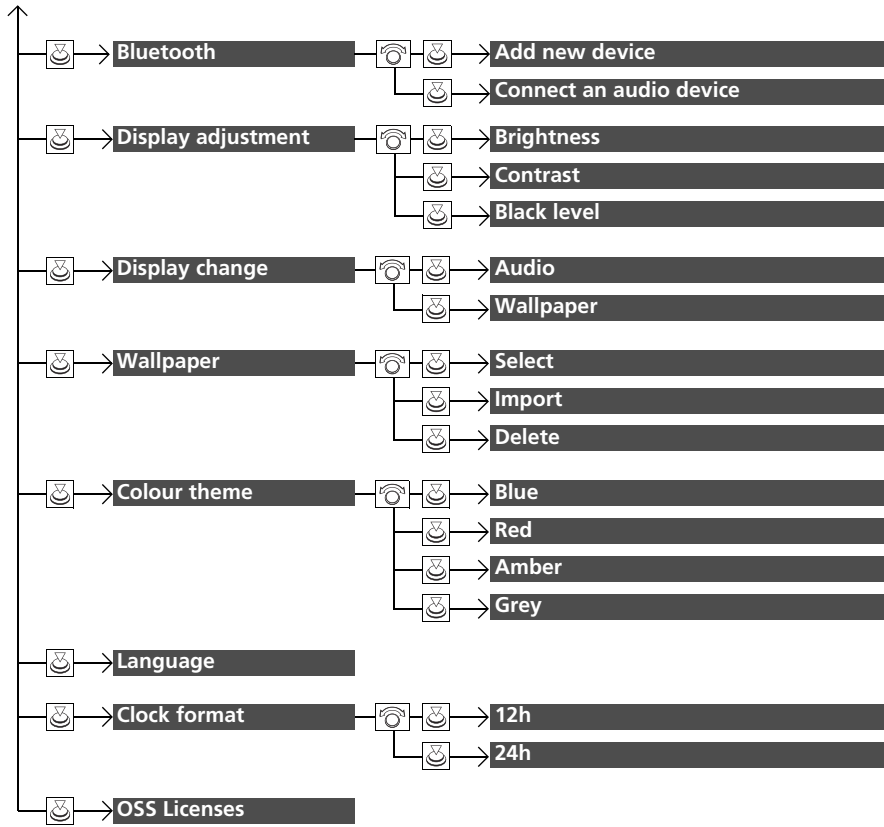

Press the  button and rotate  to select **Phone setup**, then press .

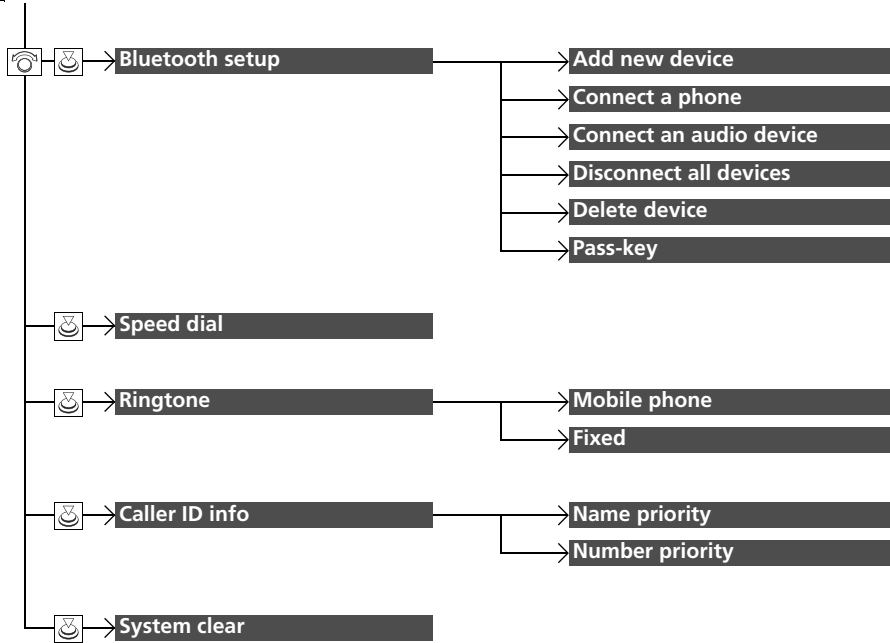

■ List of customizable options

Setup Group	Customizable Features	Description	Selectable Settings	
<b>Settings</b>	<b>Adjust clock</b>	Adjusts clock. ➤ <b>Clock</b> P. 186	—	
	<b>Sound</b>	<b>BAS</b>	Adjusts the settings of the audio speaker's sound. ➤ <b>Adjusting the Sound</b> P. 295	—
		<b>MID</b>		
		<b>TRE</b>		
		<b>FAD</b>		
		<b>BAL</b>		
	<b>SVC</b>			
	<b>Scan</b>	<b>AM/FM/DAB+ mode</b>	Selects the scan mode. ➤ <b>Scan</b> P. 302, 304	—
	<b>RDS settings</b>	<b>Radio text</b>	Displays the radio text information of the selected RDS station.	On/Off*1
		<b>AF</b>	Turns on and off to automatically change the frequency of the same programme as you enter different regions.	On*1/Off
<b>REG</b>		Turns on and off to keep the same stations within that region even if the signal gets weak.	On*1/Off	
<b>News</b>		<b>Except AM/FM/DAB+ mode</b> Turns on and off to automatically to tune to the news programme.	On/Off*1	

\*1:Default Setting



Setup Group	Customizable Features	Description	Selectable Settings
Settings	DAB settings*	<b>Radio text</b>	Displays the radio text information of the selected DAB station. On/Off*1
		<b>DAB-Link</b>	Selects whether the system automatically searches for the same station from Ensembles, and switches to it. On*/Off
		<b>FM-Link</b>	Selects whether the system finds the same station from an FM band, and automatically switches the band. On*/Off
		<b>Band select</b>	Selects specific bands to reduce the time to update the lists, and search for a station. <b>Both*1/BandIII/L-Band</b>
	Bluetooth	<b>Add new device</b>	Pairs a new phone to HFT, edits and deletes a paired phone, and create a code for a paired phone. ☒ <b>Phone Setup</b> P. 436 —
		<b>Connect an audio device</b>	Connects, disconnects or pairs a <i>Bluetooth</i> ® Audio device to HFT. —
	Display adjustment	<b>Brightness</b>	Changes the brightness of the audio/information screen. —
		<b>Contrast</b>	Changes the contrast of the audio/information screen. —
		<b>Black level</b>	Changes the black level of the audio/information screen. —

\*1: Default Setting

\* Not available on all models

Setup Group	Customizable Features	Description	Selectable Settings
Settings	<b>Display change</b>	Changes the display type.	<b>Audio<sup>*1</sup>/Wallpaper</b>
	<b>Select</b>	Changes the wallpaper type.	<b>Clock<sup>*1</sup>/Image 1/ Image 2/Image 3</b>
	<b>Wallpaper</b>	Imports an image file for a new wallpaper. <b>Wallpaper Setup</b> P. 293	—
	<b>Import</b>		
	<b>Delete</b>	Deletes an image file for a wallpaper.	<b>Image 1<sup>*1</sup>/Image 2/ Image 3</b>
	<b>Colour theme</b>	Changes the background colour of the audio/ information screen.	<b>Blue<sup>*1</sup>/Red/Amber/ Grey</b>
	<b>Language</b>	Changes the display language.	<b>English<sup>*1</sup> or Türkçe<sup>*1</sup>;</b> See other selectable languages on the screen.
<b>Clock format</b>	Selects the digital clock display from 12H to 24H.	<b>12h<sup>*1</sup>/24h</b>	
<b>OSS Licenses</b>	Shows the legal information.	—	

\*1:Default Setting

Setup Group	Customizable Features	Description	Selectable Settings
Phone setup	<b>Add new device</b>	Pairs a new phone to HFT. ➤ <b>Phone Setup</b> P. 436	—
	<b>Bluetooth setup</b> <b>Connect a phone</b>	Pairs a new phone or connects a paired phone to HFT. ➤ <b>Phone Setup</b> P. 436	—
	<b>Connect an audio device</b>	Connects a <i>Bluetooth</i> ® Audio device to HFT.	—
	<b>Disconnect all devices</b>	Disconnects a paired phone from HFT.	—
	<b>Delete device</b>	Deletes a paired phone.	—
	<b>Pass-key</b>	Inputs and changes a code for a paired phone.	—
	<b>Speed dial</b>	Edits, adds or deletes a speed dial entry. ➤ <b>Speed Dial</b> P. 445	—
	<b>Ringtone</b>	Selects a fixed ring tone or the one from the connected mobile phone.	<b>Mobile phone</b> <sup>*1</sup> / <b>Fixed</b>
	<b>Caller ID info</b>	Prioritizes the caller's name or phone number as the caller ID.	<b>Name priority</b> <sup>*1</sup> / <b>Number priority</b>
	<b>System clear</b>	Cancels/Resets all customized items in the <b>Phone setup</b> group as default.	—



\*1:Default Setting

# Customized Features

## Models with Display Audio

Use the audio/information screen to customize certain features.

### ■ How to customize

While the vehicle is at a complete stop with the ignition switch in ON <sup>\*1</sup>, press the  button, and select **Settings**, then select a setting item.



## ➤ Customized Features

When you customize settings:

- Make sure that the vehicle is at a complete stop.

### ➤ Continuously variable transmission models

- Shift to .

### ➤ Manual transmission models

- Set the parking brake.

To customize features detail, refer to the following.

➤ **Customization flow** P. 397

➤ **List of customizable options** P. 405

\* 1: Models with the keyless access system have an **ENGINE START/STOP** button instead of an ignition switch.

■ Customization flow

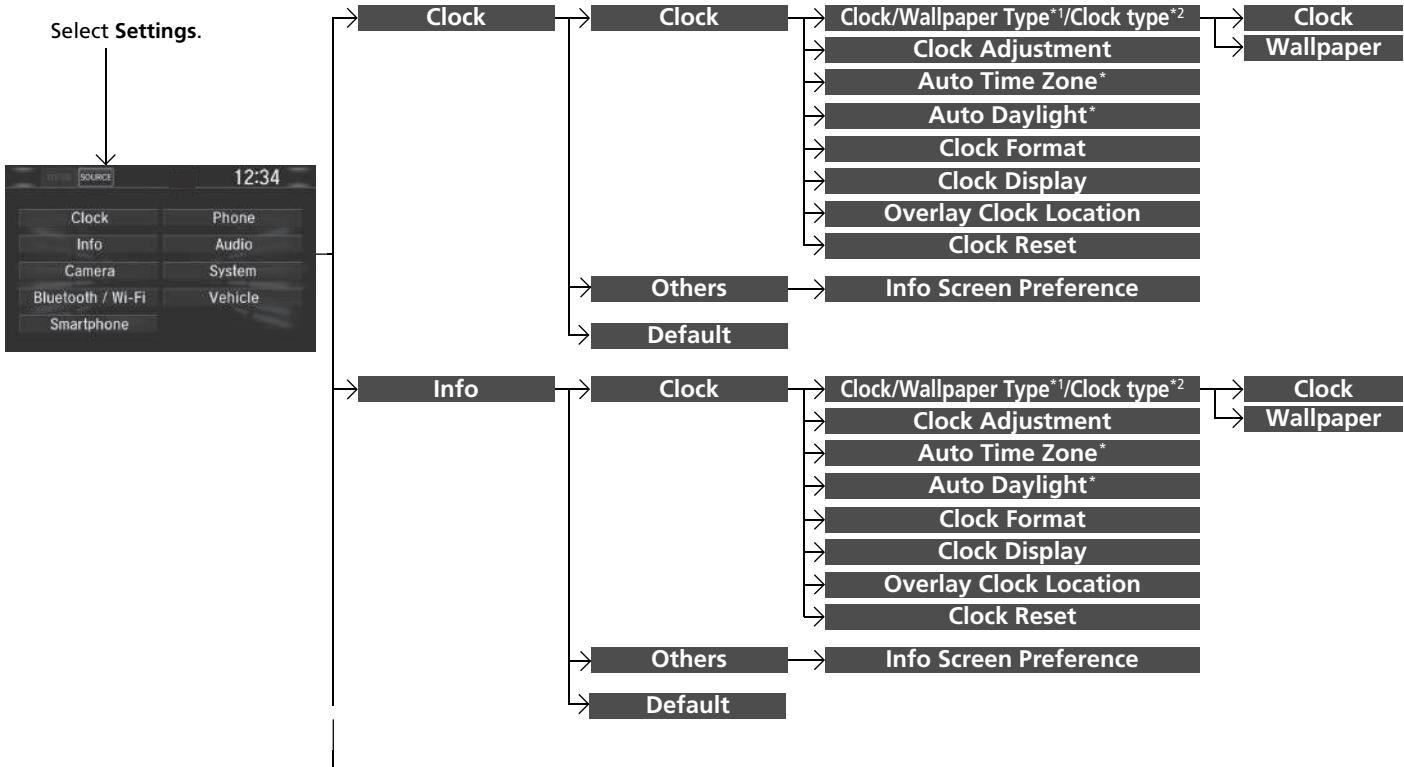

\*1: Does not appear when you change the screen interface design.

\*2: Appears only when you change the screen interface design.

\* Not available on all models

Features

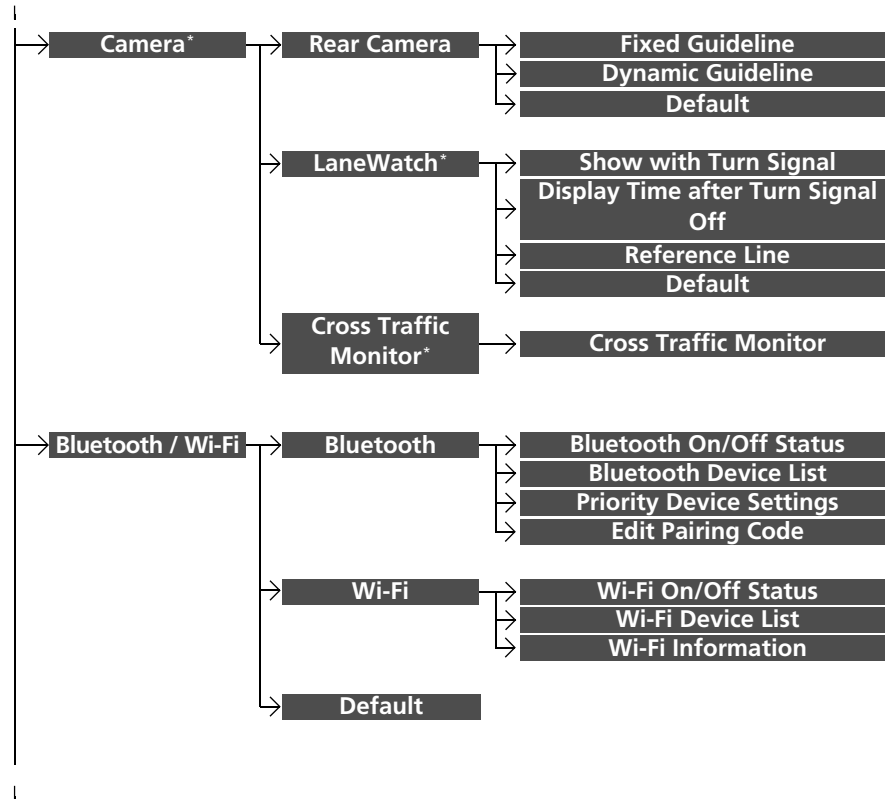

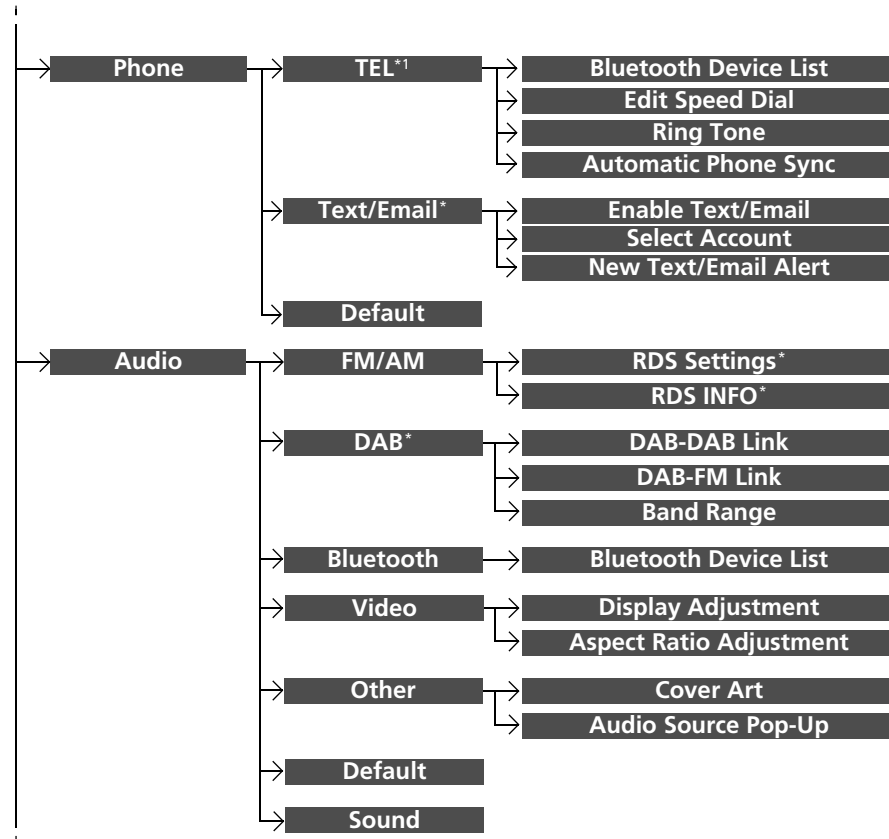

Features

\*1: TEL tab is displayed depending on models.

\* Not available on all models

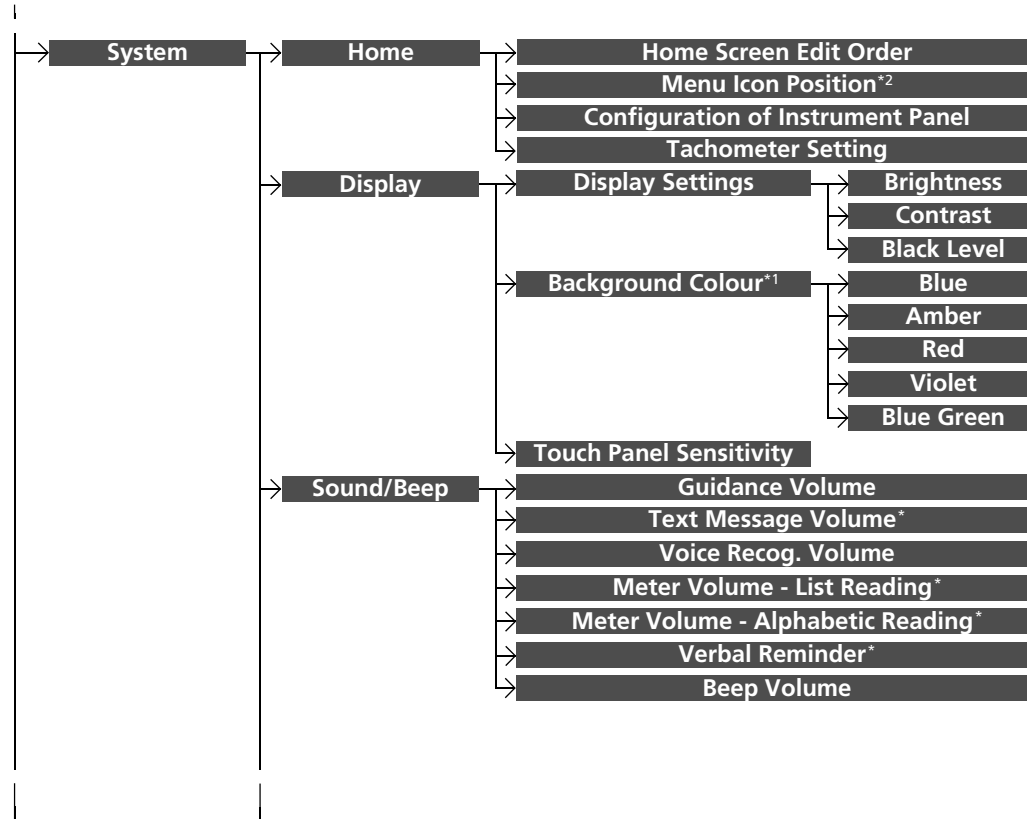

\*1: Does not appear when you change the screen interface design.

\*2: Appears only when you change the screen interface design.



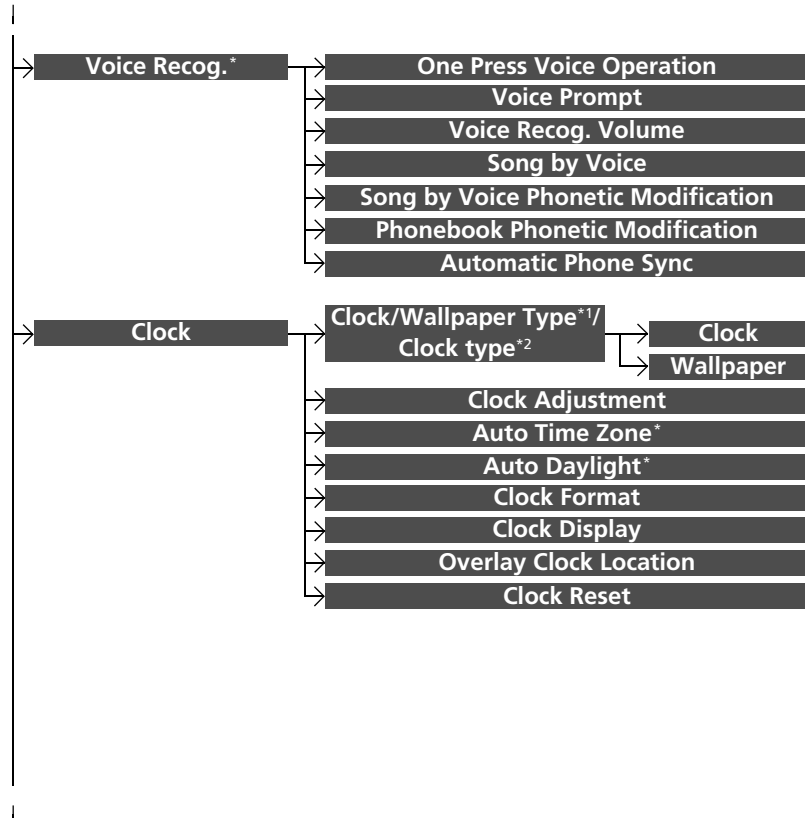

Features

\*1: Does not appear when you change the screen interface design.

\*2: Appears only when you change the screen interface design.

\* Not available on all models

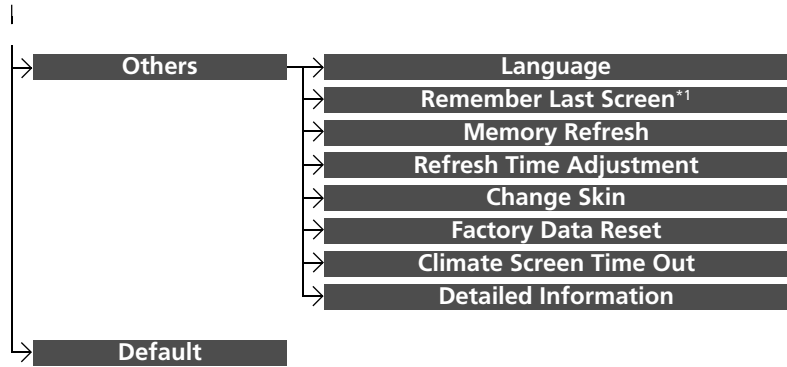

\*1: Does not appear when you change the screen interface design.

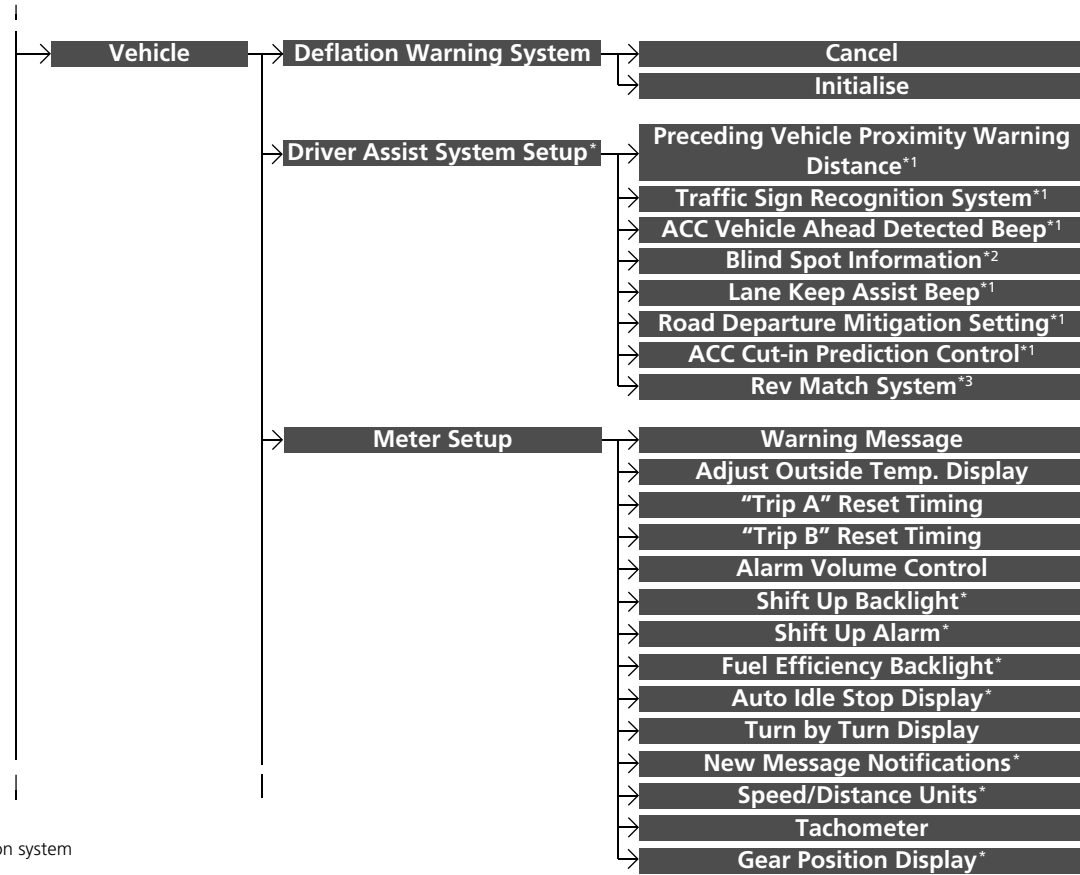

Features

\*1: Models with CMBS

\*2: Models with blind spot information system

\*3: 2.0 L engine models

\* Not available on all models

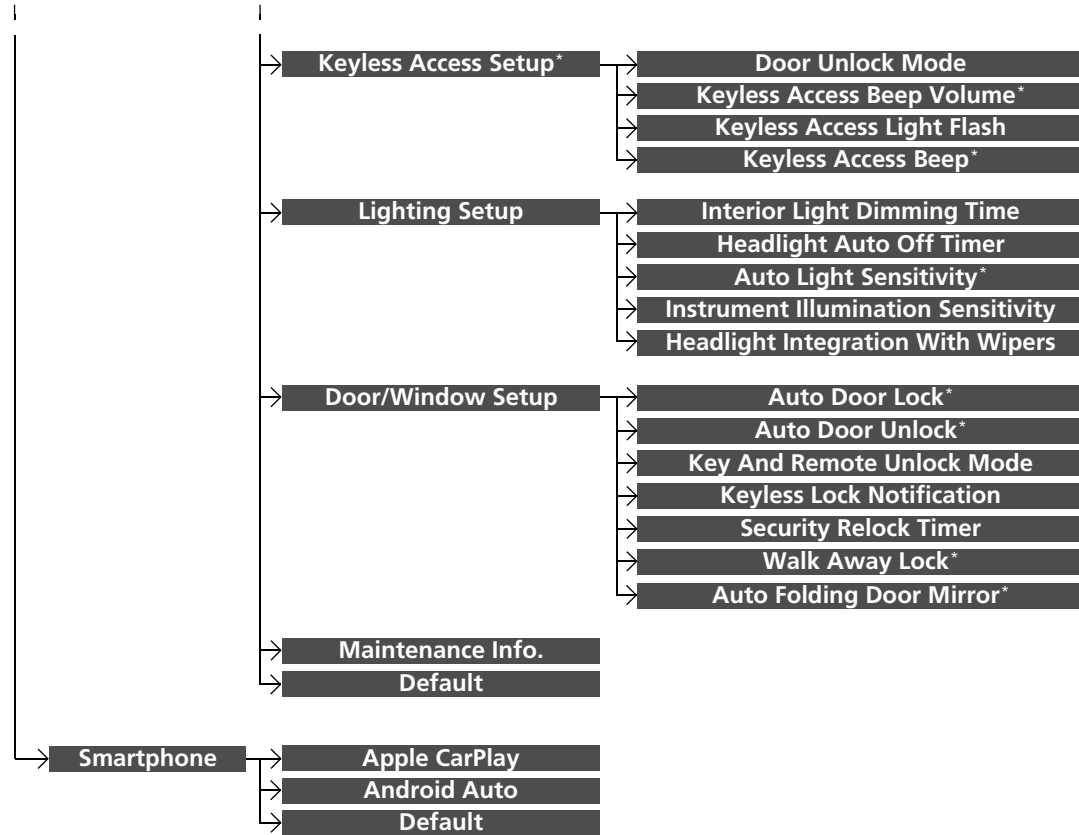

■ List of customizable options

Setup Group	Customizable Features	Description	Selectable Settings	
Clock	Clock/ Wallpaper Type <sup>*1</sup> / Clock type <sup>*2</sup>	Clock Wallpaper		
	Clock Adjustment			
	Auto Time Zone*			
	Auto Daylight*	See <b>Info</b> on P. 406		
	Clock Format			
	Clock Display			
	Overlay Clock Location			
	Clock Reset			
	Others	Info Screen Preference		
	Default	Cancels/Resets all customized items in the <b>Clock</b> settings group as default.		Yes/No

\*1: Does not appear when you change the screen interface design.

\*2: Appears only when you change the screen interface design.

\* Not available on all models

Setup Group	Customizable Features	Description	Selectable Settings	
<b>Info</b>	<b>Clock/ Wallpaper Type<sup>*2/</sup> Clock type<sup>*3</sup></b>	<b>Clock</b>	Changes the clock display type.	<b>Analog/Digital<sup>*1/</sup> Small Digital/Off</b>
		<b>Wallpaper</b>	<ul style="list-style-type: none"> <li>• Changes the wallpaper type.</li> <li>• Imports an image file for a new wallpaper.</li> <li>• Deletes an image file for a wallpaper.</li> </ul>	<b>Blank/Galaxy<sup>*1/</sup> Metallic</b>
	<b>Clock Adjustment</b>		Adjusts Clock.	—
	<b>Auto Time Zone<sup>*</sup></b>		Automatically adjusts the clock when driving through different time zones.	<b>On<sup>*1/</sup>Off</b>
	<b>Auto Daylight<sup>*</sup></b>		Select <b>On</b> to have the GPS automatically adjust the clock to daylight savings time. Select <b>Off</b> to cancel this function.	<b>On<sup>*1/</sup>Off</b>
	<b>Clock Format</b>		Selects the digital clock display from 12H to 24H.	<b>12H<sup>*1/</sup>24H</b>
	<b>Clock Display</b>		Selects whether the clock display comes on.	<b>On<sup>*1/</sup>Off</b>
	<b>Overlay Clock Location</b>		Changes the clock display layout.	<b>Right Upper<sup>*1/</sup>Left Upper/Right Lower/ Left Lower/Off</b>
	<b>Clock Reset</b>		Resets the clock settings to the factory default.	<b>Yes/No</b>

\*1:Default Setting

\*2:Does not appear when you change the screen interface design.

\*3:Appears only when you change the screen interface design.

Setup Group	Customizable Features	Description	Selectable Settings
Info	Others Info Screen Preference	Selects the top menu when the <b>Info</b> is selected. • <b>Info Top</b> - A brief menu pops up. • <b>Info Menu</b> - A full menu pops up. • <b>Off</b> - A menu does not pop up.	<b>Info Top/Info Menu<sup>*1</sup>/Off</b>
	Default	Cancels/Resets all customized items in the <b>Info</b> settings group as default.	<b>Yes/No</b>

\*1:Default Setting

Setup Group	Customizable Features	Description	Selectable Settings
Camera*	Rear Camera	<b>Fixed Guideline</b> Selects whether the fixed guidelines come on the rear camera monitor. ➤ <b>Multi-View Rear Camera*</b> P. 653	<b>On*<sup>1</sup>/Off</b>
		<b>Dynamic Guideline</b> Selects whether the guidelines adjust to the movement of the steering wheel. ➤ <b>Multi-View Rear Camera*</b> P. 653	<b>On*<sup>1</sup>/Off</b>
		<b>Default</b> Cancels/Resets all customized items in the <b>Rear Camera</b> setting group as default.	<b>Yes/No</b>
	LaneWatch*	<b>Show with Turn Signal</b> Selects whether the LaneWatch display comes on when you move the turn signal lever to indicate a left turn.	<b>On*<sup>1</sup>/Off</b>
		<b>Display Time after Turn Signal Off</b> Changes the length of time the LaneWatch display stays on after the turn signal lever returns to the centre.	<b>0 seconds*<sup>1</sup>/ 2 seconds</b>
		<b>Reference Line</b> Selects whether the reference lines come on the LaneWatch monitor.	<b>On*<sup>1</sup>/Off</b>
		<b>Default</b> Cancels/Resets all customized items in the <b>LaneWatch</b> group as default.	<b>Yes/No</b>
	<b>Cross Traffic Monitor*</b>	<b>Cross Traffic Monitor</b> Turns the cross traffic monitor feature on and off.	<b>On*<sup>1</sup>/Off</b>

\*1:Default Setting

\* Not available on all models



Setup Group	Customizable Features	Description	Selectable Settings	
Bluetooth / Wi-Fi	Bluetooth	<b>Bluetooth On/Off Status</b>	Changes the <i>Bluetooth</i> ® status. <b>On*<sup>1</sup>/Off</b>	
		<b>Bluetooth Device List</b>	Pairs a new phone to HFT, edits or deletes a paired phone. ☒ <b>Phone Setup</b> P. 459 —	
		<b>Priority Device Settings</b>	<b>Priority On/Off Status</b>	Enables the system to or disables it from automatically establishing a connection with a <i>Bluetooth</i> ® device which has been assigned priority. <b>On/Off*<sup>1</sup></b>
			<b>Audio</b>	Selects the priority device over another paired audio device(s). —
			<b>Phone</b>	Selects the priority device over another paired phone(s). —
		<b>Edit Pairing Code</b>	Edits a pairing code. ☒ <b>To change the pairing code setting</b> P. 460 <b>Random/Fixed*<sup>1</sup></b>	

\*1:Default Setting

▶▶ Customized Features ▶

Setup Group	Customizable Features	Description	Selectable Settings
<b>Bluetooth / Wi-Fi</b>	<b>Wi-Fi</b>	<b>Wi-Fi On/Off Status</b>	Changes the Wi-Fi mode. <b>On/Off</b> <sup>*1</sup>
		<b>Wi-Fi Device List</b>	Connects, disconnects, or deletes the Wi-Fi device. —
		<b>Wi-Fi Information</b>	Shows the Wi-Fi information of the head unit. —
	<b>Default</b>		Cancels/Resets all customized items in the <b>Bluetooth / Wi-Fi</b> group as default. <b>Yes/No</b>

\*1:Default Setting

Setup Group	Customizable Features	Description	Selectable Settings
Phone	<b>Bluetooth Device List</b>	Pairs a new phone to HFT, connects or disconnects a paired phone. ➤ <b>Phone Setup</b> P. 459	—
	<b>Edit Speed Dial</b>	Edits, adds or deletes a speed dial entry. ➤ <b>Speed Dial</b> P. 465	—
	<b>Ring Tone</b>	Selects a fixed ring tone or the one from the connected mobile phone.	<b>Fixed/Mobile Phone</b> * <sup>1</sup>
	<b>Automatic Phone Sync</b>	Sets a phonebook and call history data to be automatically imported when a phone is paired to HFT.	<b>On</b> * <sup>1</sup> / <b>Off</b>
	<b>Enable Text/Email</b>	Turns the text/e-mail message function on and off.	<b>On</b> * <sup>1</sup> / <b>Off</b>
	<b>Select Account</b>	Selects a text or e-mail message account.	—
	<b>New Text/Email Alert</b>	Selects whether a pop-up alert comes on the screen when HFT receives a new text/e-mail message.	<b>On/Off</b>
<b>Default</b>	Cancels/Resets all customized items in the <b>Phone</b> settings group as default.	<b>Yes/No</b>	

\*1: Default Setting

\*2: **TEL** tab is displayed depending on models.

\* Not available on all models

Setup Group	Customizable Features	Description	Selectable Settings		
Audio	FM/AM mode <b>FM/AM</b>	<b>TA Information</b>	Turns on and off the traffic information.	<b>On/Off</b> <sup>*1</sup>	
		<b>RDS Settings</b> *	<b>AF</b>	Turns on and off to automatically change the frequency of the same programme as you enter different regions.	<b>On</b> <sup>*1</sup> / <b>Off</b>
			<b>REG</b>	Turns on and off to keep the same stations within that region even if the signal gets weak.	<b>On</b> <sup>*1</sup> / <b>Off</b>
			<b>News</b>	Turns on and off to automatically to tune to the news programme.	<b>On/Off</b> <sup>*1</sup>
		<b>RDS INFO</b> *	Turns on and off the RDS information.	<b>On/Off</b> <sup>*1</sup>	
		<b>DAB-DAB Link</b>	Selects whether the system automatically searches for the same station from Ensembles, and switches to it.	<b>On</b> <sup>*1</sup> / <b>Off</b>	
	<b>DAB mode</b> <b>DAB</b> *	<b>DAB-FM Link</b>	Selects whether the system finds the same station from an FM band, and automatically switches the band.	<b>On</b> <sup>*1</sup> / <b>Off</b>	
		<b>Band Range</b>	Selects specific bands to reduce the time to update the lists, and search for a station.	<b>BOTH</b> <sup>*1</sup> / <b>BAND III/L-BAND</b>	

\*1:Default Setting

Setup Group	Customizable Features	Description	Selectable Settings	
Audio	<b>Bluetooth</b> <i>Bluetooth® mode</i> <b>Bluetooth Device List</b>	Pairs a new phone to HFT, edits or deletes a paired phone. 📱 <b>Phone Setup</b> P. 459	—	
	<b>Video</b> <i>USB, HDMI™, Apple CarPlay or Android Auto mode</i> <b>Display Adjustment</b>	<b>Display</b> <b>Brightness</b>	See <b>System</b> on P. 414	—
		<b>Contrast</b>		
		<b>Black Level</b>	Changes the colour of the audio/information screen.	—
		<b>Colour</b>		
	<b>Tint</b>	Changes the tint of the audio/information screen.	—	
<b>Aspect Ratio Adjustment</b> <i>USB, HDMI™ mode</i>	Selects a display mode with a different aspect ratio: <b>Original</b> (only USB), <b>Normal</b> , <b>Full</b> or <b>Zoom</b> .	<b>Original</b> *1 (only USB)/ <b>Normal</b> / <b>Full</b> *1/ <b>Zoom</b>		

\*1:Default Setting

Setup Group	Customizable Features	Description	Selectable Settings
<b>Audio</b>	<b>Other</b>	iPod or USB mode [Your selected media] <b>Cover Art</b>	Turns the cover art display on and off. <b>On*1/Off</b>
		<b>Audio Source Pop-Up</b>	Selects whether the list of selectable audio source comes on when <b>Audio</b> is selected on the home screen. <b>On/Off*1</b>
	<b>Default</b>		Cancels/Resets all customized items in the <b>Audio</b> settings group as default. <b>Yes/No</b>
	<b>Sound</b>		Adjusts the settings of the audio speaker's sound. ➤ <b>Adjusting the Sound</b> P. 337 —
<b>System</b>	<b>Home</b>	<b>Home Screen Edit Order</b>	Changes the home screen icon layout. —
		<b>Menu Icon Position</b> *2	Changes the position of the menu icons on the <b>Audio</b> , <b>Phone</b> , and <b>Info</b> screen. —
		<b>Configuration of Instrument Panel</b>	Changes the <b>Instrument Panel</b> screen icon layout. —
		<b>Tachometer Setting</b>	Turns on and off the tachometer display. <b>On*1/Off</b>

\*1:Default Setting

\*2:Appears only when you change the screen interface design.

Setup Group	Customizable Features	Description	Selectable Settings	
<b>System</b>	<b>Display</b>	<b>Brightness</b>	Changes the brightness of the audio/information screen.	—
		<b>Contrast</b>	Changes the contrast of the audio/information screen.	—
		<b>Black Level</b>	Changes the black level of the audio/information screen.	—
		<b>Background Colour</b> <sup>*2</sup>	Changes the background colour of the audio/information screen.	<b>Blue/Amber/Red</b> <sup>*3</sup> / <b>Violet/Blue Green</b> <sup>*3</sup>
		<b>Touch Panel Sensitivity</b>	Sets the sensitivity of the touch panel screen.	<b>High/Low</b> <sup>*1</sup>

\*1: Default Setting



\*2: Does not appear when you change the screen interface design.

\*3: The default setting varies depending on the model.

Setup Group	Customizable Features	Description	Selectable Settings	
<b>System</b>	<b>Sound/ Beep</b>	<b>Guidance Volume</b>	Changes the sound volume. Adjusts the guidance volume of the navigation system.	<b>00~06*1~11</b>
		<b>Text Message Volume*</b>	Changes the text/e-mail message reading volume.	<b>01~06*1~11</b>
		<b>Voice Recog. Volume</b>	Changes the volume of the voice prompt	<b>01~06*1~11</b>
		<b>Meter Volume - List Reading*</b>	Changes the list reading volume.	<b>00~06*1~11</b>
		<b>Meter Volume - Alphabetic Reading*</b>	Changes the alphabetic reading volume.	<b>00~06*1~11</b>
		<b>Verbal Reminder*</b>	Turns the verbal reminders on and off.	<b>On*1/Off</b>
		<b>Beep Volume</b>	Changes the beep volume.	<b>Off/1/2*1/3</b>

\*1:Default Setting



Setup Group	Customizable Features	Description	Selectable Settings	
System	Voice Recog.*	<b>One Press Voice Operation</b>	Changes the setting of the  (Talk) button operation when using the voice operation.	On <sup>*1</sup> /Off
		<b>Voice Prompt</b>	Turns the voice prompt on and off.	On <sup>*1</sup> /Off
		<b>Voice Recog. Volume</b>	Changes the volume of the voice prompt.	01~06 <sup>*1</sup> ~11
		<b>Song by Voice</b>	Turns the Song By Voice™ on and off.	On <sup>*1</sup> /Off
		<b>Song by Voice Phonetic Modification</b>	Modifies a voice command for music stored in the system or an iPod/iPhone.  <b>Phonetic Modification</b> P. 355	—
		<b>Phonebook Phonetic Modification</b>	Modifies a voice command for the phonebook.  <b>Phonebook Phonetic Modification</b> * P. 468	—
		<b>Automatic Phone Sync</b>	Sets phonebook and call history data to be automatically imported when a phone is paired to HFT.	On/Off

\*1:Default Setting

\* Not available on all models

►► Customized Features ►

Setup Group	Customizable Features	Description	Selectable Settings
System	Clock/ Wallpaper Type <sup>*1</sup> / Clock type <sup>*2</sup>	Clock <hr/> Wallpaper	
	Clock Adjustment		
	Auto Time Zone*		See <b>Info</b> on P. 406
	Auto Daylight*		
	Clock Format		
	Clock Display		
	Overlay Clock Location		
	Clock Reset		

\*1: Does not appear when you change the screen interface design.

\*2: Appears only when you change the screen interface design.

Setup Group	Customizable Features	Description	Selectable Settings
	<b>Language</b>	Change the display language.	<b>English (United Kingdom)*<sup>1</sup></b> or <b>Türkçe*<sup>1</sup></b> : See other selectable languages on the screen.
<b>System</b>	<b>Others</b>	<b>Remember Last Screen*<sup>3</sup></b>	Selects whether the device remembers the last screen. <b>On/Off*<sup>1</sup></b>
		<b>Memory Refresh</b>	Turns on the audio system automatically and restores the fragmentation of a memory when the ignition switch is LOCK <input type="checkbox"/> * <sup>2</sup> . <b>On*<sup>1</sup>/Off</b>
		<b>Refresh Time Adjustment</b>	Sets the time for <b>Memory Refresh</b> . —

\*1:Default Setting

\*2:Models with the keyless access system have an **ENGINE START/STOP** button instead of an ignition switch.

\*3:Does not appear when you change the screen interface design.

►► Customized Features ►

Setup Group	Customizable Features	Description	Selectable Settings
<b>System</b>	<b>Change Skin</b>	Changes the screen interface design.	<b>Yes/No</b>
	<b>Factory Data Reset</b>	Resets all the settings to their factory default. <input checked="" type="checkbox"/> <b>Defaulting All the Settings</b> P. 429	<b>Yes/No</b>
	<b>Others</b> <b>Climate Screen Time Out</b>	Changes the length of time the climate control display stays on when you press the <b>CLIMATE</b> button.	<b>Never/5 seconds/10 seconds*<sup>1</sup>/20 seconds</b>
	<b>Detailed Information</b>	Displays the details of the head unit and operating system information.	—
	<b>Default</b>	Cancels/Resets all customized items in the <b>System</b> group as default.	<b>Yes/No</b>

\*1:Default Setting

Setup Group	Customizable Features	Description	Selectable Settings	
Vehicle	<b>Deflation Warning System</b>	Initialises the deflation warning system.	<b>Cancel/Initialise</b>	
	<b>Driver Assist System Setup*</b>	<b>Preceding Vehicle Proximity Warning Distance<sup>*2</sup></b>	Changes Collision Mitigation Braking System (CMBS) alert distance.	<b>Far/Normal<sup>*1</sup>/Near</b>
		<b>Traffic Sign Recognition System<sup>*2</sup></b>	Selects whether the traffic sign small icons come on.	<b>Small Icons ON<sup>*1</sup>/ Small Icons OFF</b>
		<b>ACC Vehicle Ahead Detected Beep<sup>*2</sup></b>	Causes the system to beep when the system detects a vehicle, or when the vehicle goes out of the ACC range*/ACC with Low Speed Follow range*.	<b>On/Off<sup>*1</sup></b>
		<b>Blind Spot Information<sup>*3</sup></b>	Changes the setting for the blind spot information.	<b>Audible And Visual Alert<sup>*1</sup>/Visual Alert Only/Off</b>

\*1:Default Setting

\*2:Models with CMBS

\*3:Models with blind spot information system

\* Not available on all models

Setup Group	Customizable Features	Description	Selectable Settings	
<b>Vehicle</b>	<b>Driver Assist System Setup*</b>	<b>Lane Keep Assist Beep</b> <sup>*2</sup>	Causes the system to beep when Lane Keeping Assist System (LKAS) is suspended.	<b>On/Off</b> <sup>*1</sup>
		<b>Road Departure Mitigation Setting</b> <sup>*2</sup>	Changes the setting for the road departure mitigation system.	<b>Normal/Delayed</b> <sup>*1</sup> / <b>Warning Only/Early</b>
		<b>ACC Cut-in Prediction Control</b> <sup>*2</sup>	Turns the ACC cut-in prediction control feature on and off.	<b>On</b> <sup>*1</sup> / <b>Off</b>
		<b>Rev Match System</b> <sup>*3</sup>	Turns the Rev Match System feature on and off.	<b>On</b> <sup>*1</sup> / <b>Off</b>

\*1: Default Setting

\*2: Models with CMBS

\*3: 2.0 L engine models

Setup Group	Customizable Features	Description	Selectable Settings	
Vehicle	Meter Setup	<b>Warning Message</b>	Switches warning message to be displayed or not.	On/Off* <sup>1</sup>
		<b>Adjust Outside Temp. Display</b>	Adjusts the temperature reading by a few degrees.	-3°C ~ ±0°C* <sup>1</sup> ~ +3°C
		<b>“Trip A” Reset Timing</b>	Changes the setting of how to reset trip meter A, average fuel economy A, average speed A, and elapsed time A.	When Refueled/ When Ignition Is Turned Off/Manual Reset* <sup>1</sup>
		<b>“Trip B” Reset Timing</b>	Changes the setting of how to reset trip meter B, average fuel economy B, average speed B, and elapsed time B.	When Refueled/ When Ignition Is Turned Off/Manual Reset* <sup>1</sup>
		<b>Alarm Volume Control</b>	Changes the alarm volume, such as buzzers, warnings, turn signal sound, and so on.	Max/Mid* <sup>1</sup> /Min
		<b>Shift Up Backlight*</b>	Changes whether shift up backlight blinks when the tachometer reading approaches the red zone. <input checked="" type="checkbox"/> Shift Up Backlight*/Shift Up Alarm* P. 160	On* <sup>1</sup> /Off
		<b>Shift Up Alarm*</b>	Changes whether alarm sounds when the tachometer reading approaches the red zone.	On* <sup>1</sup> /Off

\*1:Default Setting

\* Not available on all models

Setup Group	Customizable Features	Description	Selectable Settings	
<b>Vehicle</b>	<b>Meter Setup</b>	<b>Fuel Efficiency Backlight*</b>	Turns the ambient meter feature on and off.	<b>On*<sup>1</sup>/Off</b>
		<b>Auto Idle Stop Display*</b>	Selects whether the Auto Idle Stop guidance screens comes on.	<b>On*<sup>1</sup>/Off</b>
		<b>Turn by Turn Display</b>	Used to select whether the turn-by-turn display comes on during the route guidance.	<b>On*<sup>1</sup>/Off</b>
		<b>New Message Notifications*</b>	Used to select whether a pop-up alert comes on the screen when HFT receives a new text/e-mail message.	<b>On*<sup>1</sup>/Off</b>
		<b>Speed/Distance Units*</b>	Selects the trip computer units.	<b>mph-miles*<sup>1</sup>/ km/h-km</b>
		<b>Tachometer</b>	Selects whether the tachometer comes on the driver information interface.	<b>On*<sup>1</sup>/Off</b>
		<b>Gear Position Display*</b>	Turns the gear position display feature on and off.	<b>On*<sup>1</sup>/Off</b>

\*1:Default Setting



Setup Group	Customizable Features	Description	Selectable Settings
Vehicle	<b>Door Unlock Mode</b>	Changes which doors unlock when you grab the driver's door handle.	<b>Driver Door Only*<sup>1</sup>/ All Doors</b>
	<b>Keyless Access Beep Volume*</b>	Changes the beep volume of unlocking/locking the doors.	<b>High*<sup>1</sup>/Low</b>
	<b>Keyless Access Light Flash</b>	Causes some exterior lights to flash when you unlock/lock the doors.	<b>On*<sup>1</sup>/Off</b>
	<b>Keyless Access Beep*</b>	Causes the beeper to sound when you unlock/lock the doors.	<b>On*<sup>1</sup>/Off</b>

\*1: Default Setting

\* Not available on all models

Setup Group	Customizable Features	Description	Selectable Settings	
Vehicle	Lighting Setup	<b>Interior Light Dimming Time</b>	Changes the length of time the interior lights stay on after you close the doors.	<b>60sec/30sec<sup>*1</sup>/15sec</b>
		<b>Headlight Auto Off Timer</b>	Changes the length of time the exterior lights stay on after you close the driver's door.	<b>60sec/30sec/ 15sec<sup>*1</sup>/0sec</b>
		<b>Auto Light Sensitivity<sup>*</sup></b>	Changes the timing for the headlights to come on.	<b>Max/High/Mid<sup>*1</sup>/ Low/Min</b>
		<b>Instrument Illumination Sensitivity</b>	Changes the sensitivity of the brightness of the instrument panel when the headlight switch is in <b>AUTO</b> .	<b>Min/Low/Mid<sup>*1</sup>/ High/Max</b>
		<b>Headlight Integration With Wipers</b>	Used to automatically come on the headlights when the wipers are used several times within a certain number of intervals with the headlight switch is in <b>AUTO</b> .	<b>On<sup>*1</sup>/Off</b>

\*1:Default Setting

Setup Group	Customizable Features	Description	Selectable Settings	
Vehicle	Door/ Window Setup	<b>Auto Door Lock*</b>	Used to change the setting for when the doors automatically lock.	<b>With Vehicle Speed*<sup>1</sup>/Off</b>
		<b>Auto Door Unlock*</b>	Changes the setting for when the doors unlock automatically.	<b>Driver Door with IGN Off*<sup>1</sup>/All Doors with IGN Off/Off</b>
		<b>Key And Remote Unlock Mode</b>	Sets up the driver's door or all the doors to unlock on the first push of the remote.	<b>Driver Door Only*<sup>1</sup>/All Doors</b>
		<b>Keyless Lock Notification</b>	LOCK/UNLOCK- The exterior lights flash.	<b>On*<sup>1</sup>/Off</b>
		<b>Security Relock Timer</b>	Changes the time it takes for the doors to relock and the security system to set after you unlock the vehicle without opening any door.	<b>90sec/60sec/30sec*<sup>1</sup></b>
		<b>Walk Away Lock*</b>	Changes the settings for the auto lock function when you walk away from the vehicle.	<b>On/Off*<sup>1</sup></b>
		<b>Auto Folding Door Mirror*</b>	Changes how you can fold the door mirrors.	<b>Auto Fold With Keyless*<sup>1</sup>/Manual Only</b>

Features

\*1:Default Setting

\* Not available on all models

►► Customized Features ►

Setup Group	Customizable Features	Description	Selectable Settings
<b>Vehicle</b>	<b>Maintenance Info.</b>	Used to reset the service reminder system information display*/oil monitor system information* when the maintenance service has been performed.	—
	<b>Default</b>	Cancels/Resets all customized items in the <b>Vehicle</b> settings group as default.	<b>Yes/No</b>
<b>Smartphone</b>	<b>Apple CarPlay</b>	Sets up the Apple CarPlay connection.	—
	<b>Android Auto</b>	Sets up the Android Auto connection.	—
	<b>Default</b>	Cancels/Resets all customized items in the <b>Smartphone</b> group as default.	<b>Yes/No</b>

## Defaulting All the Settings

Reset all the menu and customized settings as the factory defaults.

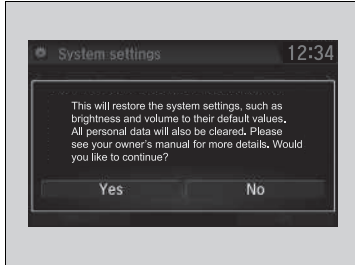

1. Press the  button.
2. Select **Settings**.
3. Select **System**.
4. Select the **Others** tab.
5. Select **Factory Data Reset**.
  - A confirmation message appears on the screen.
6. Select **Yes** to reset the settings.
7. Select **Yes** again to reset the settings.
  - A confirmation message appears on the screen. Select **OK**.
  - After selecting **OK**, the system will reboot.

### ▣ Defaulting All the Settings

When you transfer the vehicle to a third party, reset all settings to default and delete all personal data.

If you perform **Factory Data Reset**, it will reset the preinstalled apps to their factory default.

# Hands-Free Telephone System

## Models with colour audio system

Hands-Free Telephone (HFT) System allows you to place and receive phone calls using your vehicle's audio system, without handling your mobile phone.

## Using HFT

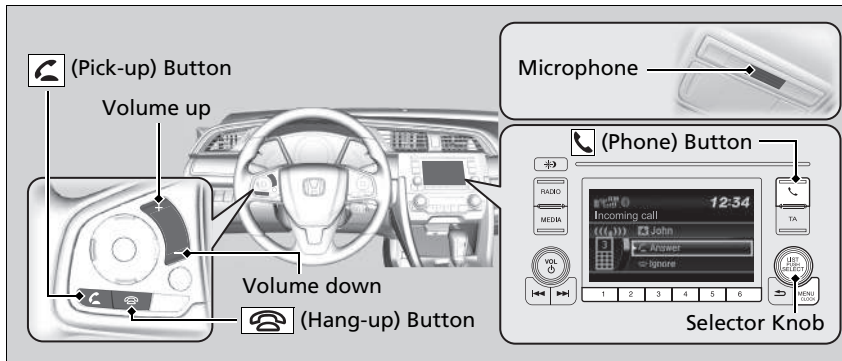

### HFT Buttons



**(Pick-up) button:** Press to go directly to the **Phone** screen or to answer an incoming call.

**(Hang-up) button:** Press to end a call or to cancel a command.

**(Phone) button:** Press to go directly to the **Phone** screen.

**Selector Knob:** Rotate  to select an item on the screen, then press .

### Hands-Free Telephone System

Place your phone where you can get good reception.

To use HFT, you need a *Bluetooth*-compatible mobile phone. For a list of compatible phones, pairing procedures, and special feature capabilities, ask a dealer or your local Honda.

If you receive a call while using the audio system, the system resumes its operation after ending the call.

Up to 20 speed dial entries can be stored. If there is no entry in the system, Speed Dial is disabled.

**Speed Dial** P. 445

Up to 20 call histories can be stored. If there is no call history, Call History is disabled.

## HFT Status Display

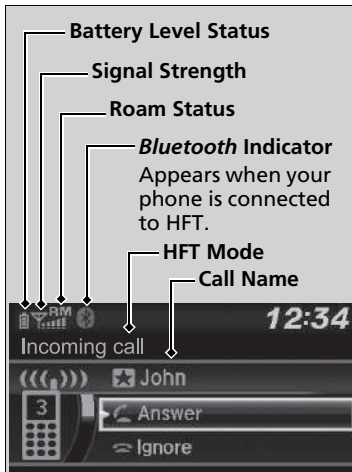

The audio/information screen notifies you when there is an incoming call.

## Limitations for Manual Operation

Certain manual functions are disabled or inoperable while the vehicle is in motion. You cannot select a grayed-out option until the vehicle is stopped.

## Hands-Free Telephone System

### Bluetooth® Wireless Technology

The *Bluetooth*® word mark and logos are registered trademarks owned by Bluetooth SIG, Inc., and any use of such marks by Honda Motor Co., Ltd., is under licence. Other trademarks and trade names are those of their respective owners.

### HFT Limitations

An incoming call on HFT will interrupt the audio system when it is playing. It will resume when the call is ended.

## HFT Status Display

The information that appears on the audio/information screen varies between phone models.

## HFT Menus

The ignition switch must be in ACCESSORY **I** or ON **II** to use HFT.

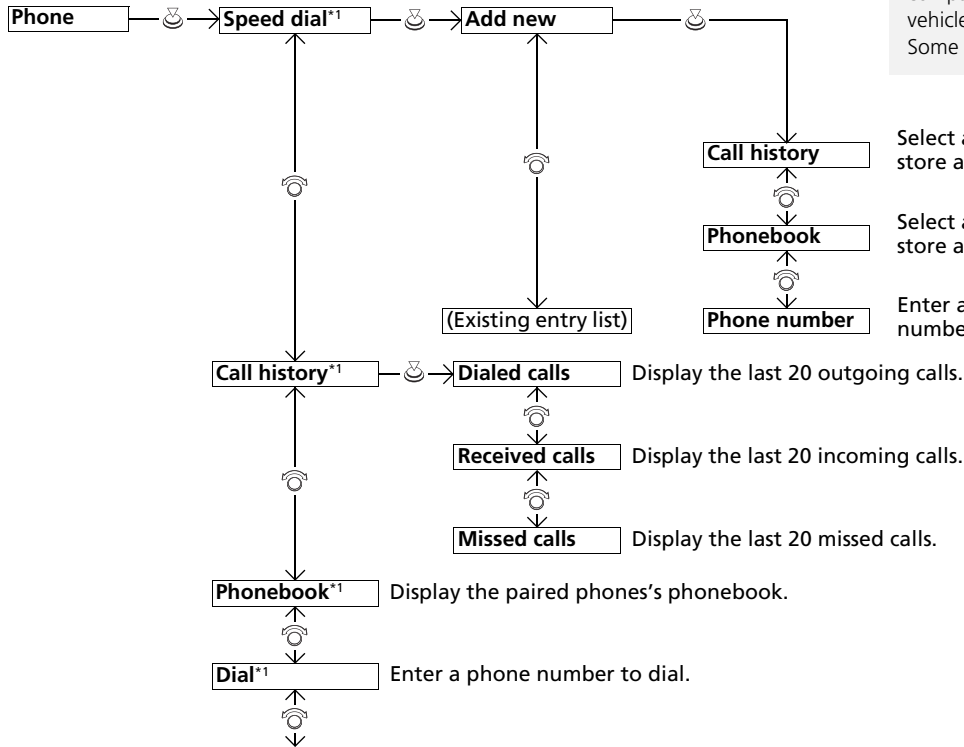
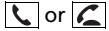

### HFT Menus

To use HFT, you must first pair your *Bluetooth*-compatible mobile phone to the system while the vehicle is parked. Some functions are limited while driving.

Select a phone number from the call history to store as a speed dial number.

Select a phone number from the phonebook to store as a speed dial number.

Enter a phone number to store as a speed dial number.

Display the last 20 outgoing calls.

Display the last 20 incoming calls.

Display the last 20 missed calls.

Display the paired phones's phonebook.

Enter a phone number to dial.

\*1: Appears only when a phone is connected to HFT.



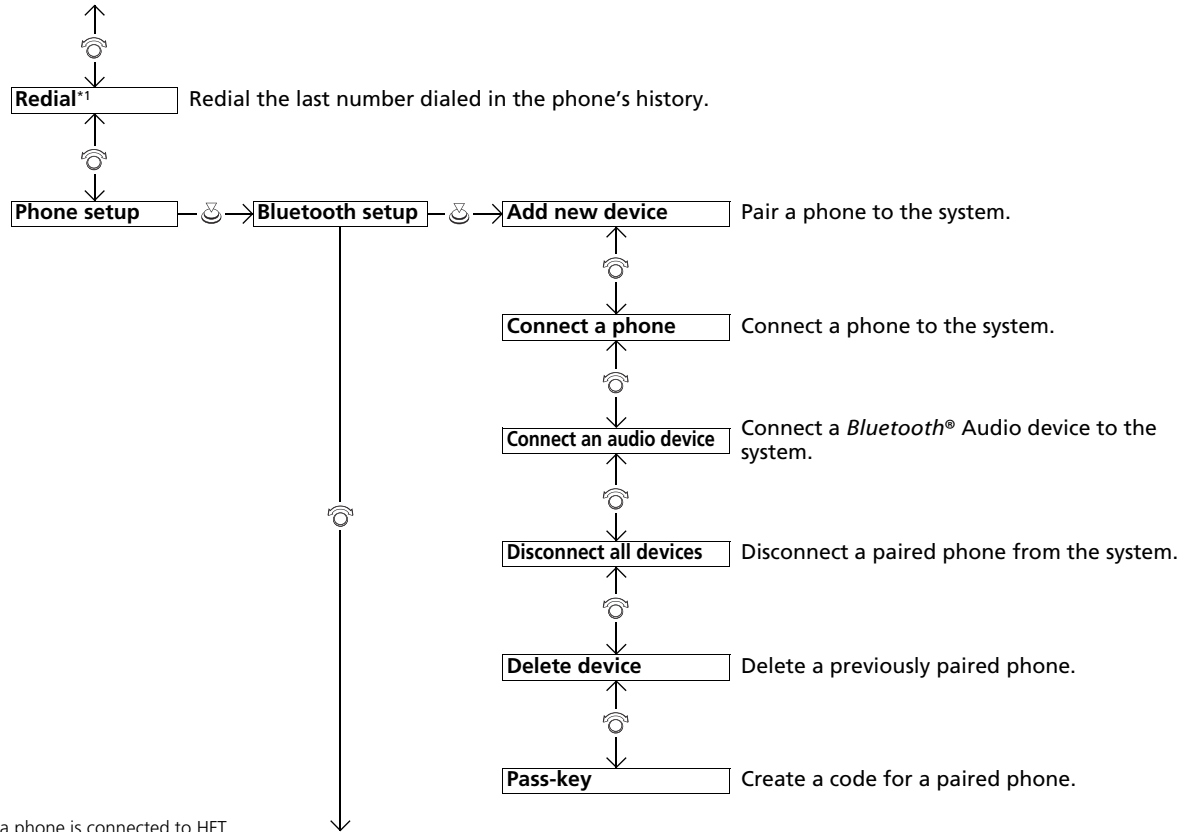

\*1: Appears only when a phone is connected to HFT.

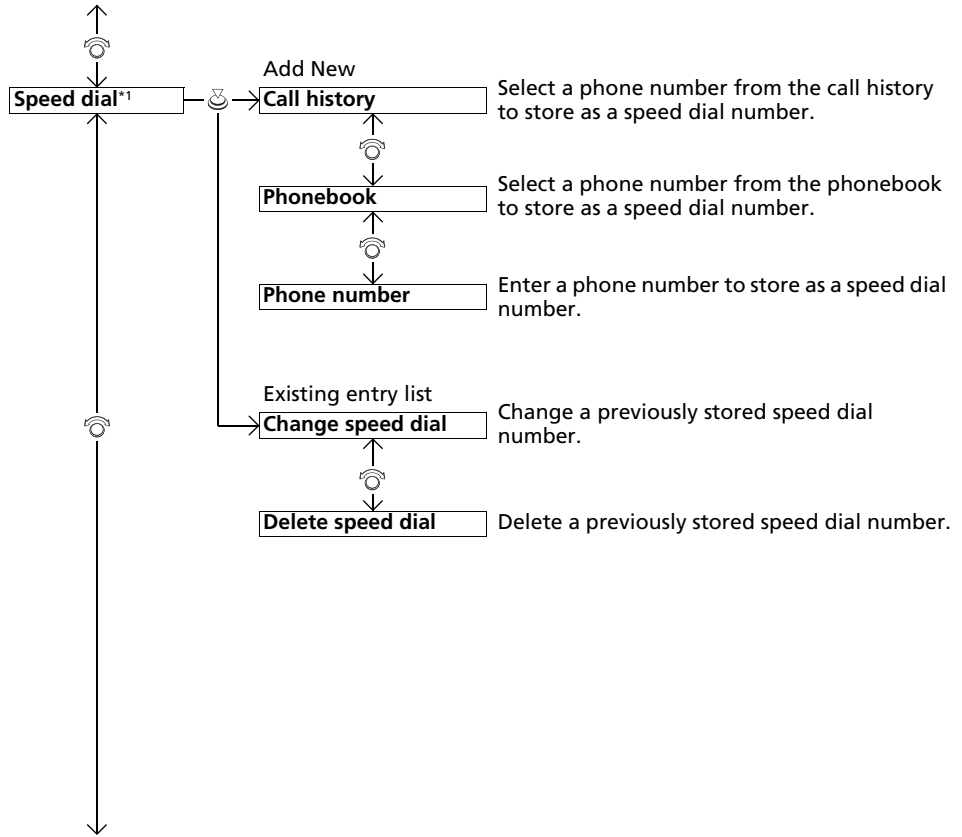

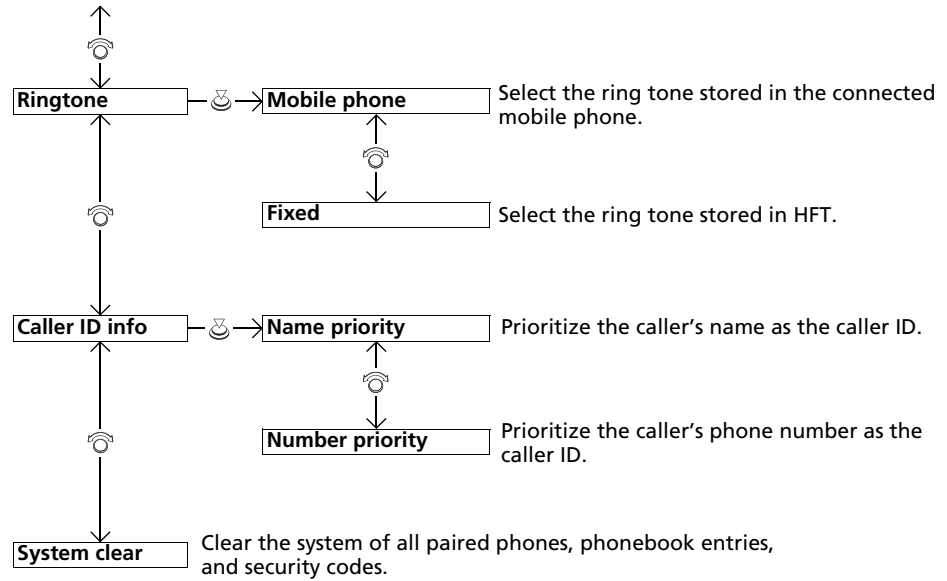

## Phone Setup

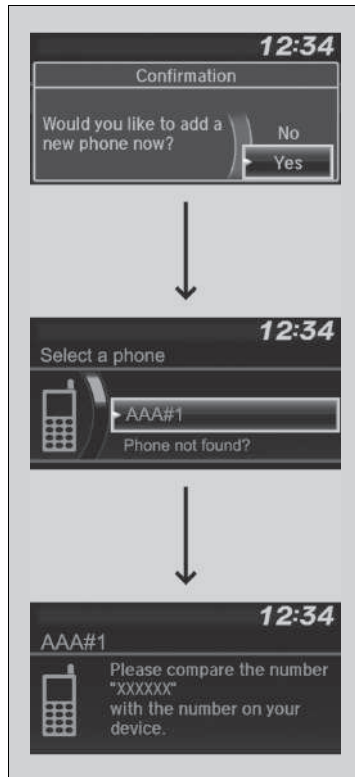

### ■ To pair a mobile phone (No phone has been paired to the system)

1. Press the button or the button.
2. Rotate to select **Yes**, then press .
3. Make sure your phone is in search or discoverable mode, then press .
  - ▶ HFT automatically searches for a *Bluetooth*® device.
4. When your phone appears on the list, select it by pressing .
  - ▶ If your phone doesn't appear, select **Phone not found?** and search for *Bluetooth*® devices using your phone. From your phone, select **Honda HFT**.
5. The system gives you a pairing code on the audio/information screen.
  - ▶ Confirm if the pairing code on the screen and your phone match. This may vary by phone.
6. A notification appears on the screen if pairing is successful.

### ☒ Phone Setup

Your *Bluetooth*-compatible phone must be paired to HFT before you can make and receive hands-free calls.

#### Phone Pairing Tips:

- You cannot pair your phone while the vehicle is moving.
- Up to six phones can be paired.
- Your phone's battery may drain faster when it is paired to HFT.
- If your phone is not ready for pairing or not found by the system within three minutes, the system will time out and return to idle.







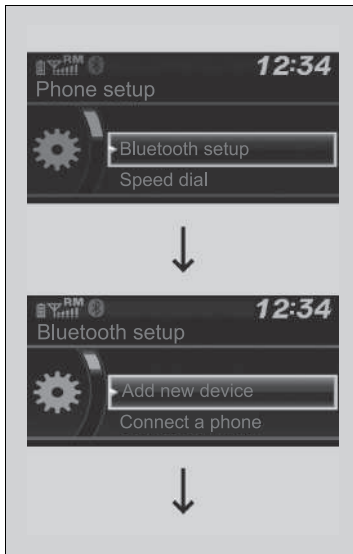

Once you have paired a phone, you can see it displayed on the screen with one or two icons on the right side.

These icons indicate the following:

- : The phone can be used with HFT.
- : The phone is compatible with *Bluetooth*® Audio.

■ **To pair a mobile phone (when a phone has already been paired to the system)**



1. Press the  button or the  button.
  - ▶ If a prompt appears asking to connect to a phone, select **No** and proceed with step 2.
2. Rotate  to select **Phone setup**, then press .
3. Rotate  to select **Bluetooth setup**, then press .
4. Rotate  to select **Add new device**, then press .
  - ▶ The screen changes to device list.

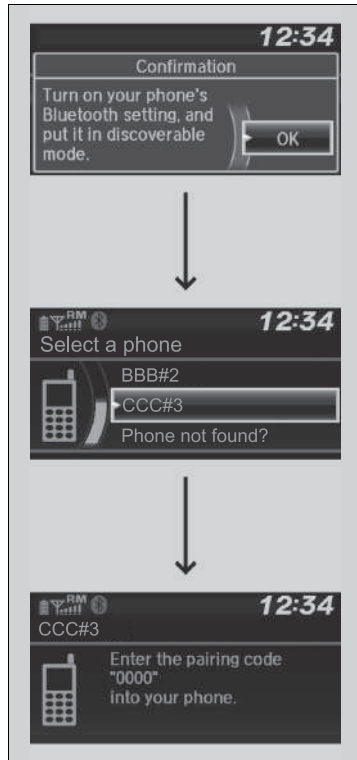

5. Make sure your phone is in search or discoverable mode, then press  .
  - ▶ HFT automatically searches for a *Bluetooth*® device.

6. When your phone appears on the list, select it by pressing  .
  - ▶ If your phone does not appear, select **Phone not found?** and search for *Bluetooth*® devices using your phone. From your phone, select **Honda HFT**.

7. The system gives you a pairing code on the audio/information screen.
  - ▶ Confirm if the pairing code on the screen and your phone match. This may vary by a phone.

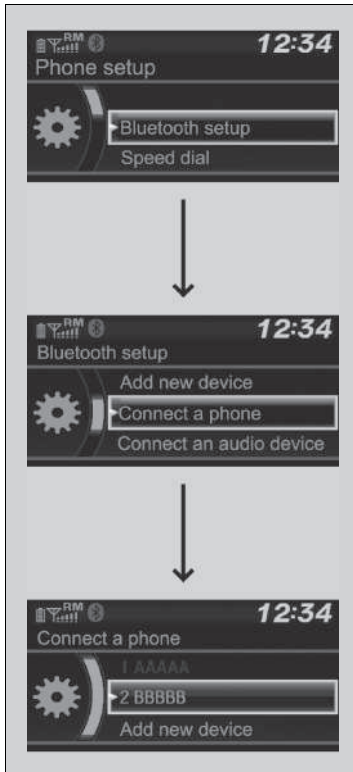

■ **To change the currently paired phone**

1. Press the button or the button.
2. Rotate to select **Phone setup**, then press .
3. Rotate to select **Bluetooth setup**, then press .
4. Rotate to select **Connect a phone**, then press .
  - ▶ The screen changes to a device list.
5. Rotate to select a desired device name, then press .
  - ▶ HFT disconnects the connected phone and starts searching for another paired phone.



■ **To change the pairing code setting**

1. Press the button or the button.
2. Rotate to select **Phone setup**, then press .
3. Rotate to select **Bluetooth setup**, then press .
4. Rotate to select **Pass-key**, then press .
5. Input a new pairing code, then press .



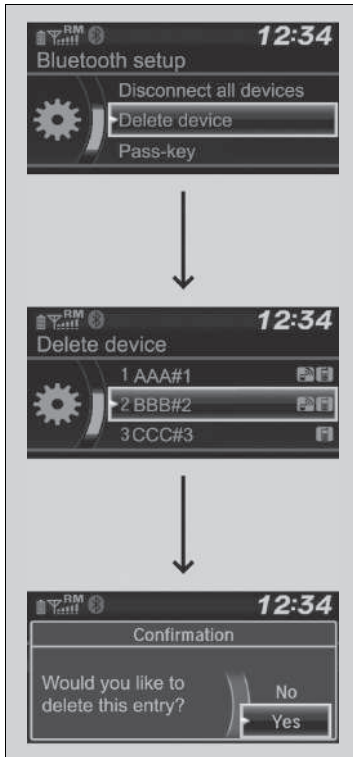

### ■ To delete a paired phone

1. Press the button or the button.
2. Rotate to select **Phone setup**, then press .
3. Rotate to select **Bluetooth setup**, then press .
4. Rotate to select **Delete device**, then press .
  - ▶ The screen changes to a device list.
5. Rotate to select a phone you want to delete, then press .
6. A confirmation message appears on the screen. Rotate to select **Yes**, then press .

## Ring Tone

You can change the ring tone setting.



1. Press the button or the button.
2. Rotate to select **Phone setup**, then press .
3. Rotate to select **Ringtone**, then press .
4. Rotate to select **Fixed** or **Mobile phone**, then press .

## Caller's ID Information

You can select a caller's information to be displayed when you have an incoming call.

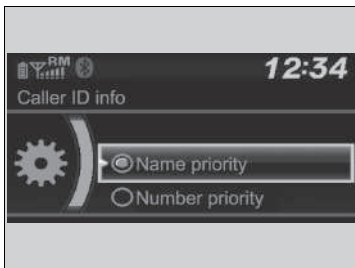

1. Press the button or the button.
2. Rotate to select **Phone setup**, then press .
3. Rotate to select **Caller ID info**, then press .
4. Rotate to select a mode you want, then press .

## Ring Tone

**Fixed:** The fixed ring tone sounds from the speakers.  
**Mobile phone:** Depending on the make and model of the mobile phone, the ring tone stored in the phone will sound if the phone is connected.

## Caller's ID Information

**Name priority:** A caller's name is displayed if it is stored in the phonebook.  
**Number priority:** A caller's phone number is displayed.

## ■ To Clear the System

Pairing codes, paired phones, all speed dial entries, all call history data, and all imported phonebook data are erased.

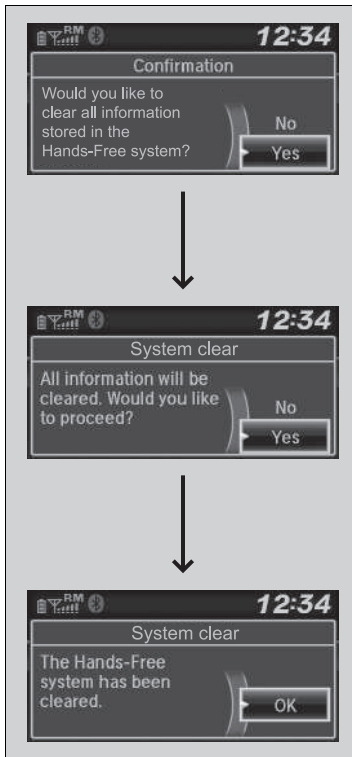

1. Press the button or the button.
2. Rotate to select **Phone setup**, then press .
3. Rotate to select **System clear**, then press .
4. Rotate to select **Yes**, then press .
5. A confirmation message appears on the screen. Rotate to select **Yes**, then press .
6. A notification appears on the screen. Press .

## ■ Automatic Import of Mobile Phonebook and Call History

When your phone is paired, the contents of its phonebook and call history are automatically imported to HFT.

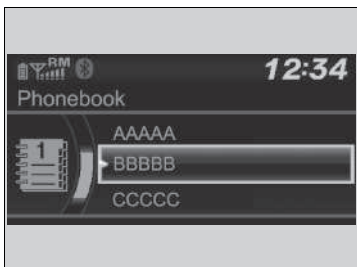

## ☒ Automatic Import of Mobile Phonebook and Call History

When you select a person from the list in the mobile phonebook, you can see up to three category icons. The icons indicate what types of numbers are stored for that name.

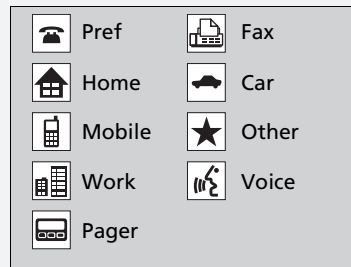

If a name has four or more numbers, ... appears instead of category icons.

On some phones, it may not be possible to import the category icons to HFT.

The phonebook is updated after every connection. Call history is updated after every connection or call.

## ■ Speed Dial

Up to 20 speed dial numbers can be stored per phone.

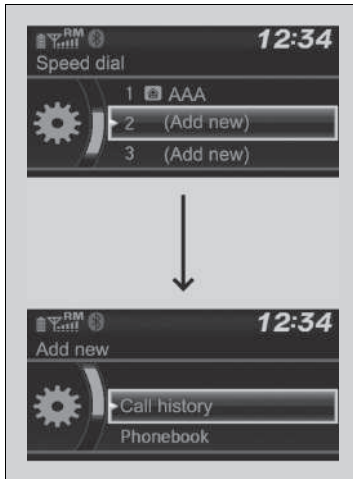

To store a speed dial number:

1. Press the button or the button.
2. Rotate to select **Speed dial**, then press .
3. Rotate to select **Add new**, then press .
4. Rotate to select a place to choose a number from, then press .
  - ▶ From **Call history**:
    - ▶ Select a number from the call history.
  - ▶ From **Phonebook**:
    - ▶ Select a number from the connected mobile phone's imported phonebook.
  - ▶ From **Phone number**:
    - ▶ Input the number manually.

## ▣ Speed Dial

You can use the audio preset buttons during a call to store a speed dial number:

1. Press and hold the desired audio preset button during a call.
2. The contact information for the active call will be stored for the corresponding speed dial.

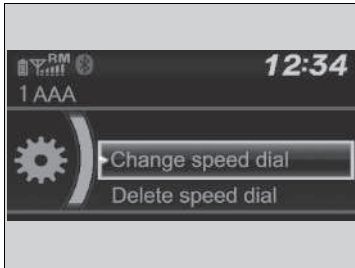

■ **To edit a speed dial**

1. Press the button or the button.
2. Rotate to select **Phone setup**, then press .
3. Rotate to select **Speed dial**, then press .
4. Select an existing speed dial entry.
5. Rotate to select **Change speed dial**, then press .
6. Select a new speed dial number, then press .

■ **To delete a speed dial number**

1. Press the button or the button.
  2. Rotate to select **Phone setup**, then press .
  3. Rotate to select **Speed dial**, then press .
  4. Select an existing speed dial entry.
  5. Rotate to select **Delete speed dial**, then press .
- A confirmation message appears on the screen. Rotate to select **Yes**, then press .

## ■ Making a Call

You can make calls by inputting any phone number, or by using the imported phonebook, call history, speed dial entries, or redial.

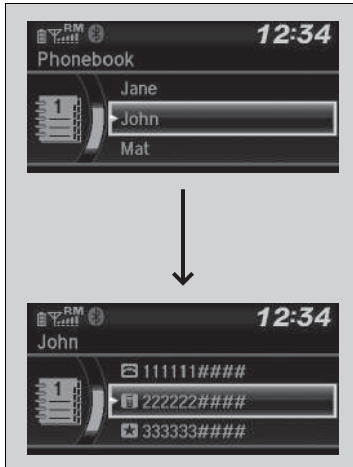
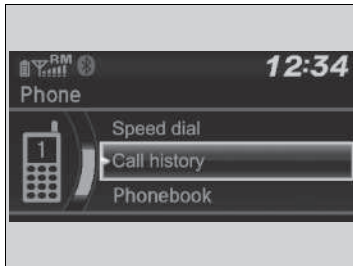

### ■ To make a call using the imported phonebook

When your phone is paired, the contents of its phonebook are automatically imported to HFT.

1. Press the button or the button.
  2. Rotate to select **Phonebook**, then press .
  3. The phonebook is stored alphabetically. Rotate to select the initial, then press .
  4. Rotate to select a name, then press .
  5. Rotate to select a number, then press .
- ▶ Dialing starts automatically.

### ▶▶ Making a Call

Once a call is connected, you can hear the voice of the person you are calling through the audio speakers.

*Continued*

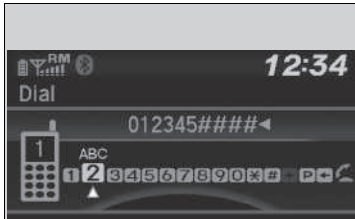

■ **To make a call using a phone number**

1. Press the button or the button.
  2. Rotate to select **Dial**, then press .
  3. Rotate to select a number, then press .
  4. Rotate to select , then press .
- ▶ Dialing starts automatically.

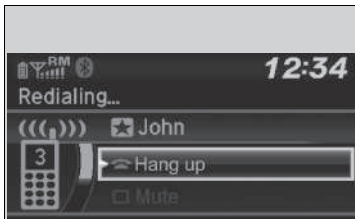

■ **To make a call using redial**

1. Press the button or the button.
  2. Rotate to select **Redial**, then press .
- ▶ Dialing starts automatically.

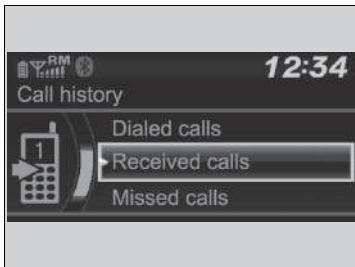

■ **To make a call using the call history**

Call history is stored by **Dialed calls**, **Received calls**, and **Missed calls**.

1. Press the button or the button.
  2. Rotate to select **Call history**, then press .
  3. Rotate to select **Dialed calls**, **Received calls**, or **Missed calls**, then press .
  4. Rotate to select a number, then press .
- ▶ Dialing starts automatically.

ⓧ **To make a call using redial**

Press and hold the button to redial the last number dialed in your phone's call history.

ⓧ **To make a call using the call history**

The call history appears only when a phone is connected to HFT, and displays the last 20 dialed, received, or missed calls.





■ **To make a call using a speed dial entry**

1. Press the button or the button.
2. Rotate to select **Speed dial**, then press .
3. Rotate to select a number, then press .
  - ▶ Dialing starts automatically.

▶▶ To make a call using a speed dial entry

On the **Phone** screen, the first six speed dials on the list can be directly selected by pressing the corresponding audio preset buttons (1-6).

Select **Others** to view another paired phone's speed dial list.

■ **Receiving a Call**

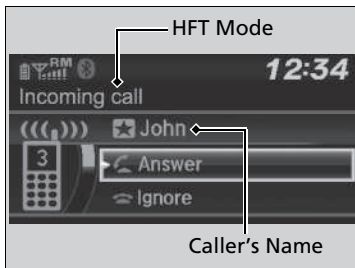

When there is an incoming call, an audible notification sounds and the **Incoming call** screen appears.

- Press the button to answer the call.  
 Press the button to decline or end the call.

▶▶ Receiving a Call

Call Waiting

Press the button to put the current call on hold to answer the incoming call.

Press the button again to return to the current call.

Select **Ignore** to ignore the incoming call if you do not want to answer it.

Press the button if you want to hang up the current call.

You can select the icons on the audio/information screen instead of the and buttons. Rotate to select the icon, then press .

## Options During a Call

The following options are available during a call.

**Swap call:** Put the current call on hold to answer the incoming call.



**Mute:** Mute your voice.

**Transfer call:** Transfer a call from HFT to your phone.

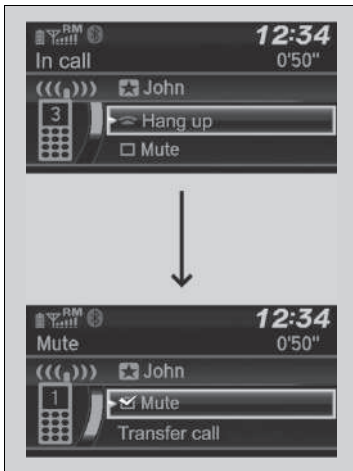
**Dial tones:** Send numbers during a call. This is useful when you call a menu-driven phone system.



1. To view the available options, press the  button.

2. Rotate  to select the option, then press .

▶ The check box is checked when **Mute** is selected. Select **Mute** again to turn it off.

## Options During a Call

**Dial tones:** Available on some phones.

# Hands-Free Telephone System

## Models with Display Audio

Hands-Free Telephone (HFT) System allows you to place and receive phone calls using your vehicle's audio system, without handling your mobile phone.

## Using HFT

### HFT Buttons

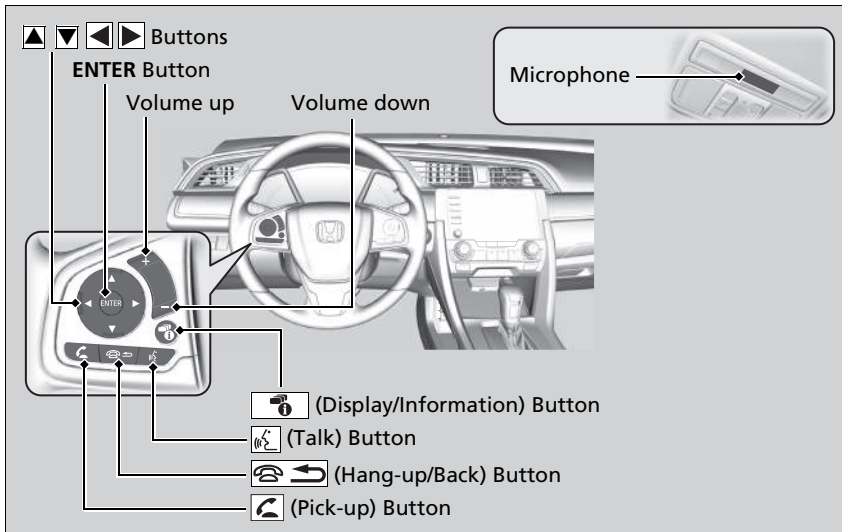

### Hands-Free Telephone System

Place your phone where you can get good reception.

To use HFT, you need a *Bluetooth*-compatible mobile phone. For a list of compatible phones, pairing procedures, and special feature capabilities, ask a dealer or your local Honda.

To use the system, the **Bluetooth On/Off Status** setting must be **On**. If there is an active connection to Apple CarPlay, HFT is unavailable.

➤ **How to customize** P. 396

Voice control tips

- Aim the vents away from the ceiling and close the windows, as noise coming from them may interfere with the microphone.
- Press the  button when you want to call a number using a stored voice tag. Speak clearly and naturally after a beep.
- If the microphone picks up voices other than yours, the command may be misinterpreted.

Up to five speed dial entries can be displayed among a total of 20 that can be entered.

➤ **Speed Dial** P. 465



Up to five previous calls can be displayed at a time among a total of 20 that can be entered. If there is no call history, Call History is disabled.

Continued



 **(Pick-up) button:** Press to go directly to the phone menu on the driver information interface, or to answer an incoming call.

 **(Hang-up/back) button:** Press to end a call, go back to the previous command, or cancel a command.

 **(Talk) button:** Press to access Voice Portal.

  **buttons:** Press to select an item displayed on the phone menu in the driver information interface.

**ENTER button:** Press to call a number listed in the selected item on the phone menu in the driver information interface.

 **(Display/information) button:** Select  and press **ENTER** to display **Speed Dial, Call History, or Phonebook** on the phone menu in the driver information interface.

To go to the **Phone Menu** screen:

1. Press the  button to switch the display to the phone screen.
2. Select **MENU**.

#### Hands-Free Telephone System

##### *Bluetooth*<sup>®</sup> Wireless Technology

The *Bluetooth*<sup>®</sup> word mark and logos are registered trademarks owned by Bluetooth SIG, Inc., and any use of such marks by Honda Motor Co., Ltd., is under licence. Other trademarks and trade names are those of their respective owners.

##### HFT Limitations

An incoming call on HFT will interrupt the audio system when it is playing. It will resume when the call is ended.

## ■ HFT Status Display

The audio/information screen notifies you when there is an incoming call.

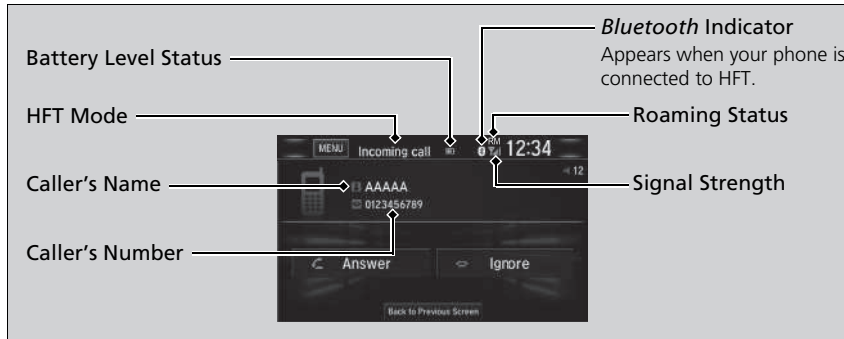

## ■ Limitations for Manual Operation

Certain manual functions are disabled or inoperable while the vehicle is in motion. You cannot select a grayed-out option until the vehicle is stopped.

Only previously stored speed dial entries with voice tags, phonebook names, or numbers can be called using voice commands while the vehicle is in motion.

➤ **Speed Dial** P. 465

## ▣ HFT Status Display

The information that appears on the audio/information screen varies between phone models.

## HFT Menus

The ignition switch must be in ACCESSORY  or ON \*1 to use HFT.

### ■ Phone Settings screen

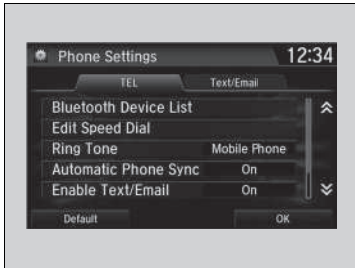

1. Press the  button.
2. Select **Settings**.
3. Select **Phone**.

### ☒ HFT Menu

To use HFT, you must first pair your *Bluetooth*-compatible mobile phone to the system while the vehicle is parked.

Some functions are limited while driving.

Features

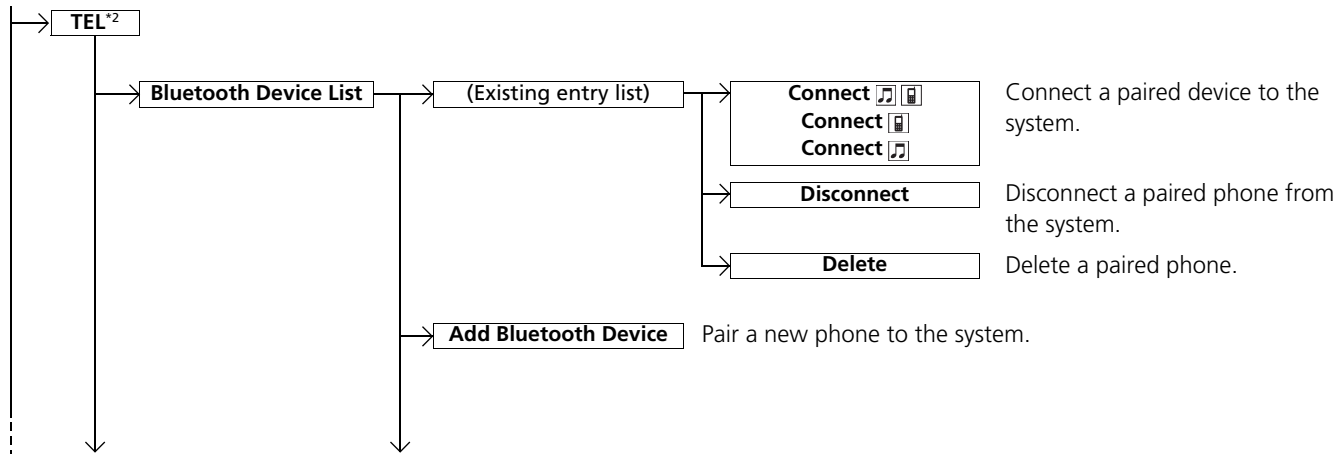

\*1 : Models with the keyless access system have an **ENGINE START/STOP** button instead of an ignition switch.

\*2 : TEL tab is displayed depending on models.

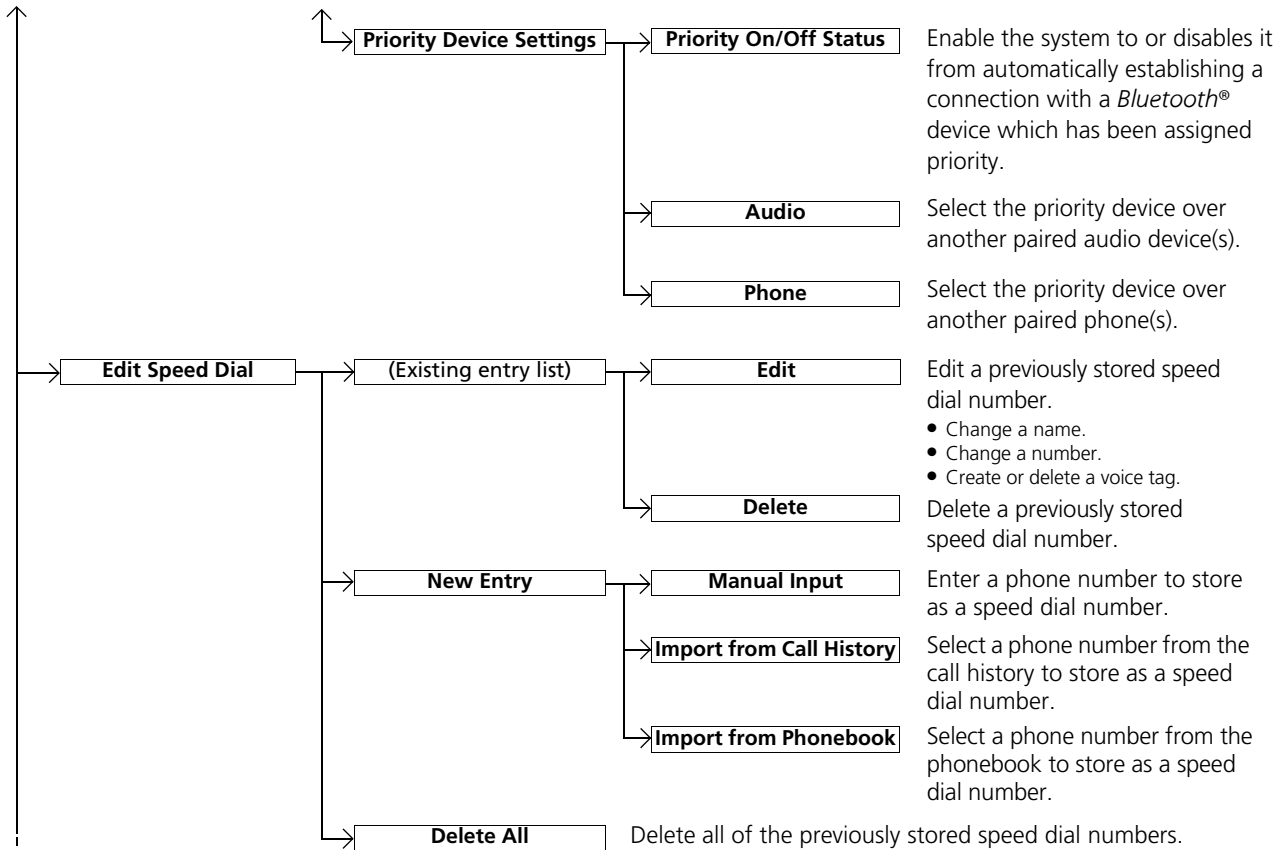

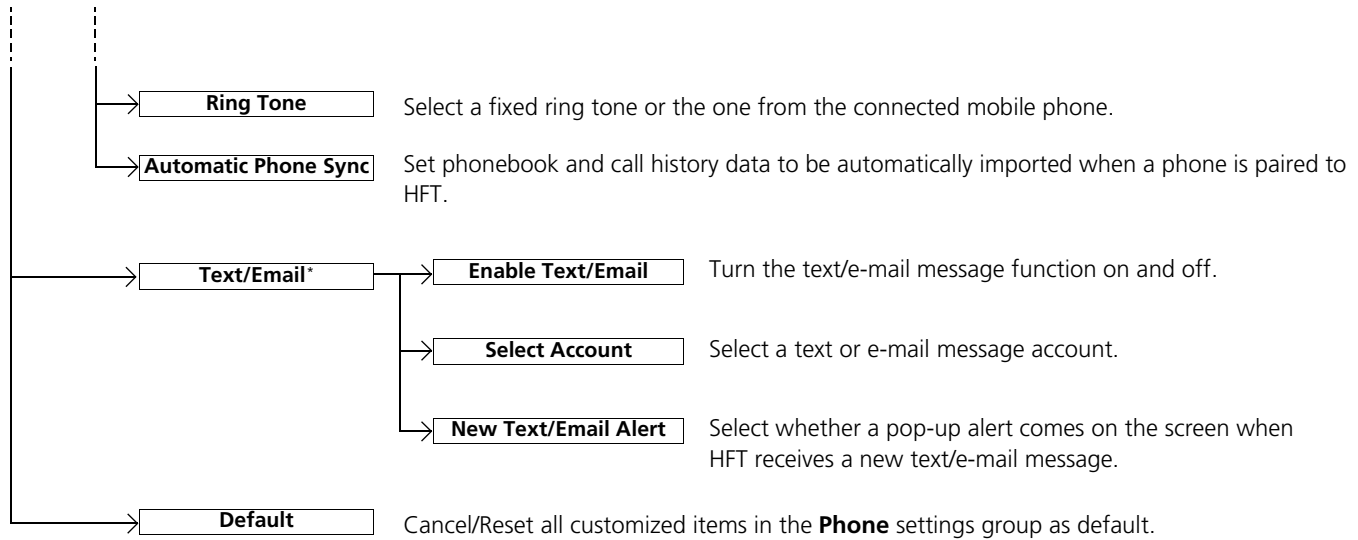



■ Phone Menu screen



1. Press the  button.
2. Select **MENU**.

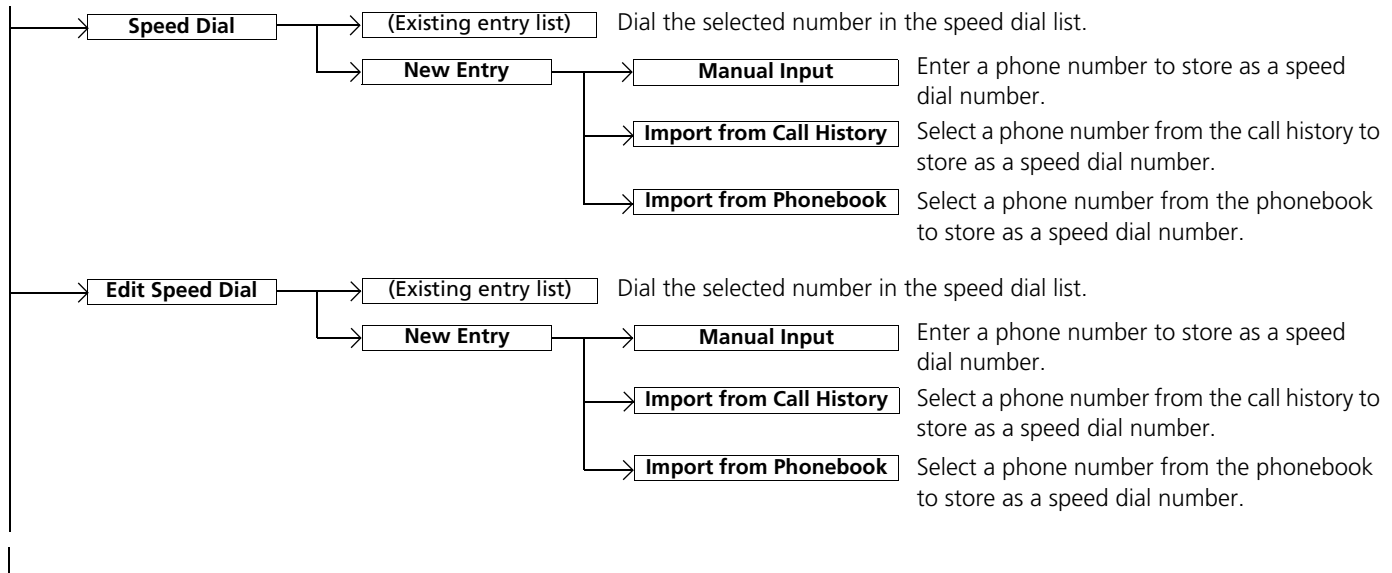

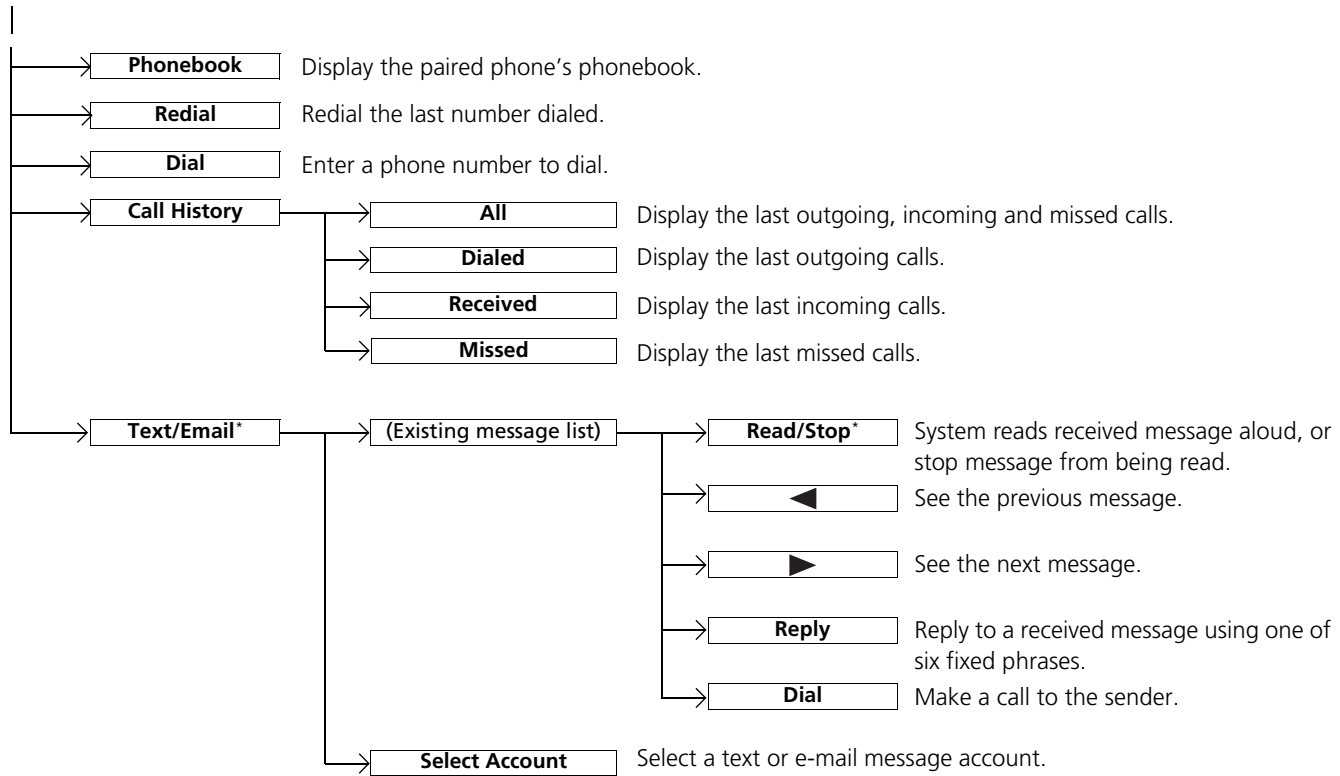

## Phone Setup

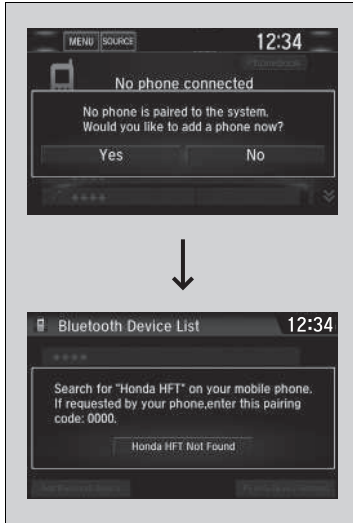

### ■ To pair a mobile phone (when there is no phone paired to the system)

1. Select **Phone**.
2. Select **Yes**.
3. Make sure your phone is in search or discoverable mode.
4. Select **Honda HFT** from your phone.
  - ▶ If you want to pair a phone from this audio system, select **Honda HFT Not Found, Continue**, and then select your phone when it appears on the list. If your phone does not appear, you can select **Refresh** to search again.
5. The system gives you a pairing code on the audio/information screen.
  - ▶ Confirm if the pairing code on the screen and your phone match. This may vary by phone.
6. A notification appears on the screen if pairing is successful.
  - ▶ You can prioritize a *Bluetooth*® device at the same time. Select **Yes** and then a device you want to prioritize.

### ☒ Phone Setup



Your *Bluetooth*-compatible phone must be paired to the system before you can make and receive hands-free calls.

#### Phone Pairing Tips:

- You cannot pair your phone while the vehicle is moving.
- Up to six phones can be paired.
- Your phone's battery may drain faster when it is paired to the system.
- If your phone is not ready for pairing or not found by the system within three minutes, the system will time out and return to idle.

Once you have paired a phone, you can see it displayed on the screen with one or two icons on the right side.



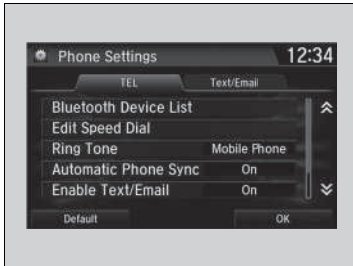

These icons indicate the following:

- : The phone can be used with HFT.
- : The phone is compatible with *Bluetooth*® Audio.

If there is an active connection to Apple CarPlay, pairing of additional *Bluetooth*-compatible devices is unavailable and **Add Bluetooth Device** is grayed out from the **Bluetooth Device List** screen.



### ■ To change the currently paired phone

1. Go to the **Phone Settings** screen.
  - ▶ **Phone Settings screen** P. 454
2. Select **Bluetooth Device List**.
3. Select a phone to connect.
  - ▶ HFT disconnects the connected phone and starts searching for another paired phone.
4. Select **Connect**  , **Connect** , or **Connect** .



### ■ To change the pairing code setting

1. Press the  button.
2. Select **Settings**.
3. Select **Bluetooth / Wi-Fi**.
4. Select the **Bluetooth** tab.
5. Select **Edit Pairing Code**.

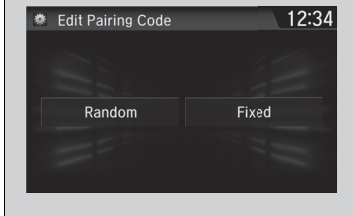

6. Select **Random** or **Fixed**.

### ☒ To change the currently paired phone

If no other phones are found or paired when trying to switch to another phone, HFT will inform you that the original phone is connected again.

To pair other phones, select **Add Bluetooth Device** from the **Bluetooth Device List** screen.

To change the *Bluetooth*<sup>®</sup> connection priority device setting, select **Priority Device Settings** from the **Bluetooth Device List** screen.

### ☒ To change the pairing code setting

The default pairing code is **0000** until you change the setting.

To create your own, select **Fixed**, and delete the current code, then enter a new one.

For a randomly generated pairing code each time you pair a phone, select **Random**.

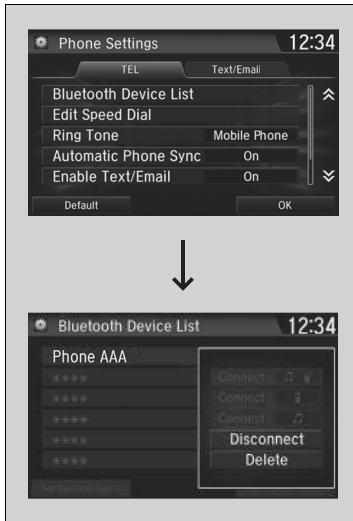

■ **To delete a paired phone**

1. Go to the **Phone Settings** screen.  
 ▶ **Phone Settings screen** P. 454
2. Select **Bluetooth Device List**.
3. Select a phone you want to delete.
4. Select **Delete**.
5. A confirmation message appears on the screen. Select **Yes**.

## ■ To Set Up Text/E-mail Message Options\*

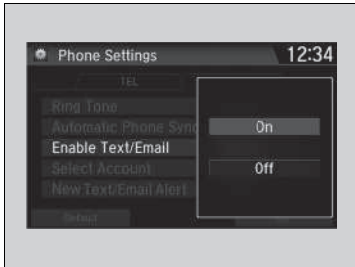

### ■ To turn on or off the text/e-mail message function

1. Go to the **Phone Settings** screen.
  - ▶ **Phone Settings** screen P. 454
2. Select the **Text/Email** tab, then **Enable Text/Email**.
  - ▶ A pop-up menu appears on the screen.
3. Select **On** or **Off**.

### ■ To turn on or off the text/e-mail message notice

1. Go to the **Phone Settings** screen.
  - ▶ **Phone Settings** screen P. 454
2. Select the **Text/Email** tab, then **New Text/Email Alert**.
  - ▶ A pop-up menu appears on the screen.
3. Select **On** or **Off**.

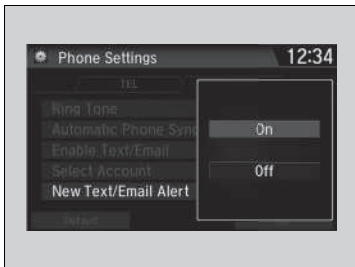

## ☒ To Set Up Text/E-mail Message Options\*

To use the text/e-mail message function, it may be necessary to set up on your phone.

Some text/e-mail message features may not be available depending on a mobile phone.

## ☒ To turn on or off the text/e-mail message notice

**On:** A pop-up notification comes on every time you receive a new message.

**Off:** The message you receive is stored in the system without notification.

## ■ Ring Tone

You can change the ring tone setting.



1. Go to the **Phone Settings** screen.  
▶ **Phone Settings** screen P. 454
2. Select **Ring Tone**.
3. Select **Fixed** or **Mobile Phone**.

## ▣ Ring Tone

**Fixed:** The fixed ring tone sounds from the speakers.  
**Mobile Phone:** Depending on the make and model of the mobile phone, the ring tone stored in the phone will sound if the phone is connected.

*Continued*

## Automatic Import of Mobile Phonebook and Call History

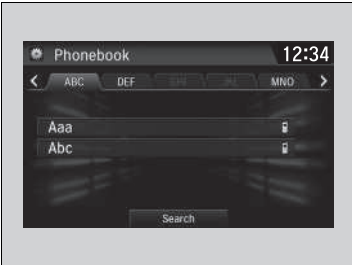

### ■ When Automatic Phone Sync is set to On:

When your phone is paired, the contents of its phonebook and call history are automatically imported to the system.

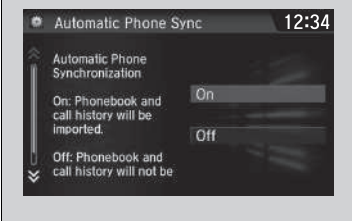
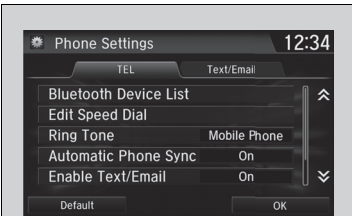

### ■ Changing the Automatic Phone Sync setting

1. Go to the **Phone Settings** screen.

▶ **Phone Settings** screen P. 454

2. Select **Automatic Phone Sync**.

3. Select **On** or **Off**.

### ▶ Automatic Import of Mobile Phonebook and Call History

When you select a name from the list in the mobile phonebook, you can see up to three category icons. The icons indicate what types of numbers are stored for that name.

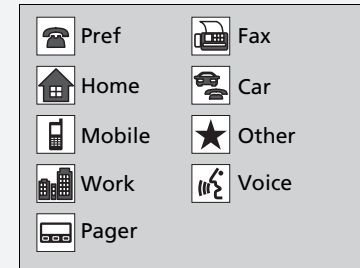

On some phones, it may not be possible to import the category icons to the system.

The phonebook is updated after every connection. Call history is updated after every connection or call.



## ■ Speed Dial

Up to 20 speed dial numbers can be stored per phone.

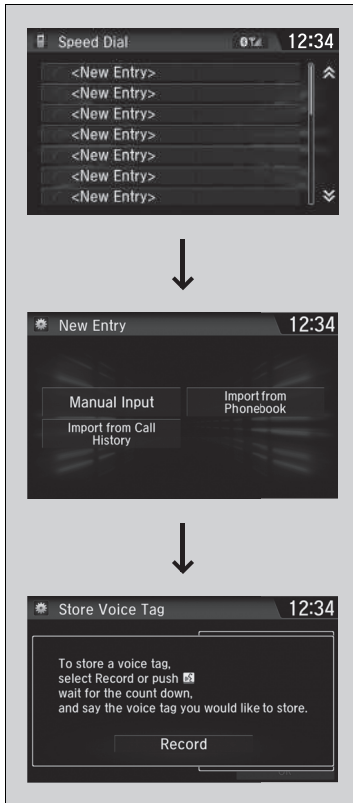

To store a speed dial number:

1. Go to the **Phone Menu** screen.
  - ▶ **Phone Menu** screen P. 457
2. Select **Speed Dial**.
3. Select **New Entry**.
  - From **Import from Call History**:
    - ▶ Select a number from the call history.
  - From **Manual Input**:
    - ▶ Input the number manually.
  - From **Import from Phonebook**:
    - ▶ Select a number from the connected mobile phone's imported phonebook.
4. When the speed dial is successfully stored, you are asked to create a voice tag for the number. Select **Yes** or **No**.
5. Select **Record**, or use the [voice tag icon] button and follow the prompts to complete the voice tag.

## ▣ Speed Dial

When a voice tag is stored, press the [voice tag icon] button to call the number using the voice tag. Say the voice tag name.

*Continued*

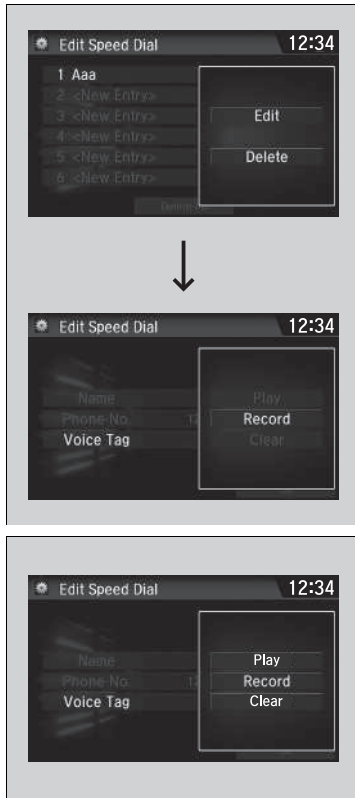

### ■ To add a voice tag to a stored speed dial number

1. Go to the **Phone Settings** screen.
  - **Phone Settings screen** P. 454
2. Select **Edit Speed Dial**.
3. Select an existing speed dial entry.
  - From the pop-up menu, select **Edit**.
4. Select **Voice Tag**.
  - From the pop-up menu, select **Record**.
5. Select **Record**, or use the  button and follow the prompts to complete the voice tag.

### ■ To delete a voice tag

1. Go to the **Phone Settings** screen.
  - **Phone Settings screen** P. 454
2. Select **Edit Speed Dial**.
3. Select an existing speed dial entry.
  - From the pop-up menu, select **Edit**.
4. Select **Voice Tag**.
  - From the pop-up menu, select **Clear**.
5. A confirmation message appears on the screen. Select **Yes**.

### ☒ Speed Dial

Avoid using duplicate voice tags.  
 Avoid using "home" as a voice tag.  
 It is easier for the system to recognise a longer name.  
 For example, use "John Smith" instead of "John."



### ■ To edit a speed dial

1. Go to the **Phone Settings** screen.  
▶ **Phone Settings screen** P. 454
2. Select **Edit Speed Dial**.
3. Select an existing speed dial entry.  
▶ From the pop-up menu, select **Edit**.
4. Select a setting you want.

### ■ To delete a speed dial

1. Go to the **Phone Settings** screen.  
▶ **Phone Settings screen** P. 454
2. Select **Edit Speed Dial**.
3. Select an existing speed dial entry.  
▶ From the pop-up menu, select **Delete**.
4. A confirmation message appears on the screen. Select **Yes**.

## ■ Phonebook Phonetic Modification\*

Add phonetic modifications or a new voice tag to the phone's contact name so that it is easier for HFT to recognize voice commands.

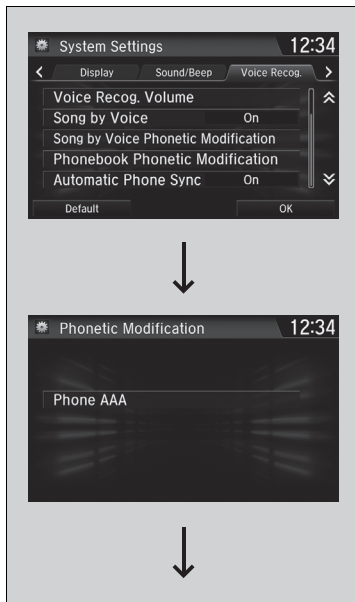

### ■ To add a new voice tag

1. Press the  button.
2. Select **Settings**.
3. Select **System**.
4. Select the **Voice Recog.** tab.
5. Select **Phonebook Phonetic Modification**.
6. Select the phone you want to add phonetic modification to.

### ☑ Phonebook Phonetic Modification\*

You can store up to 20 phonetic modification items.



7. Select **New Voice Tag**.
8. Select a contact name you want to add to.
  - ▶ The pop-up menu appears on the screen.
9. Select **Modify**.
10. Using **Record** or the  button, follow the prompts to complete the voice tag.
11. You will receive a confirmation message on the screen, then select **OK**.

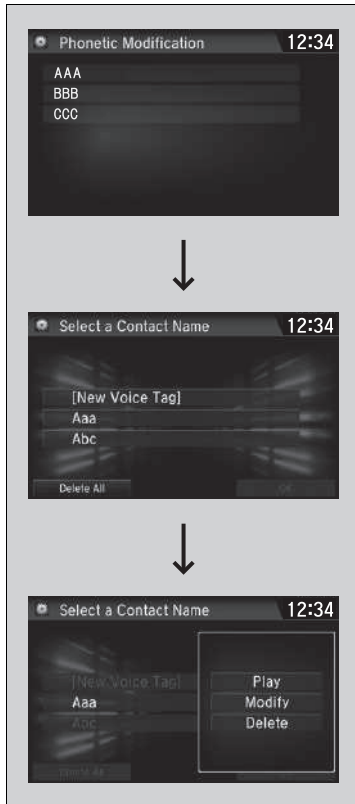

### ■ To modify a voice tag

1. Press the button.
2. Select **Settings**.
3. Select **System**.
4. Select the **Voice Recog.** tab.
5. Select **Phonebook Phonetic Modification**.
6. Select the phone you want to modify phonetic modification.
7. Select a contact name you want to modify.
  - The pop-up menu appears on the screen.
8. Select **Modify**.
9. Using **Record** or the button, follow the prompts to complete the voice tag.
10. You will receive a confirmation message on the screen, then select **OK**.

### ☒ Phonebook Phonetic Modification \*

You can only modify or delete contact names for the currently connected phone.



■ **To delete a modified voice tag**

1. Press the  button.
2. Select **Settings**.
3. Select **System**.
4. Select the **Voice Recog.** tab.
5. Select **Phonebook Phonetic Modification**.
6. Select the phone you want to delete phonetic modification.
7. Select a contact name you want to delete.
  - ▶ The pop-up menu appears on the screen.
8. Select **Delete**.
  - ▶ The selected contact name has been selected.
9. Select **OK**.

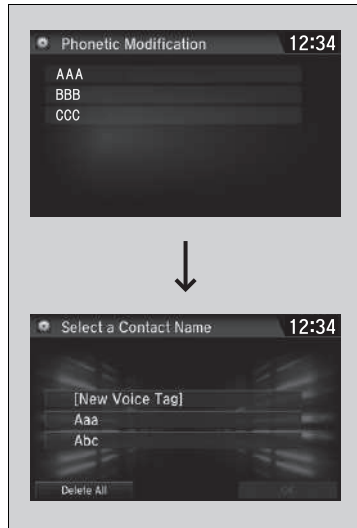

■ **To delete all modified voice tags**

1. Press the button.
2. Select **Settings**.
3. Select **System**.
4. Select the **Voice Recog.** tab.
5. Select **Phonebook Phonetic Modification**.
6. Select the phone you want to delete phonetic modification.
  - The contact name list appears.
7. Select **Delete All**.
8. You will receive a confirmation message on the screen, then select **Yes**.

**Making a Call**



You can make calls by inputting any phone number, or by using the imported phonebook, call history, speed dial entries, or redial.

☒ **Making a Call**

Any voice-tagged speed dial entry can be dialed by voice from most screens.

Press the button and say the voice tag name.

Once a call is connected, you can hear the voice of the person you are calling through the audio speakers.

While there is an active connection with Apple CarPlay, phone calls can be made only from Apple CarPlay.





■ **To make a call using the imported phonebook**

1. Go to the **Phone Menu** screen.  
 ▶ **Phone Menu screen** P. 457
2. Select **Phonebook**.
3. Select a name.  
 ▶ You can also search by letter. Select **Search**.  
 ▶ Use the keyboard on the touch screen for entering a name, if multiple numbers exist select a number.
4. Select a number.  
 ▶ Dialing starts automatically.

■ **To make a call using a phone number**

1. Go to the **Phone Menu** screen.  
 ▶ **Phone Menu screen** P. 457
2. Select **Dial**.
3. Select a number.  
 ▶ Use the keyboard on the touch screen for entering numbers.
4. Select   
 ▶ Dialing starts automatically.

▶▶ To make a call using the imported phonebook

You can call a stored voice-tagged speed dial number using voice commands.

▶ **Speed Dial** P. 465

▶▶ To make a call using a phone number

You can call a stored voice-tagged speed dial number using voice commands.

▶ **Speed Dial** P. 465



■ **To make a call using redial**

1. Go to the **Phone Menu** screen.
  - **Phone Menu screen** P. 457
2. Select **Redial**.
  - ▶ Dialing starts automatically.

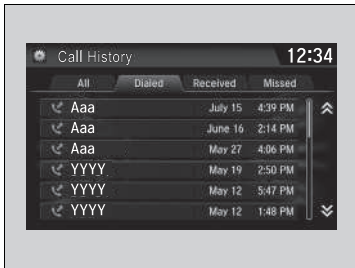

■ **To make a call using the Call History**  
Call history is stored by **All, Dialed, Received, and Missed.**

1. Go to the **Phone Menu** screen.
  - **Phone Menu screen** P. 457
2. Select **Call History**.
3. Select **All, Dialed, Received, or Missed**.
4. Select a number.
  - ▶ Dialing starts automatically.



■ **To make a call using a Speed Dial entry**

1. Go to the **Phone Menu** screen.
  - **Phone Menu screen** P. 457
2. Select **Speed Dial**.
3. Select a number.
  - ▶ Dialing starts automatically.

☒ To make a call using the Call History

The call history displays the last 20 all, dialed, received, or missed calls.  
(Appears only when a phone is connected to the system.)

☒ To make a call using a Speed Dial entry

When a voice tag is stored, press the  button to call the number using the voice tag.

➤ **Speed Dial** P. 465



Any voice-tagged speed dial entry can be dialed by voice from any screen.

Press the  button and follow the prompts.

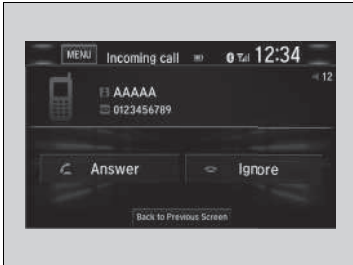
## Receiving a Call



When there is an incoming call, an audible notification sounds (if activated) and the **Incoming call** screen appears.

Press the  button to answer the call.  
Press the  button to decline or end the call.

## Options During a Call

The following options are available during a call.

**Mute:** Mute your voice.

**Transfer:** Transfer a call from the system to your phone.

**Touch Tones:** Send numbers during a call. This is useful when you call a menu-driven phone system.

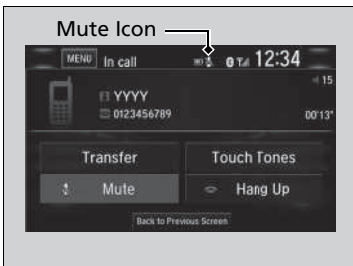

The available options are shown on the lower half of the screen.

Select the option.

- ▶ The mute icon appears when **Mute** is selected. Select **Mute** again to turn it off.

## Receiving a Call



Call Waiting

Press the  button to put the current call on hold to answer the incoming call.

Press the  button again to return to the current call.

Select **Ignore** to ignore the incoming call if you do not want to answer it.

Press the  button if you want to hang up the current call.

You can select the icons on the audio/information screen instead of the  and  buttons.

## Options During a Call

**Touch Tones:** Available on some phones.

You can select the icons on the audio/information screen.

Continued

## Receiving a Text/E-mail Message\*, \*1

HFT can display newly received text or e-mail messages as well as 20 of the most recently received messages on a linked mobile phone. Each received message can be read aloud and replied to using a fixed common phrase.



1. A pop-up appears and notifies you of a new text or e-mail message.
  - The text or e-mail message is displayed.
  - The system automatically starts reading out the message.
2. Select **Read** to listen to the message.
3. To discontinue the message read-out, select **Stop**.

\*1: Message will not be read out depending on the language.

\* Not available on all models

## Receiving a Text/E-mail Message\*, \*1

The system does not display any received messages while you are driving. You can only hear them read aloud.

The system can only receive messages that are sent as text (SMS) messages. Messages sent using data services will not be displayed in the list.

With some phones, you may be able to display up to 20 most recent text and e-mail messages.

Country or local laws may limit your use of the HFT text/e-mail message feature. Only use the text/e-mail message feature when conditions allow you to do so safely.

When you receive a text or e-mail message for the first time since the phone is paired to HFT, you are asked to turn the **New Text/Email Alert** setting to **On**.

► To turn on or off the text/e-mail message notice P. 462

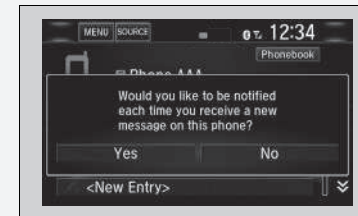

### ■ Selecting a Text/E-mail Message Account\*

If a paired phone has text or e-mail message accounts, you can select one of them to be active and receive notifications.

1. Go to the **Phone Settings** screen.  
 ▶ **Phone Settings** screen P. 454
2. Select the **Text/Email** tab, then **Select Account**.  
 ▶ A pop-up menu appears on the screen.
3. Select **Text Messages** or an e-mail message account you want.

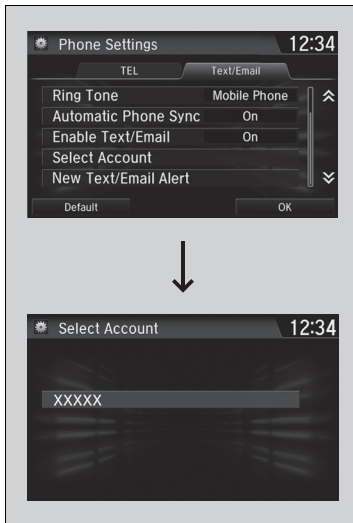

### ▣ Selecting a Text/E-mail Message Account\*

You can also select an e-mail message account from the folder list screen or the message list screen.

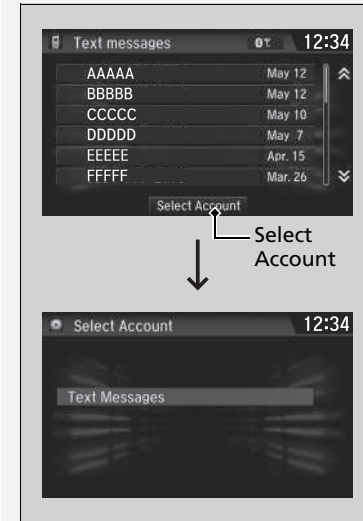

You can only receive notifications from one text or e-mail message account at a time.

\* Not available on all models

Continued

## ■ Displaying Messages\*, \*1

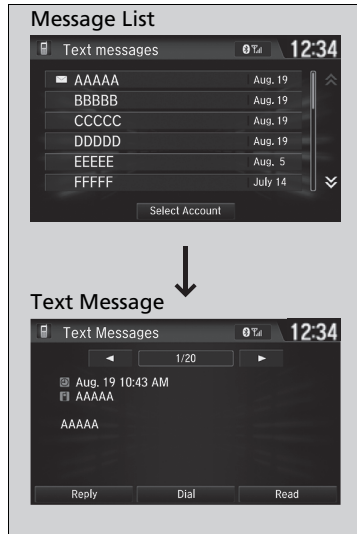



### ■ Displaying text messages

1. Go to the **Phone Menu** screen.
  - ▶ **Phone Menu** screen P. 457
2. Select **Text/Email**.
  - ▶ Select account if necessary.
3. Select a message.
  - ▶ The text message is displayed. The system automatically starts reading the message aloud.

### ☒ Displaying Messages\*, \*1

The  icon appears next to an unread message.

If you delete a message on the phone, the message is also deleted in the system. If you send a message from the system, the message goes to your phone's outbox.

To see the previous or next message, select  (previous) or  (next) on the message screen.

\*1: Message will not be read out depending on the language.

\* Not available on all models

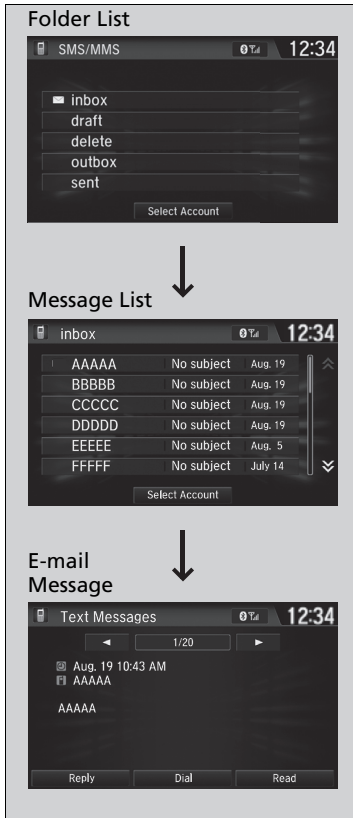

### ■ Displaying e-mail messages

1. Go to the **Phone Menu** screen.
  - ▶ **Phone Menu screen** P. 457
2. Select **Text/Email**.
  - ▶ Select **Select Account** if necessary.
3. Select a folder.
4. Select a message.
  - ▶ The e-mail message is displayed. The system automatically starts reading the message aloud.

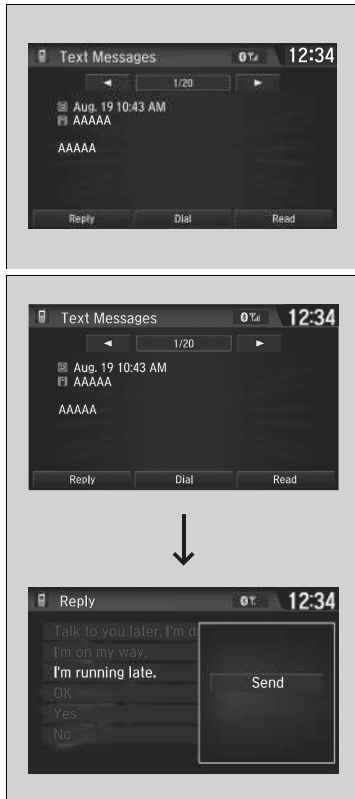

### ■ Read or Stop reading a message

1. Go to the text or e-mail message screen.
  - The system automatically starts reading the message aloud.
  - **Displaying Messages\***, \*1 P. 478
2. Select **Stop** to stop reading.  
Select **Read** again to start reading the message from the beginning.

### ■ Reply to a message

1. Go to the text or e-mail message screen.
  - The system automatically starts reading the message aloud.
  - **Displaying Messages\***, \*1 P. 478
2. Select **Reply**.
3. Select the reply message.
  - The pop-up menu appears on the screen.
4. Select **Send** to send the message.
  - **Message sent** appears on the screen when the reply message was successfully sent.

#### ☒ Reply to a message

The available fixed reply messages are as follows:

- **Talk to you later, I'm driving.**
- **I'm on my way.**
- **I'm running late.**
- **OK**
- **Yes**
- **No**

You cannot add, edit, or delete reply messages.

Only certain phones receive and send messages when paired and connected. For a list of compatible phones ask a dealer.



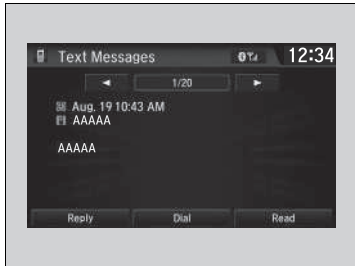

■ **Making a call to a sender**

1. Go to the text message screen.
2. Select **Dial**.



# Driving

This chapter discusses driving and refueling.



<b>Before Driving</b> .....	484
<b>Towing a Trailer</b> .....	488
<b>When Driving</b>	
Starting the Engine .....	493, 496
Precautions While Driving.....	499
Continuously Variable Transmission* .....	501
Shifting .....	502, 504, 509
ECON Mode* .....	513
Auto Idle Stop.....	514, 520
<b>2.0 L engine models</b>	
Drive Mode Switch.....	526
Adaptive Damper System* .....	528
Cruise Control* .....	529
Adjustable Speed Limiter.....	533
Intelligent Speed Limiter.....	537

Vehicle Stability Assist (VSA) System ..	544
Agile Handling Assist .....	547
<b>2.0 L engine models</b>	
Limited Slip Differential (LSD) .....	548
Deflation Warning System.....	549, 553
Blind spot information System* .....	556
LaneWatch* .....	559
Adjusting Headlight Distribution .....	561
<b>Honda Sensing*</b> .....	562
Collision Mitigation Braking System (CMBS) .....	565
<b>Continuously variable transmission models</b>	
Adaptive Cruise Control (ACC) with Low Speed Follow .....	576

<b>Manual transmission models</b>	
Adaptive Cruise Control (ACC) .....	593
Lane Keeping Assist System (LKAS) ..	609
Road Departure Mitigation System... ..	617
Traffic Sign Recognition System .....	623
Front Sensor Camera .....	630
Radar Sensor .....	632
<b>Braking</b> .....	633
<b>Parking Your Vehicle</b> .....	642
<b>Multi-View Rear Camera*</b> .....	653
<b>Refueling</b> .....	655
<b>Fuel Economy and CO<sub>2</sub> Emissions</b> .....	659
<b>Turbo Engine Vehicle</b> .....	660

\* Not available on all models

# Before Driving

## Driving Preparation

Check the following items before you start driving.

### Exterior Checks

- Make sure there are no obstructions on the windows, door mirrors, exterior lights, or other parts of the vehicle.
  - ▶ Remove any frost, snow, or ice.
  - ▶ Remove any snow on the roof, as this can slip down and obstruct your field of vision while driving. If frozen solid, remove ice once it has softened.
  - ▶ When removing ice from around the wheels, be sure not to damage the wheel or wheel components.
- Make sure the bonnet is securely closed.
  - ▶ If the bonnet opens while driving, your front view will be blocked.
- Make sure the tyres are in good condition.
  - ▶ Check air pressures, and check for damage and excessive wear.
    - ▣ **Checking and Maintaining Tyres** P. 716
- Make sure there are no people or objects behind or around the vehicle.
  - ▶ There are blind spots from the inside.

### Exterior Checks

#### NOTICE

When doors are frozen shut, use warm water around the door edges to melt any ice. Do not try to force them open, as this can damage the rubber trim around the doors. When done, wipe dry to avoid further freezing.

Do not pour warm water into the key cylinder. You will be unable to insert the key if the water freezes in the hole.

Heat from the engine and exhaust can ignite flammable materials left under the bonnet, causing a fire. If you've parked your vehicle for an extended period, inspect and remove any debris that may have collected, such as dried grass and leaves that have fallen or have been carried in for use as a nest by a small animal. Also check under the bonnet for leftover flammable materials after you or someone else has performed maintenance on your vehicle.

## ■ Interior Checks

- Store or secure all items on board properly.
  - ▶ Carrying too much luggage, or improperly storing it, can affect your vehicle's handling, stability, stopping distance, and tyres, and make it unsafe.
    - ✎ **Load Limit** P. 487
- Do not pile items higher than the seat height.
  - ▶ They can block your view and may be thrown forward in the event of sudden braking.
- Do not place anything in the front seat footwells. Make sure to secure the floor mat.
  - ▶ An object or unsecured floor mat can interfere with your brake and accelerator pedal operation while driving.
- If you have any animals on board, do not let them move around in the vehicle.
  - ▶ They may interfere with driving and a crash could occur.
- Securely close all doors and the hatch.
- Adjust your seating position properly.
  - ▶ Adjust the head restraint\*, too.
    - ✎ **Adjusting the Seats** P. 243
    - ✎ **Adjusting the Front Head Restraints Positions** P. 246
- Adjust the mirrors and steering wheel properly.
  - ▶ Adjust them while sitting in the proper driving position.
    - ✎ **Adjusting the Mirrors** P. 240
    - ✎ **Adjusting the Steering Wheel** P. 239

## ✎ Interior Checks

The headlight aim is set by the factory, and does not need to be adjusted. However, if you regularly carry heavy items in the luggage area or tow a trailer\*, have the aiming readjusted at a dealer or by a qualified technician.

Your vehicle is equipped with the automatic headlight adjusting system that automatically adjusts the vertical angle of the low beam headlights.

\* Not available on all models

- Be sure items placed on the floor behind the front seats cannot roll under the seats.
  - ▶ They can interfere with the driver's ability to operate the pedals, or the operation of the seats.
- Everyone in the vehicle must fasten their seat belt.
  - **Fastening a Seat Belt** P. 52
- Make sure that the indicators in the instrument panel come on when you start the vehicle, and go off soon after.
  - ▶ Always have a dealer check the vehicle if a problem is indicated.
    - **Indicators** P. 108

## Load Limit

When you load luggage, the total weight of the vehicle, all passengers, and luggage must not exceed the maximum permissible weight.

➤ **Specifications** P. 804

### Load Limit

#### **WARNING**

Overloading or improper loading can affect handling and stability and cause a crash in which you can be hurt or killed.

Follow all load limits and other loading guidelines in this manual.

# Towing a Trailer

1.0 L engine models with heating system

1.5 L engine models

2.0 L engine models

Your vehicle is not designed to tow a trailer. Attempting to do so can void your warranties.

1.0 L engine models with climate control system

## Towing Preparation

### Towing Load Limits

Your vehicle can tow a trailer if you carefully observe the load limits, use the proper equipment, and follow the towing guidelines. Check the load limits before driving.

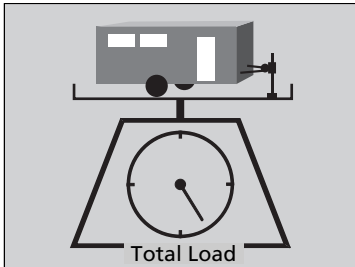

#### ■ Total trailer weight

Do not exceed the maximum towing weight of the trailer and towbar (with/without brakes), luggage and everything in or on it.

Towing loads in excess of the maximum towing weight can seriously affect vehicle handling and performance and can damage the engine and drivetrain.

### ➤ Towing Load Limits

## ⚠ WARNING

Exceeding any load limit or improperly loading your vehicle and trailer can cause a crash in which you can be seriously hurt or killed.

Check the loading of your vehicle and trailer carefully before starting to drive.

Check if all loads are within limits at a public scale. If a public scale is not available, add the estimated weight of your luggage load to the weight of your trailer (as quoted by the manufacturer), and then measure the tongue load with an appropriate scale or tongue gauge or estimate it based on luggage distribution.

Refer to the trailer owner's manual for additional information.

Break-in Period.

Avoid towing a trailer during your vehicle's first 1,000 km (600 miles).



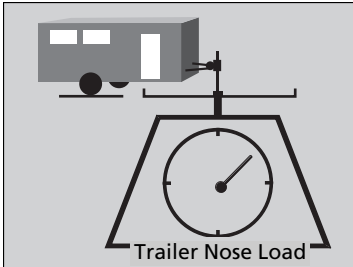

### ■ Trailer nose load

The trailer nose load should never exceed 75 kg (165 lbs). This is the amount of weight the trailer puts on the towbar when it is fully-loaded. As a rule of thumb for trailer weights of less than 750 kg (1,653 lbs), the trailer nose load should be 10 percent of the total trailer package.

- Excessive trailer nose load reduces front tyre traction and steering control. Too little trailer nose load can make the trailer unstable and cause it to sway.
- To achieve a proper trailer nose load, start by loading 60% of the load towards the front of the trailer and 40% towards the rear. Readjust the load as needed.

### ▣ Towing Load Limits

If you tow a trailer in mountainous conditions, remember to reduce 10% of the combined vehicle weights from the maximum towing weight for every 1,000 metres of elevation.

Never exceed the maximum towing weight and specified load limit.

▣ **Specifications** P. 804

*Continued*

## ■ Towing Equipment and Accessories

Towing equipment varies by the size of your trailer, how much load you are towing, and where you are towing.

### ■ Towbars

The towbar must be of an approved type and properly bolted to the underbody.

### ■ Safety chains

Always use safety chains when you tow a trailer. Leave enough slack to allow the trailer to turn corners easily, but do not allow the chains to drag on the ground.

### ■ Trailer brakes

If you are thinking of getting a trailer that has brakes, be sure they are electronically actuated. Do not attempt to tap into your vehicle's hydraulic system. No matter how successful it may seem, any attempt to attach trailer brakes to your vehicle's hydraulic system will lower braking effectiveness and create a potential hazard.

### ■ Additional towing equipment

There may be laws requiring special outside mirrors when towing a trailer. Even if mirrors are not required in your locale, you should install special mirrors if visibility is restricted in any way.

### ■ Trailer light

Trailer lights and equipment must comply with the regulations of the country where you are driving. Check with your local trailer sales or rental agency for the requirements in the area where you plan to tow.

## ☒ Towing Equipment and Accessories

Make sure that all equipment is properly installed and maintained, and that it meets the regulations of the country where you are driving.

Consult your trailer maker for proper installation and setup of the equipment.

Improper installation and setup can affect the handling, stability, and braking performance of your vehicle.

Consult your trailer sales or rental agency if any other items are recommended or required for your towing situation.

The lighting and wiring of trailers can vary by type and brand. If a connector is required, it should only be installed by a qualified technician.

## Driving Safely with a Trailer\*

### ■ Things You Need To Know Before Towing a Trailer

- Have the trailer properly serviced and keep it in good condition.
- Make sure that all the weights and load in the vehicle and trailer are within limits.
  - **Towing Load Limits** P. 488
- Securely attach the towbar, safety chains, and other necessary parts to the trailer.
- Securely store all the items in and on the trailer so that they do not shift while driving.
- Check if the lights and brakes on the trailer are working properly.
- Check the pressure of the trailer tyres, including the spare.
- Check regulations concerning the maximum speed or driving restrictions for vehicles towing trailers. If you are driving across several countries, check each country's requirements before leaving home, because regulations may vary.
- Turn off the Auto Idle Stop system using the Auto Idle Stop **OFF** button. The trailer weight can affect your vehicle's brake effectiveness if Auto Idle Stop is activated on a hill while towing a trailer.

### ■ Towing Speeds and Gears

- Drive slower than normal.
- Obey posted speed limits for vehicles with trailers.

#### Continuously variable transmission models

- Use the **D** position when towing a trailer on level roads.

#### Manual transmission models

Either shift up or shift down indicator will come on at the best time to shift to a higher or lower gear for the better fuel economy.

\* Not available on all models

### » Driving Safely with a Trailer\*

Operating speed when towing a trailer must not exceed 100 km/h (62 mph).

#### Parking

In addition to the normal precautions, place wheel chocks at each of the trailer's tyres.

We recommend you drive uphill of less than 12% slope. Follow the trailer association's recommendations for suitable roads.

Winds caused by passing large vehicles can sway your trailer, keep a constant speed and steer straight ahead.

Always drive slowly and have someone guide you when reversing.

### » Towing Speeds and Gears

When towing a fixed-sided trailer (e.g., camper), do not exceed 88 km/h (55 mph). At higher speeds, the trailer may sway or affect vehicle handling.

Continued

## ■ Turning and Braking

- Turn more slowly and with a wider turning arc than normal.
- Allow more time and distance for braking.
- Do not brake or turn suddenly.

## ■ Driving in Hilly Terrain

- Monitor your temperature gauge. If it nears the upper level, turn off the climate control system and reduce speed. Pull to the side of the road safely to cool down the engine if necessary.

### Continuously variable transmission models

- Shift to the **[S]** position and use the paddle shifter\* to shift down when driving down hills.  
This helps to increase engine braking efficiently and prevent the brake system from overheating.

## ⌘ Towing Speeds and Gears

The shift down indicator\* will not prompt to downshift to 1st gear. It is up to you to downshift to 1st gear to increase engine braking. Avoid sudden engine braking.

Road and traffic conditions may require you to shift at times other than those indicated.

## ⌘ Driving in Hilly Terrain

### Continuously variable transmission models with 5 positions

If you use the paddle shifters when driving uphill and downhill, select 3rd, 2nd, or 1st gear, depending on the vehicle speed and road conditions. Do not use 4th and 5th gears.

# When Driving

Models without keyless access system

## Starting the Engine

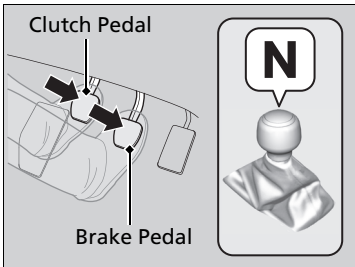
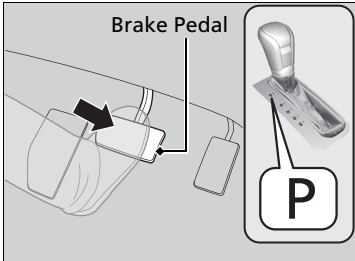

1. Make sure the parking brake is applied.
  - ▶ The parking brake and brake system indicator (red) comes on for 15 seconds when you pull up the electric parking brake switch.

### Continuously variable transmission models

2. Check that the transmission is in **P**, then depress the brake pedal.
  - ▶ Although it is possible to start the vehicle in **N**, it is safer to start it in **P**.

### Manual transmission models

2. Check that the shift lever is in **N**. Then depress the brake pedal with your right foot, and the clutch pedal with your left foot.
  - ▶ The clutch pedal must be fully depressed to start the engine.

### Starting the Engine

Keep your foot firmly on the brake pedal when starting the engine.

The engine is harder to start in cold weather and in thinner air found at altitudes above 2,400 metres (8,000 feet).

When starting the engine in cold weather, turn off all electrical accessories such as the lights, heating system\*/climate control system\*, and rear demister in order to reduce battery drain.

If exhaust system sounds abnormal or you can smell exhaust gas inside the vehicle, have your vehicle checked by a dealer. There may be a problem with the engine or exhaust system.

\* Not available on all models

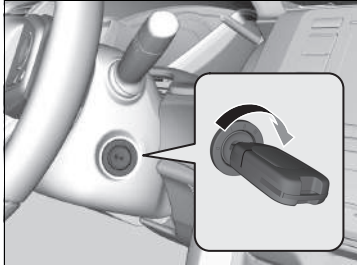

**All models**

3. Turn the ignition switch to START  without depressing the accelerator pedal.

**Starting the Engine**

Do not hold the key in START  for more than 10 seconds.

- If the engine does not start right away, wait for at least 30 seconds before trying again.
- If the engine starts, but then immediately stops, wait at least 30 seconds before repeating step 3 while gently depressing the accelerator pedal. Release the accelerator pedal once the engine starts.

Do not wait until the engine starts with the key in START .

The immobilizer system protects your vehicle from theft. If an improperly coded device is used, the engine's fuel system is disabled.

 **Immobilizer System** P. 207

## ■ Starting to Drive

### Continuously variable transmission models

1. Keeping your right foot on the brake pedal, put the transmission into **[D]**. Select **[R]** when reversing.
2. With the parking brake applied, release the brake pedal and gently depress the accelerator pedal.
  - ▶ Make sure the parking brake and brake system indicator (red) goes off.
  - 🔧 **Parking Brake** P. 633

### ■ Hill start assist system

Hill start assist keeps the brake engaged briefly to help to prevent the vehicle from rolling on inclines as you move your foot from the brake pedal to the accelerator.

### Continuously variable transmission models

Put the transmission into **[D]**, **[S]** or **[L]**\* when facing uphill, or **[R]** when facing downhill, then release the brake pedal.

### Manual transmission models

Depress the clutch pedal, and shift to one of the forward gears when facing uphill, or **[R]** when facing downhill, then release the brake pedal.

\* Not available on all models

### ▶▶ Starting to Drive

#### Manual transmission models with rear fog light

If the engine stalls, fully depress the clutch pedal within three seconds. The engine may automatically restart under certain conditions. Otherwise, follow the standard procedure.

You can also release the parking brake by pressing the electric parking brake switch while depressing the brake pedal. When facing downhill, you can start your vehicle more smoothly by manually releasing it with the electric parking brake switch than by releasing it with the accelerator pedal.

#### ▶▶ Hill start assist system

Hill start assist may not prevent the vehicle from rolling downhill on a very steep or slippery slope, and will not operate on small inclines.

Hill start assist will operate even when VSA is switched off.

Hill start assist is not a replacement for the parking brake.

Models with keyless access system

## Starting the Engine

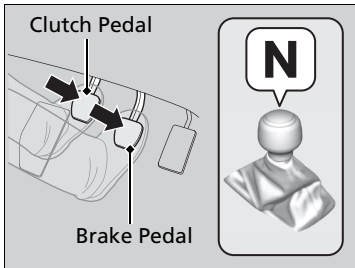
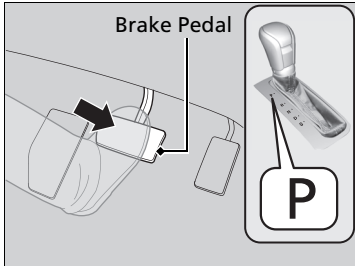

1. Make sure the parking brake is applied.
  - ▶ The parking brake and brake system indicator (red) comes on for 15 seconds when you pull up the electric parking brake switch.

Continuously variable transmission models

2. Check that the transmission is in **P**, then depress the brake pedal.
  - ▶ Although it is possible to start the vehicle in **N**, it is safer to start it in **P**.

Manual transmission models

2. Check that the shift lever is in **N**. Then depress the brake pedal with your right foot, and the clutch pedal with your left foot.
  - ▶ The clutch pedal must be fully depressed to start the engine.

### Starting the Engine

Keep your foot firmly on the brake pedal when starting the engine.

The engine is harder to start in cold weather and in thinner air found at altitudes above 2,400 metres (8,000 feet).

When starting the engine in cold weather, turn off all electrical accessories such as the lights, climate control system, and rear demister in order to reduce battery drain.

If exhaust system sounds abnormal or you can smell exhaust gas inside the vehicle, have your vehicle checked by a dealer. There may be a problem with the engine or exhaust system.

Bring the keyless remote close to the **ENGINE START/STOP** button if the battery in the keyless remote is weak.

▶ **If the Keyless Remote Battery is Weak**  
P. 770

The engine may not start if the keyless remote is subjected to strong radio waves.

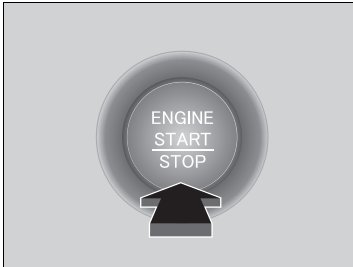

**All models**

3. Press the **ENGINE START/STOP** button without depressing the accelerator pedal.

## ■ Stopping the Engine

You can turn the engine off when the vehicle is completely stopped.

**Continuously variable transmission models**

1. Put the transmission into **P**.
2. Press the **ENGINE START/STOP** button.

**Manual transmission models**

- If the shift lever is in **N**, press the **ENGINE START/STOP** button.
- If the shift lever is in any gear other than **N**, depress the clutch pedal, then press the **ENGINE START/STOP** button.

**Starting the Engine**

Do not hold the **ENGINE START/STOP** button to start the engine.

If the engine does not start, wait at least 30 seconds before starting the engine again.

The immobilizer system protects your vehicle from theft. If an improperly coded device is used, the engine's fuel system is disabled.

➤ **Immobilizer System** P. 207

## Starting to Drive

### Continuously variable transmission models

1. Keeping your right foot on the brake pedal, put the transmission into **[D]**. Select **[R]** when reversing.
2. With the parking brake applied, release the brake pedal and gently depress the accelerator pedal.
  - ▶ Make sure the parking brake and brake system indicator (red) goes off.
    - **Parking Brake** P. 633

### Hill start assist system

Hill start assist keeps the brake engaged briefly to help to prevent the vehicle from rolling on inclines as you move your foot from the brake pedal to the accelerator.

### Continuously variable transmission models

Put the transmission into **[D]** or **[S]** when facing uphill, or **[R]** when facing downhill, then release the brake pedal.

### Manual transmission models

Depress the clutch pedal, and shift to one of the forward gears when facing uphill, or **[R]** when facing downhill, then release the brake pedal.

## Starting to Drive

### Manual transmission models

If the engine stalls, fully depress the clutch pedal within three seconds. The engine may automatically restart under certain conditions. Otherwise, follow the standard procedure.

You can also release the parking brake by pressing the electric parking brake switch while depressing the brake pedal. When facing downhill, you can start your vehicle more smoothly by manually releasing it with the electric parking brake switch than by releasing it with the accelerator pedal.

### Hill start assist system

Hill start assist may not prevent the vehicle from rolling downhill on a very steep or slippery slope, and will not operate on small inclines.

Hill start assist will operate even when VSA is switched off.

Hill start assist is not a replacement for the parking brake.

## Precautions While Driving

### ■ In a Fog

Visibility becomes low when it is foggy. When you drive, turn on the low beam headlights even during the daytime. Slow down, using the road line in the centre, guard rails, and the taillights of the vehicle ahead of you as your driving guide.

### ▶▶ Precautions While Driving

**CAUTION:** Do not drive on the road where water is deep. Driving through deep water will cause damage to the engine and electrical equipment and the vehicle will break down.

#### Continuously variable transmission models

#### NOTICE

Do not operate the shift lever while pressing the accelerator pedal. You could damage the transmission.

#### NOTICE

If you repeatedly turn the steering wheel at an extremely low speed, or hold the steering wheel in the full left or right position for a while, the electric power steering (EPS) system heats up. The system goes into a protective mode, and limits its performance. The steering wheel becomes harder and harder to operate. Once the system cools down, the EPS system is restored.

Repeated operation under these conditions can eventually damage the system.

*Continued*

## ■ In a Strong Wind

If a strong side wind drifts your vehicle while driving, hold the steering wheel tight. Slowly decelerate your vehicle and keep your vehicle in the middle of the road. Be careful with wind gusts especially when your vehicle is exiting a tunnel, driving on a bridge or river bank, and driving through an open area like a quarry, and when a large lorry is passing by.

## ▣ Precautions While Driving

If the ignition switch is turned to ACCESSORY [I]\*<sup>1</sup> while driving, the engine will shut down and all steering and brake power assist functions will stop, making it difficult to control the vehicle.

Do not put the shift lever in [N], as you will lose engine braking (and acceleration) performance.

During the first 1,000 km (625 miles) of operation, avoid sudden acceleration or full throttle operation so as not to damage the engine or powertrain.

Avoid hard braking for the first 300 km (200 miles). You should also follow this when the brake pads are replaced.

### NOTICE

#### 2.0 L engine models

The following can damage the under spoiler:

- Parking the vehicle by a parking block
- Parallel parking along the road shoulder
- Driving towards the bottom of a hill
- Driving up or down to a different surface level (such as a road shoulder)
- Driving on a rutted or bumpy road
- Driving on a road with potholes

\*1: Models with the keyless access system have an **ENGINE START/STOP** button instead of an ignition switch.

### ■ In Rain

The road is slippery when raining. Avoid hard braking, rapid acceleration, and abrupt steering and be more cautious when driving. It is likely to experience hydroplaning phenomenon if you are driving on a rutted road with puddles. Do not drive in deep water and on flooded roads. This can damage the engine or driveline, or cause electrical component failure.

### ■ Other Precautions

If there is a strong impact with something under the vehicle, stop in a safe location. Check the underside of the vehicle for damage or any fluid leaks.

## Continuously Variable Transmission \*

### ■ Creeping

The engine runs at a higher idle speed and creeping increases. Keep the brake pedal firmly depressed when stopped.

### ■ Kickdown

Quickly depressing the accelerator pedal while driving uphill may cause the transmission to drop to a lower ratio, unexpectedly increasing vehicle speed. Depress the accelerator pedal carefully, especially on slippery roads and curves.

\* Not available on all models

### ▣ In Rain

Be careful when hydroplaning phenomenon occurs. When you drive on a road covered with water at excessive speed, a layer of water builds between the tyres and the road surface. If this occurs, the vehicle cannot respond to control inputs such as steering, and braking.

Slowly decelerate when you shift down. If the road is slippery, sudden engine braking can cause the tyres to skid.

Continuously variable transmission models with 6 positions

## Shifting

Change the shift position in accordance with your driving needs.

### ■ Shift lever positions

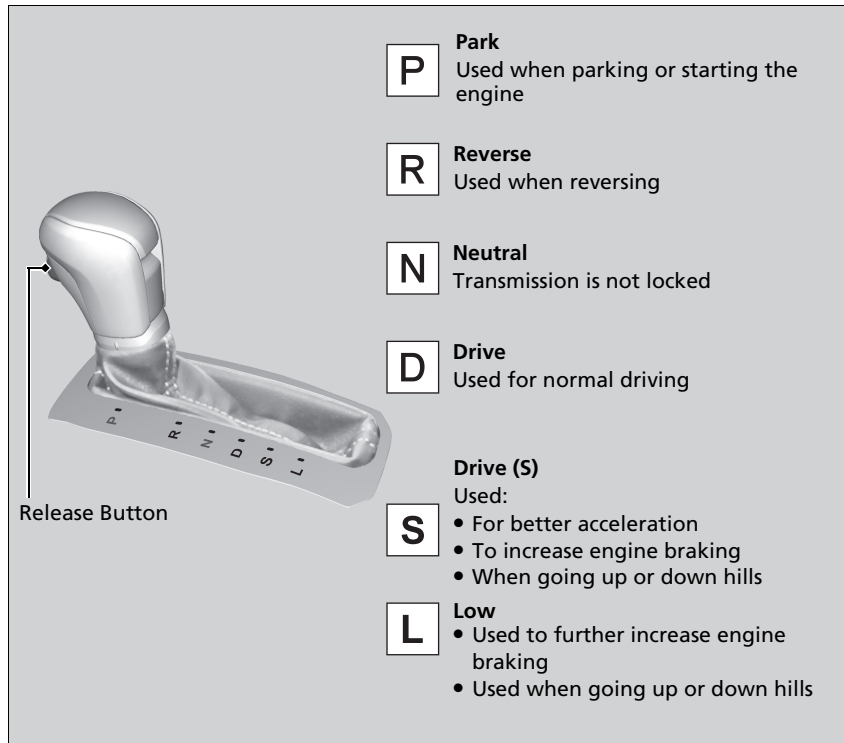

### ✕ Shift lever positions

You cannot turn the ignition switch to LOCK [O] and remove the key unless the shift lever is in [P].

The vehicle may move very slightly even in [N] while the engine is cold.

Depress the brake pedal firmly and, when necessary, apply the parking brake.

## ■ Shift Lever Operation

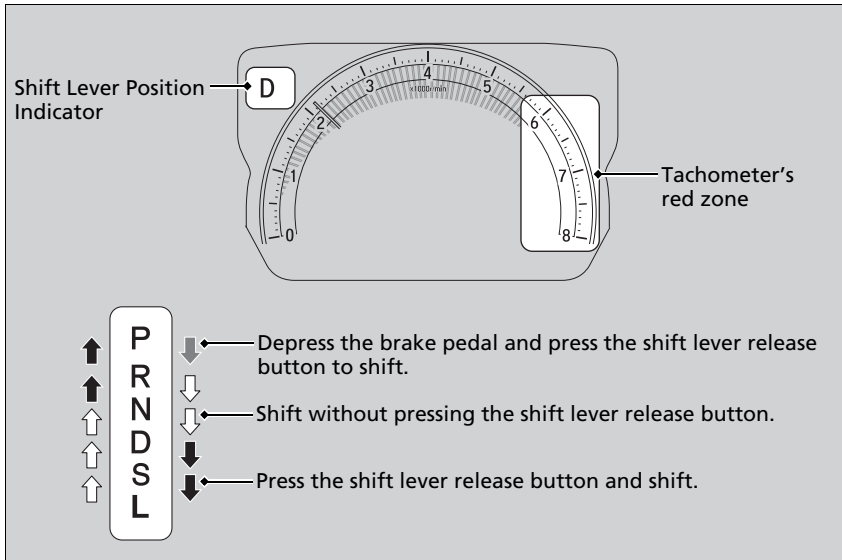

## ▣ Shift Lever Operation

### NOTICE

When you change the shift lever from **D** to **R** and vice versa, come to a complete stop and keep the brake pedal depressed.

Operating the shift lever before the vehicle has come to a complete standstill can damage the transmission.

Use the shift lever position indicator to check the lever position before pulling away.

Whichever position the shift lever is in when driving, blinking transmission system indicator indicates a transmission problem.

Avoid sudden acceleration and have the transmission checked by a dealer as soon as possible.

The fuel supply may be cut off if you drive at engine speeds in or over the tachometer's red zone (engine speed limit). If this happens, you may experience a slight jolt.

It may not be possible to operate the shift lever if the brake pedal is applied while the shift lever release button is held down.

Depress the brake pedal first.

Continuously variable transmission models with 5 positions

## Shifting

Change the shift position in accordance with your driving needs.

### ■ Shift lever positions

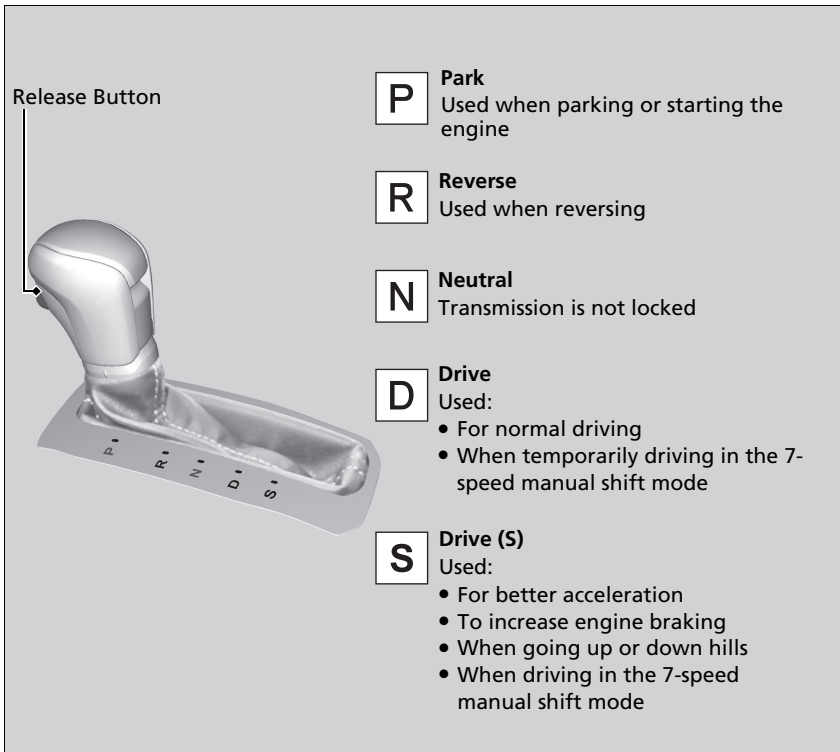

### ▣ Shift lever positions

You cannot turn the ignition switch to LOCK **[0]**\*1 and remove the key unless the shift lever is in **[P]**.

The vehicle may move very slightly even in **[N]** while the engine is cold.

Depress the brake pedal firmly and, when necessary, apply the parking brake.

\*1: Models with the keyless access system have an **ENGINE START/STOP** button instead of an ignition switch.



## Shift Lever Operation

### 1.0 L engine models

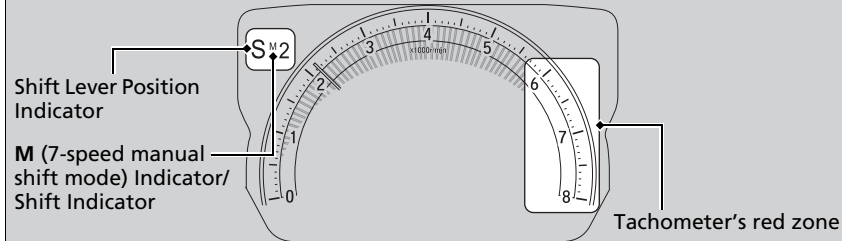

### 1.5 L engine models

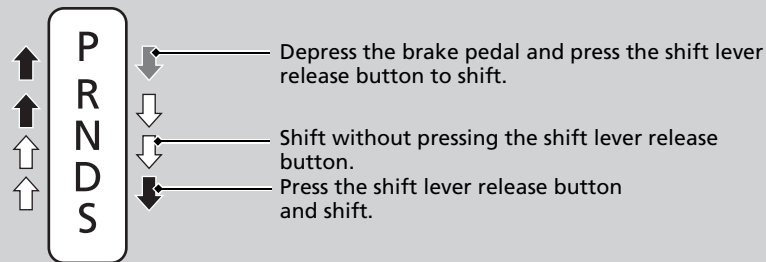
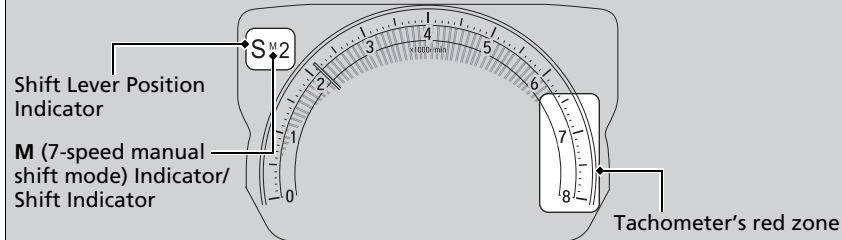

## Shift Lever Operation

### NOTICE

When you change the shift lever from **D** to **R** and vice versa, come to a complete stop and keep the brake pedal depressed.

Operating the shift lever before the vehicle has come to a complete standstill can damage the transmission.

Use the shift lever position indicator to check the lever position before pulling away.

Whichever position the shift lever is in when driving, blinking transmission system indicator indicates a transmission problem.

Avoid sudden acceleration and have the transmission checked by a dealer as soon as possible.

The fuel supply may be cut off if you drive at engine speeds in or over the tachometer's red zone (engine speed limit). If this happens, you may experience a slight jolt.

It may not be possible to operate the shift lever if the brake pedal is applied while the shift lever release button is held down. Depress the brake pedal first.

Continued

## ■ 7-Speed Manual Shift Mode

Use the paddle shifters to change between 1st and 7th speeds without releasing your hands from the steering wheel. The transmission switches to the 7-speed manual shift mode when you pull a paddle shifter while driving. This mode is useful when engine braking is needed.

### ■ When the shift lever is in **[D]**:

The shift mode goes into the 7-speed manual shift mode temporarily, and the number is displayed in the shift indicator.

The 7-speed manual shift mode is cancelled automatically if you drive at constant speed or accelerate, and the number in the shift indicator goes off.

You can cancel this mode by pulling the **[+]** paddle shifter for a few seconds.

The 7-speed manual shift mode is especially useful when reducing the vehicle speed temporarily before making a turn.

### ■ When the shift lever is in **[S]**:

The shift mode goes into the 7-speed manual shift mode. The **M** indicator and the speed number are displayed in the shift indicator. As the vehicle speed slows down, the transmission automatically shifts down accordingly. When the vehicle comes to a stop, it automatically shifts down into 1st.

If the vehicle speed increases and the engine speed reaches near the tachometer's red zone, the transmission automatically shifts up.

## ☒ 7-Speed Manual Shift Mode

In the 7-speed manual shift mode, the transmission shifts up or down by operating either paddle shifter under the following conditions:

Shift Up: The engine speed reaches the lowest threshold of the higher speed position.

Shift Down: The engine speed reaches the highest threshold of the lower speed position.

When the engine speed reaches near the tachometer's red zone, the transmission shifts up automatically.

When the engine speed reaches the lowest threshold of the selected speed position, the transmission shifts down automatically.

Operating the paddle shifters on slippery surfaces may cause the tyres to lock up. In this case, the 7-speed manual shift mode is cancelled and goes back to the normal **[D]** driving mode.

## ■ 7-Speed Manual Shift Mode Operation

When cancelling the 7-speed manual shift mode, move the shift lever from **S** to **D**. When the 7-speed manual shift mode is cancelled, the **M** indicator and shift indicator will turn off.

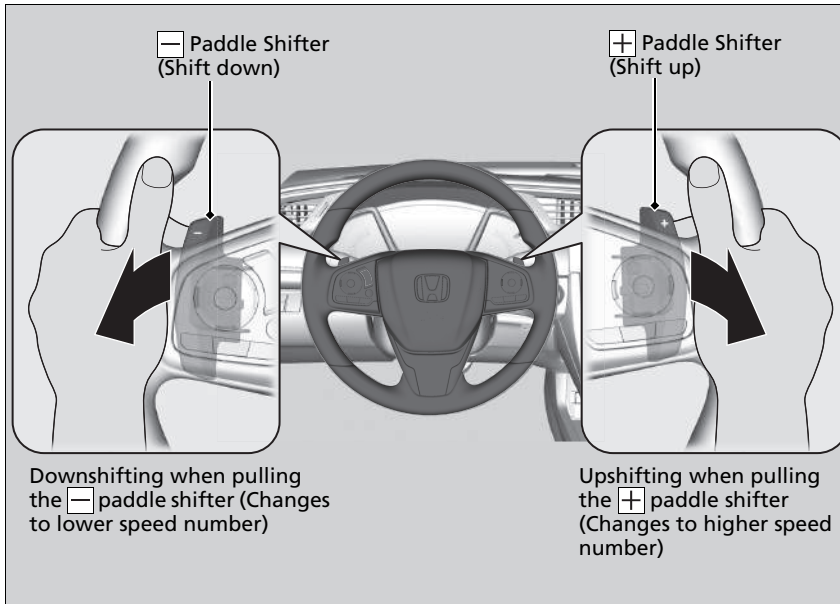

## ▣ 7-Speed Manual Shift Mode Operation

Each paddle shift operation makes a single speed change.

To change continuously, release the paddle shifter before pulling it again for the next speed.

The shift indicator blinks when you cannot shift up or down. It indicates that your vehicle speed is not in its allowable shifting range.

Slightly accelerate to shift up and decelerate to shift down while the indicator is blinking.

## ■ Shift Up/Down\* Indicators

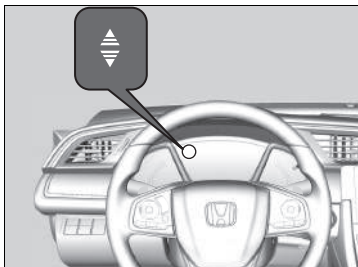

Comes on while the vehicle is in the 7-speed manual shift mode to indicate when shifting is appropriate to maintain the most fuel efficient driving style.

The shift up indicator: Comes on when upshifting is recommended.

### 1.5 L engine models

The shift down indicator: Comes on when downshifting is recommended.

## ☒ Shift Up/Down\* Indicators

### ⚠ WARNING

The shift indicator is only a guide to help you achieve better fuel economy. **Never refer to the Shift Indicators when road and traffic conditions are unsuitable or when it may distract you.**

### 1.5 L engine models

This indicator will not prompt you to downshift to increase engine braking. It is up to you to downshift to increase engine braking when driving downhill.

Always shift down at the appropriate vehicle speed.

Ambient meter colour may change if you do not change gears when a shift indicator illuminates. This can result in a change in fuel economy.

Road and traffic conditions may require you to shift at times other than those indicated.

## Manual transmission models

## Shifting

### ■ Shift Lever Operation

Fully depress the clutch pedal to operate the shift lever and change gears, then slowly release the pedal.

Depress the clutch pedal, and pause for a few seconds before shifting into **R**, or shift into one of the forward gears for a moment. This stops the gears so they do not "grind."

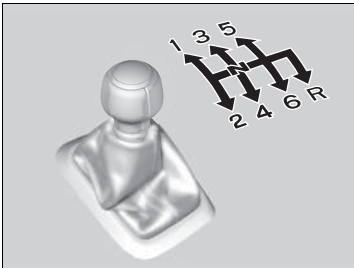

When you are not shifting, do not rest your foot on the clutch pedal. This can cause your clutch to wear out faster.

### » Shift Lever Operation

**NOTICE**

Do not shift to **R** before the vehicle comes to a complete stop.

Shifting to **R** before stopping can damage the transmission.

**NOTICE**

Before downshifting, make sure the engine will not go into the tachometer's red zone. Should this occur, it can severely damage your engine.

**2.0 L engine models**

There is a metallic part on the shift lever. If you leave the vehicle parked outside for a long time on a hot day, be careful before moving the shift lever. Because of heat, the shift lever may be extremely hot. If the outside temperature is low, the shift lever may feel cold.

If you exceed the maximum speed for the gear you are in, the engine speed will enter into the tachometer's red zone. When this happens, you may experience a slight jolt.

Models with rear fog light

## Shift Up/Down Indicators

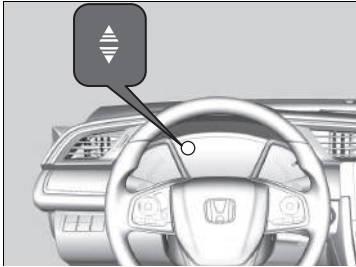

### Models with Honda Sensing

Come on to notify you that a gear change is recommended in order to maintain fuel-efficient driving or to prevent the engine from stalling.

### Models without Honda Sensing

Come on to notify you that a gear change is recommended in order to maintain fuel-efficient driving.

### All models

The shift up indicator: Comes on when upshifting is recommended.

The shift down indicator: Comes on when downshifting is recommended.

### Shift Up/Down Indicators

## ⚠ WARNING

The shift indicator is a guide to help you achieve better fuel economy. Never refer to the Shift Indicators when road and traffic conditions are unsuitable or when it may distract you.

This indicator will not prompt you to downshift to increase engine braking. It is up to you to downshift to increase engine braking when driving downhill.

Always shift down at the appropriate vehicle speed.

The shift down indicator does not come on when downshifting from [2] to [1].

### 1.0 L and 1.5 L engine models

Ambient meter colour may change if you do not change gears when a shift indicator illuminates. This can result in a change in fuel economy.

Road and traffic conditions may require you to shift at times other than those indicated.

## 2.0 L engine models

**■ Rev Match System**

Adjusts the engine's RPM to match the optimal speed of the gear that is about to be engaged.

➤ **Drive Mode Switch** P. 526

**■ Limitations**

The rev match system will not activate under the following conditions:

- You are shifting into a lower gear, but the system has determined that the engine will over rev.
- You are shifting into 1st gear from a higher gear.
- Engine RPM is low and you are shifting into a lower gear in sequential order.
- The system has determined that the engine will be at idling speed after you have shifted into a higher gear.
- The clutch pedal is not fully depressed.

The rev match system may deactivate if the clutch is kept engaged for an extended period of time.

## ➤ Rev Match System

You can turn off the rev match system using the driver information interface or the audio/information screen\*.

➤ **Customized Features\*** P. 171, 396

If you depress the accelerator pedal while changing gears, the system will give priority to inputs from the accelerator pedal.

If the message below appears, there may be a problem with the system. The rev match system may not operate, but you can perform regular gear shifting. Have the system checked by a dealer.

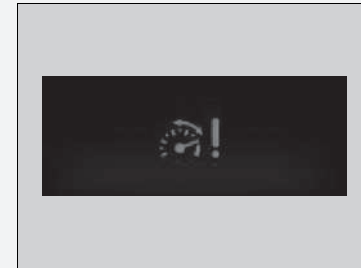

\* Not available on all models

## Reverse Lockout

The manual transmission has a lockout mechanism that stops you from accidentally shifting into **R** from a forward gear while the vehicle is moving above a certain speed.

If you cannot shift to **R** when the vehicle is stopped, do the following:

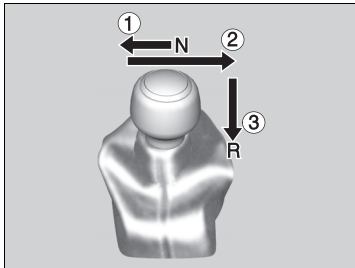

1. Depress the clutch pedal, move the shift lever all the way to the left, and shift to **R**.
2. If you still cannot shift into **R**, apply the parking brake, and turn the ignition switch to ACCESSORY **I** or LOCK **O**\*1.
3. Depress the clutch pedal and shift into **R**.
4. Keep depressing the clutch pedal and start the engine.

Have the vehicle checked by a dealer if you have to go through this procedure repeatedly.

\* 1: Models with the keyless access system have an **ENGINE START/STOP** button instead of an ignition switch.



## ECON Mode\*

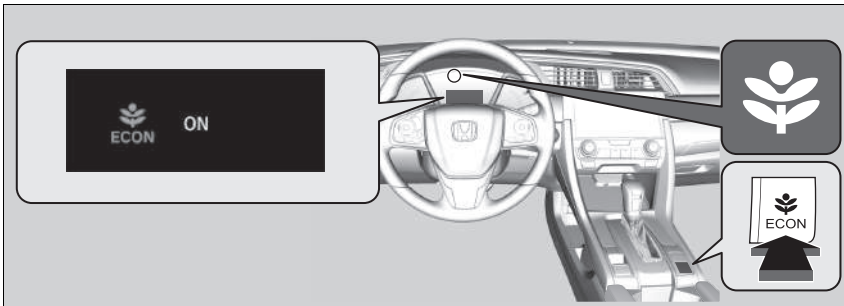

The **ECON** button turns the ECON mode on and off. The ECON mode helps you improve your fuel economy by adjusting the performance of the climate control system and cruise control\*.

### ▣ ECON Mode\*

While in ECON mode, the climate control system has greater temperature fluctuations.

\* Not available on all models

1.0 L engine models with continuously variable transmission

## Auto Idle Stop

To help to maximise fuel economy, the engine automatically stops when the vehicle comes to a stop, depending on environmental and vehicle operating conditions. The indicator (green) comes on at this time.

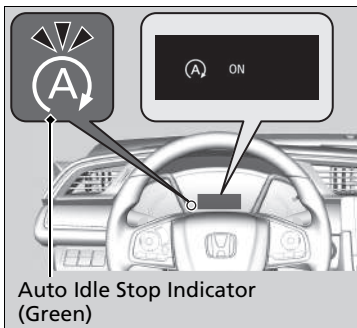

The engine then restarts once the vehicle is about to move again, and the indicator (green) goes off.

➤ **The Engine Automatically Restarts When:**  
P. 518

The environmental and vehicle conditions that impact Auto Idle Stop system operation are varied.

➤ **Auto Idle Stop Activates When:**  
P. 516, 517

If the driver's door is opened while the indicator (green) is on, a buzzer sounds to notify you that the Auto Idle Stop function is in operation.

A message associated with Auto Idle Stop appears on the driver information interface.

➤ **Indicators** P. 108  
➤ **Customized Features\*** P. 171, 396

### Auto Idle Stop

The 12-volt battery installed in this vehicle is specifically designed for a model with Auto Idle Stop. Using a 12-volt battery other than this specified type may shorten the 12-volt battery life, and prevent Auto Idle Stop from activating. If you need to replace the 12-volt battery, make sure to select the specified type. Ask a dealer for more details.

➤ **Specifications** P. 804

The duration of the Auto Idle Stop operation:

- **Increase** in the ECON mode, compared to when the ECON mode is off, with climate control\* in use.

## ■ Auto Idle Stop System ON/OFF

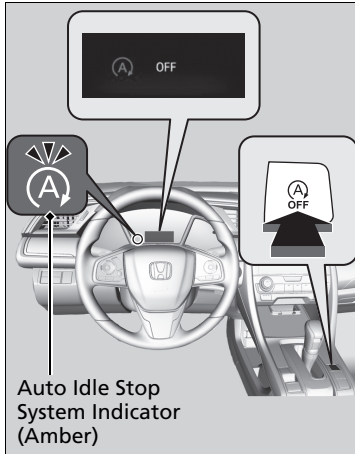

To turn the Auto Idle Stop system off, press this button. The Auto Idle Stop system stops.

- ▶ Auto Idle Stop system will stop and the indicator (amber) will come on.

The Auto Idle Stop system is turned on every time you start the engine, even if you turned it off the last time you drove the vehicle.

## ▶▶ Auto Idle Stop System ON/OFF

Pressing the Auto Idle Stop **OFF** button restarts the engine during the Auto Idle Stop activated.

*Continued*

## ■ Auto Idle Stop Activates When:

The vehicle stops with the shift lever in **D** and the brake pedal depressed.

### ■ Auto Idle Stop does not activate when:

- The Auto Idle Stop **OFF** button is pressed.
- The driver's seat belt is not fastened.
- The engine coolant temperature is low or high.
- The transmission fluid temperature is low or high.
- The vehicle comes to a stop again before the vehicle speed reaches 5 km/h (3 mph) after the engine starts.
- Stopped on a steep incline.
- The engine is started with the bonnet open.
  - ▶ Turn off the engine. Close the bonnet before you restart the engine to activate Auto Idle Stop.
- The battery charge is low.
- The internal temperature of the battery is 5°C or less.
- The transmission is in a position other than **D**.
- The heating system\*/climate control system\* is in use, and the outside temperature is below -20°C or over 40°C.
- The heating system\*/climate control system\* is in use, and the temperature is set to **Hi** or **Lo**.
-  is ON (indicator on).

## ☒ Auto Idle Stop Activates When:

Do not open a bonnet, while the Auto idle Stop function is activated.

If the bonnet is opened, the engine will not restart automatically.

In this case, restart the engine with the ignition switch\* or the **ENGINE START/STOP** button\*.

☒ **Starting the Engine** P. 493, 496

### Models with keyless access system

Pressing the **ENGINE START/STOP** button changes the power mode to ACCESSORY even while Auto Idle Stop is in operation. Once in ACCESSORY, the engine no longer restarts automatically. Follow the standard procedure to start the engine.

☒ **Starting the Engine** P. 496

### Models without keyless access system

Even if you turn the ignition switch to START **III** during the Auto Idle Stop activated, the engine does not start.

### Models with ACC with Low Speed Follow

When ACC with Low Speed Follow is in operation, the vehicle stops without depressing the brake pedal and Auto Idle Stop may activate.

In such case, the engine may restart if you move the shift lever other than **D**.

■ **Auto Idle Stop may not activate when:**

- The vehicle is stopped by braking suddenly.
- The steering wheel is operated.
- Altitude is high.
- The vehicle is repeatedly accelerated and decelerated at a low speed.
- The fan speed is high.
- The heating system\*/climate control system\* is in use, and there is a significant difference between the set temperature and the actual interior temperature.
- The heating system\*/climate control system\* is in use, and humidity in the interior is high.

\* Not available on all models

### ■ The Engine Automatically Restarts When:

- The brake pedal is released (without the automatic brake hold system activated).
- The accelerator pedal is depressed (with the automatic brake hold system activated).

➤ **Automatic Brake Hold** P. 636

### ■ The engine restarts even if the brake pedal is depressed\*<sup>1</sup> when:

- The Auto Idle Stop **OFF** button is pressed.
- A steering wheel is operated.
- The transmission is put into **[R]**, **[S]** or **[L]**<sup>\*</sup>, or when it is set from **[N]** to **[D]**.
- The pressure on the brake pedal is reduced and the vehicle starts moving while stopped on an incline.
- The pressure on the brake pedal is repeatedly applied and released slightly during a stop.
- The battery charge becomes low.
- The accelerator pedal is depressed.
- The driver's seat belt is unlatched.
-  is ON (indicator on).
- The heating system\*/climate control system\* is in use, and the difference between the set temperature and actual interior temperature becomes significant.
- The heating system\*/climate control system\* is being used to dehumidify the interior.

#### Models with ACC with Low Speed Follow

- The vehicle ahead of you starts again when your vehicle stops automatically with ACC with Low Speed Follow.

### ☒ The Engine Automatically Restarts When:

If you are using an electronic device during Auto Idle Stop, the device may temporarily be turned off when the engine restarts.

### ☒ The engine restarts even if the brake pedal is depressed\*<sup>1</sup> when:

\* 1: With the automatic brake hold system activated, you can release the brake pedal during Auto Idle Stop is in operation.

If the automatic brake hold system has been turned off, or if there is a problem with the system, the engine will restart automatically when you release the brake pedal.

➤ **Automatic Brake Hold** P. 636

### ■ Starting Assist Brake Function

Briefly keeps the brake applied after releasing the brake pedal to restart the engine. This can keep your vehicle from unexpectedly moving while on an incline.

Manual transmission models with rear fog light

## Auto Idle Stop

To help to maximise fuel economy, the engine automatically stops when the vehicle comes to a stop, depending on environmental and vehicle operating conditions. The indicator (green) comes on at this time.

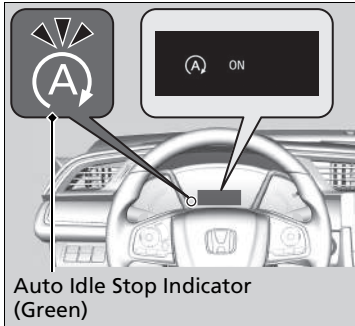

The engine then restarts once the vehicle is about to move again, or depending on environmental and vehicle conditions, and the indicator (green) goes off.

➤ **The Engine Automatically Restarts When:**  
P. 524

The environmental and vehicle conditions that impact Auto Idle Stop system operation are varied.

➤ **Auto Idle Stop Activates When:**  
P. 522, 523

If the driver's door is opened while the indicator (green) is on, a buzzer sounds to notify you that the Auto Idle Stop function is in operation.

A message associated with Auto Idle Stop appears on the driver information interface.

➤ **Indicators** P. 108  
➤ **Customized Features\*** P. 171, 396

### Auto Idle Stop

The 12-volt battery installed in this vehicle is specifically designed for a model with Auto Idle Stop. Using a 12-volt battery other than this specified type may shorten the 12-volt battery life, and prevent Auto Idle Stop from activating. If you need to replace the 12-volt battery, make sure to select the specified type. Ask a dealer for more details.

➤ **Specifications** P. 804

### Models with ECON button

The duration of Auto Idle Stop operation:

- **Increases** in the ECON mode, compared to when the ECON mode is off, with climate control\* in use.



## ■ Auto Idle Stop System ON/OFF

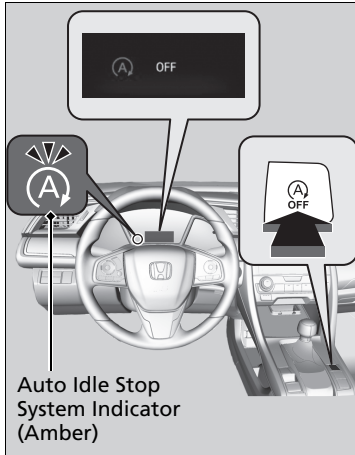

To turn the Auto Idle Stop system off, press this button. The Auto Idle Stop system stops.

- ▶ Auto Idle Stop system will stop and the indicator (amber) will come on.

The Auto Idle Stop system is turned on every time you start the engine, even if you turned it off the last time you drove the vehicle.

## ▣ Auto Idle Stop System ON/OFF

Pressing the Auto Idle Stop **OFF** button restarts the engine during the Auto Idle Stop activated.

*Continued*

## ■ Auto Idle Stop Activates When:

After the vehicle moves forward, stopping with the brake, the clutch pedal fully depressed, the shift lever in **[N]**, and then the clutch pedal is released.

▶ To restart the engine automatically, depress the clutch pedal.

## ■ Auto Idle Stop does not activate when:

- The Auto Idle Stop **OFF** button is pressed.
- The driver's seat belt is not fastened.
- The engine coolant temperature is low or high.
- The vehicle comes to a stop again before the vehicle speed reaches 3 km/h (2 mph) after the engine starts.
- The engine is started with the bonnet open.
  - ▶ Turn off the engine. Close the bonnet before you restart the engine to activate Auto Idle Stop.
- The battery charge is low.
- The internal temperature of the battery is 5°C or less.
- The shift lever is in any position except **[N]**.
- The heating system\*/climate control system\* is in use, and the outside temperature is below -20°C or over 40°C.
- The heating system\*/climate control system\* is in use, and the temperature is set to **Hi** or **Lo**.
-  is on (indicator on).

### 2.0 L engine models

- The drive mode is changed to **+R** mode.

## ☒ Auto Idle Stop Activates When:

Do not open a bonnet, while the Auto idle Stop function is activated.

If the bonnet is opened, the engine will not restart automatically.

In this case, restart the engine with the ignition switch\* or the **ENGINE START/STOP** button\*.

☒ **Starting the Engine** P. 493, 496

### Models with keyless access system

Pressing the **ENGINE START/STOP** button changes the power mode to ACCESSORY even while Auto Idle Stop is in operation. Once in ACCESSORY, the engine no longer restarts automatically. Follow the standard procedure to start the engine.

☒ **Starting the Engine** P. 496

### Models without keyless access system

Even if you turn the ignition switch to START **[III]** during the Auto Idle Stop activated, the engine does not start.

■ **Auto Idle Stop may not activate when:**

- The steering wheel is operated.
- Altitude is high.
- The fan speed is high.
- The heating system\*/climate control system\* is in use, and there is a significant difference between the set temperature and the actual interior temperature.
- The heating system\*/climate control system\* is in use, and humidity in the interior is high.

\* Not available on all models

## ■ The Engine Automatically Restarts When:

The clutch pedal is depressed.

### ■ The engine automatically restarts even if the clutch pedal is not depressed with the transmission in **N** when:

- The Auto Idle Stop **OFF** button is pressed.
- A steering wheel is operated.
- The pressure on the brake pedal is repeatedly applied and released slightly during a stop.
- The battery charge becomes low.

#### 2.0 L engine models

- The drive mode is changed to **+R** mode.

### ☒ The Engine Automatically Restarts When:

If you are using an electronic device during Auto Idle Stop, the device may temporarily be turned off when the engine restarts.

The engine does not restart automatically when there is a problem in the system. Follow the normal procedure to start the engine.

☒ **Starting the Engine** P. 493, 496

The engine does not restart automatically when:

- The driver's seat belt is unlatched. To keep Auto Idle Stop activated, fasten your seat belt immediately.
- The transmission is put into a position other than **N**.

Put the transmission into **N**.

☒ **Driver Information Interface Warning and Information Messages** P. 135

When the system stops operating, follow the normal procedure to start the engine.

☒ **Starting the Engine** P. 493, 496

### ■ When indicator light (Green) blinks in Auto Idle Stop

Fully depress the clutch pedal.

- ▶ The engine automatically restarts.

### ▣ When indicator light (Green) blinks in Auto Idle Stop

The indicator starts blinking rapidly under the following conditions:

-  button is pressed.
- When the climate control system\* is in use and moisture builds up inside the vehicle.
- When the climate control system\* is in use and the difference between the set temperature and the actual temperature inside the vehicle becomes significant.

\* Not available on all models

2.0 L engine models

## Drive Mode Switch

Constantly controls your vehicle's engine, transmission, EPS, dampers, brakes and VSA according to the mode you select.

You can choose between three modes, **+R** mode, **SPORT** mode and **COMFORT** mode by moving the drive mode switch forward or back.

The current mode is displayed on the driver information interface, and each mode will appear differently.

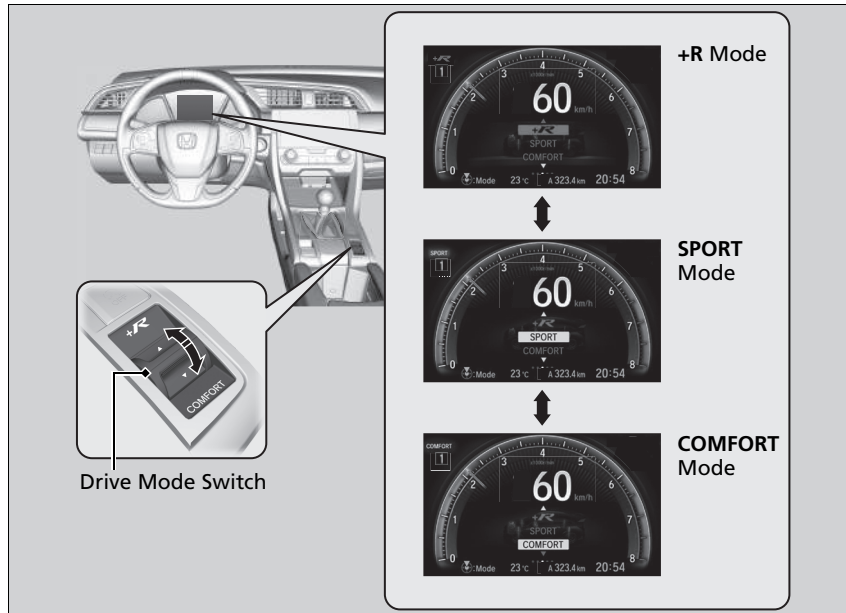

### Drive Mode Switch

**SPORT** mode is selected every time you set the power mode to ON.

The mode may not be able to be changed under some driving conditions. If mode change is necessary, reduce speed or cornering speed.

This message will also appear if you try to change modes when there is a vehicle system failure.

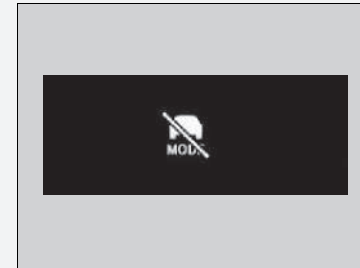

Category		COMFORT	SPORT	+R
Chassis Control	Steering	Light feedback for easy driving.	Increased feedback for sport driving.	Increased feedback for high performance driving.
	Suspension Damping	Minimised to provide a soft ride.	Increased to provide improved handling for sport driving.	Maximised to provide responsive handling for high performance driving.
	VSA and TCS	Balanced calibration for VSA and Traction control in all environments.		Track oriented control allowing increased freedom for the driver.
Powertrain Control	Acceleration Feeling	Relaxed	Aggressive	Aggressive
	Rev Match System	Seamless	Seamless	Responsive

➤ **Vehicle Stability Assist (VSA) System** P. 544

➤ **Rev Match System** P. 511

## Adaptive Damper System \*

Constantly controls your vehicle's dampers according to current road conditions, vehicle speed and steering operation.

You can switch between the dynamic and normal mode, according to your driving taste.

Press the adaptive damper system button and select **ON** (dynamic) or **OFF** (normal) mode. The current mode is displayed on the driver information interface.

📖 **Driver Information Interface Warning and Information Messages** P. 135

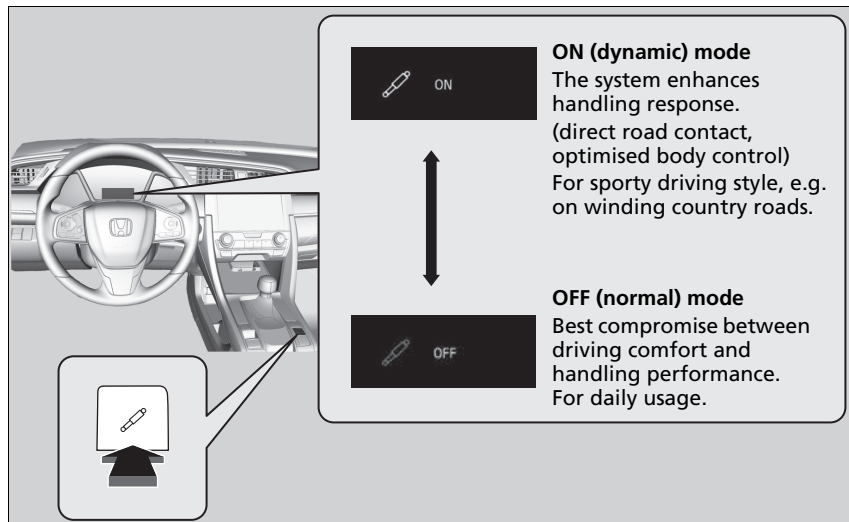

### Adaptive Damper System \*

The adaptive damper system remains in the previous mode next time you set the power mode to ON.



## Cruise Control \*

Maintains a constant vehicle speed without having to keep your foot on the accelerator. Use cruise control on motorways or open roads where you can travel at a constant speed with little acceleration or deceleration.

### When to use

- Vehicle speed for cruise control: Desired speed in a range above roughly 30 km/h (18 mph) to about 200 km/h (124 mph)

### Continuously variable transmission models

- Shift positions for cruise control: In **D** or **S**

Always keep sufficient distance between you and the vehicle in front of you



### How to use

- Press the **MAIN** button on the steering wheel

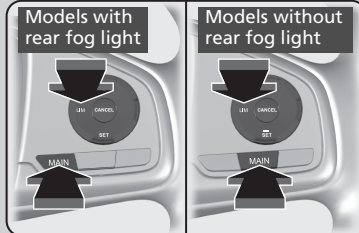

**The indicator is on in the instrument panel**  
Cruise control is ready to use.

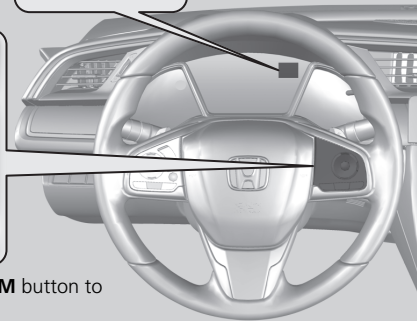

If a different indicator comes on, press the **LIM** button to switch to cruise control.

### »» Cruise Control \*

## ⚠ WARNING

Improper use of the cruise control can lead to a crash.

Use the cruise control only when travelling on open motorways in good weather.

It may not be possible to maintain a constant speed when driving uphill or downhill.

When not using cruise control: Turn off cruise control by pressing the **MAIN** button.

Setting the power mode to ACCESSORY or VEHICLE OFF (LOCK) turns off cruise control automatically.

While in ECON mode\*, it may take relatively more time to accelerate to maintain the set speed.

You cannot use the cruise control and the adjustable speed limiter at the same time.

\* Not available on all models

## ■ To Set the Vehicle Speed

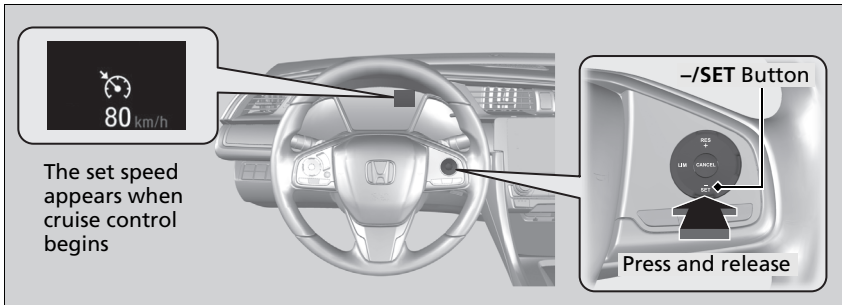

Take your foot off the accelerator pedal and press the **-/SET** button when you reach the desired speed.

The moment you release the **-/SET** button, the set speed is fixed, and cruise control begins. The set speed is displayed.

When you use cruise control, Straight Driving Assist (a feature of the Electric Power Steering system) is activated.

By enabling the steering system to automatically compensate for natural steering pull, Straight Driving Assist makes it easier for you to keep your vehicle in a straight line.

## ☒ To Set the Vehicle Speed

You can switch the displayed set speed measurements on the driver information interface or audio/information screen between km/h and mph.

☒ **Customized Features\*** P. 171, 396

### ■ To Adjust the Vehicle Speed

Increase or decrease the vehicle speed using the **RES/+** or **-/SET** buttons on the steering wheel.

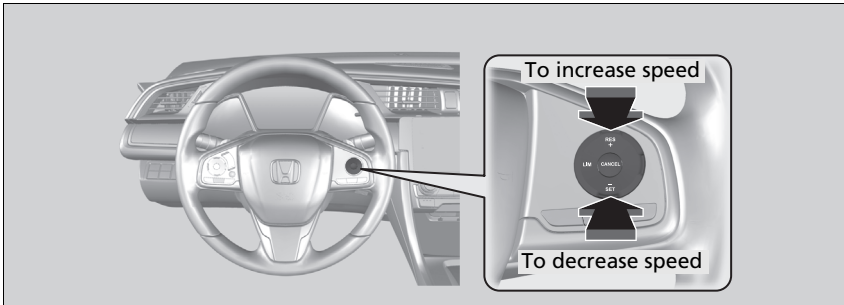

- Each time you press the button, the vehicle speed is increased or decreased by about 1 km/h or 1 mph accordingly.
- If you keep the button pressed, the vehicle speed increases or decreases by about 10 km/h or 10 mph accordingly.

### ▣ To Adjust the Vehicle Speed

You can set the vehicle speed using the **-/SET** button on the steering wheel when adjusting the speed with the accelerator and brake pedals.

## To Cancel

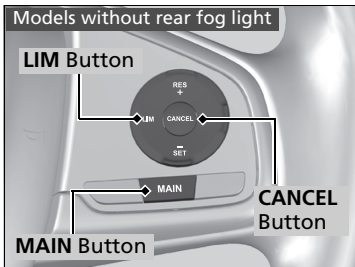
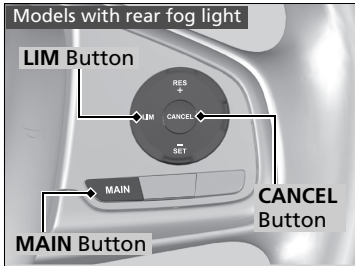

To cancel cruise control, do any of the following:

- Press the **CANCEL** button.
- Press the **MAIN** button.
- Press the **LIM** button.
- Depress the brake pedal.
- Depress the clutch pedal\* for five seconds or more.

The displayed set speed goes off.

## To Cancel

Resuming the prior set speed:

After cruise control has been cancelled, you can still resume the prior set speed by pressing the **RES/+** button while driving at a speed of at least 30 km/h (18 mph) or more.

You cannot set or resume in the following situations:

- When vehicle speed is less than 30 km/h (18 mph)
- When the **MAIN** button is turned off

At vehicle speeds of 25 km/h (16 mph) or less, cruise control is cancelled automatically.

## Adjustable Speed Limiter

This system enables you to set a maximum speed that cannot be exceeded even if you are depressing the accelerator pedal.

### 1.0 L and 1.5 L engine models

The vehicle speed limit can be set from about 30 km/h (18 mph) to about 250 km/h (156 mph).

### 2.0 L engine models

The vehicle speed limit can be set from about 30 km/h (18 mph) to about 320 km/h (199 mph).

### How to use

- Press the **MAIN** button on the steering wheel

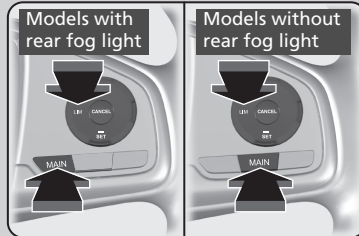

If a different indicator comes on, press the **LIM** button to switch to the adjustable speed limiter.

The indicator is on in the instrument panel  
Adjustable speed limiter is ready to use.



### Adjustable Speed Limiter

## ⚠ WARNING

Adjustable Speed Limiter has limitations. It is always your responsibility to adjust the vehicle speed to obey the actual speed limit, and safely operate the vehicle.

## ⚠ WARNING

Do not depress the accelerator pedal more than necessary. Maintain an appropriate accelerator pedal position depending on the vehicle speed.

The adjustable speed limiter may not hold the set speed limit when driving downhill. If this occurs, slow down by depressing the brake pedal.

When not using the adjustable speed limiter: Turn off the adjustable speed limiter by pressing the **MAIN** button.

You cannot use the adjustable speed limiter and the cruise control\*/Adaptive Cruise Control (ACC)\*/ Adaptive Cruise Control (ACC) with Low Speed Follow\*/Intelligent Speed Limiter\* at the same time.

### Manual transmission models

When the engine speed slows down, try to downshift.

\* Not available on all models

## ■ To Set the Speed Limit

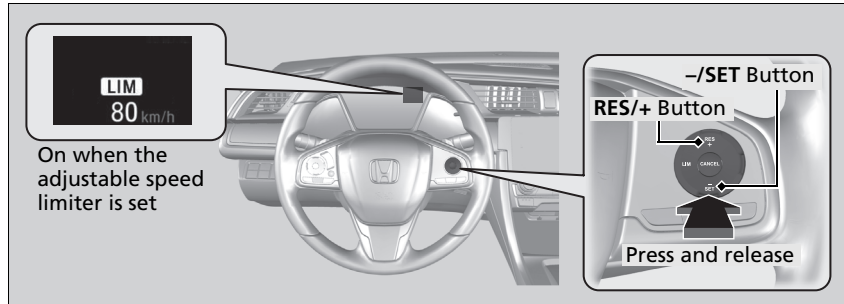

- Take your foot off the pedal and press the **-/SET** button when you reach the desired speed. The moment you release the **-/SET** button, the speed limit is fixed, and the adjustable speed limiter is set. The speed limit is displayed.
- You can set the previously set speed limit by pressing the **RES/+** button.

## ☒ To Set the Speed Limit

If you set the speed limit while travelling at less than 30 km/h (18 mph), the speed limit is set to 30 km/h (18 mph).

The beeper sounds and the displayed speed limit blinks if the vehicle speed exceeds the limit by 3 km/h (2 mph) or more on a steep descent.

The adjustable speed limiter is set to the current speed if it is higher than the previously set speed limit when you press the **RES/+** button.

You can switch the displayed set speed measurements on the driver information interface or audio/information screen between km/h and mph.

☒ **Customized Features\*** P. 171, 396

### ■ To Adjust the Speed Limit

Increase or decrease the speed limit by using the **RES/+** or **-/SET** buttons on the steering wheel.

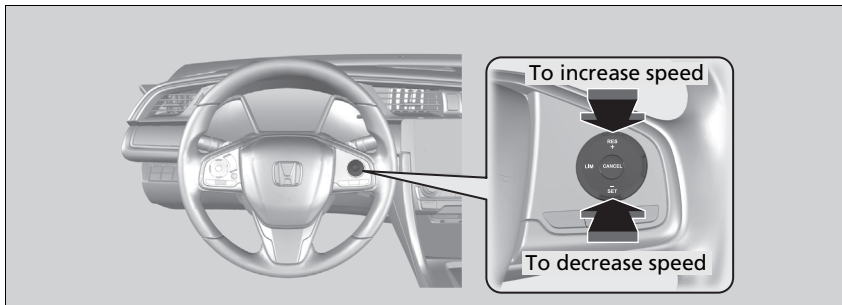

- Each time you press the button, the speed limit increases or decreases by 1 km/h or 1 mph accordingly.
- If you keep the button pressed, the speed limit increases or decreases in increments of 10 km/h or 10 mph every 0.5 second until system limit is reached.
- The vehicle may accelerate or decelerate until the set speed is reached.

### ■ Exceeding the Speed Limit Temporarily

The speed limit can be exceeded by depressing the accelerator pedal completely.

- ▶ The displayed limit speed blinks.
- ▶ The beeper sounds once the speed limit has been exceeded.

#### » Exceeding the Speed Limit Temporarily

The beeper sounds when the vehicle speed goes higher than the set speed limit with the accelerator pedal depressed completely.

The adjustable speed limiter resumes working once the vehicle speed goes lower than the set speed limit.

*Continued*

## To Cancel

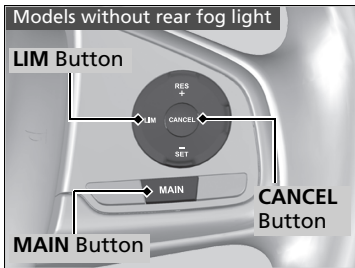
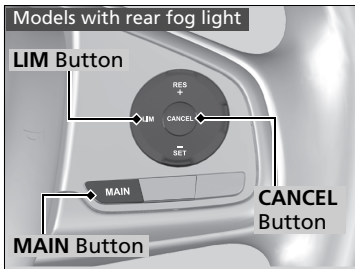

To cancel the adjustable speed limiter, do any of the following:

- Press the **CANCEL** button.
- Press the **MAIN** button.
- Press the **LIM** button.

## To Cancel

The adjustable speed limiter changes into cruise control\*/Adaptive Cruise Control (ACC)/Adaptive Cruise Control (ACC) with Low Speed Follow\*/Intelligent Speed Limiter\* if the **LIM** button is pressed.



If there is a problem with the system when you are using the adjustable speed limiter, the beeper sounds and **OFF** comes on. The adjustable speed limiter will be turned off.



Models with traffic sign recognition system

## Intelligent Speed Limiter

Automatically sets the speed limit that the traffic sign recognition system detects. And the speed limit cannot be exceeded even if you are depressing the accelerator pedal. If you fully depress the accelerator the speed limit can be exceeded.

➤ **Traffic Sign Recognition System** P. 623

### Intelligent Speed Limiter

#### **WARNING**

Intelligent Speed Limiter has limitations. The Intelligent Speed Limiter may set itself to a speed above or below the actual speed limit, or may not work, particularly where the traffic sign recognition system does not operate correctly or where a road has no speed limit signs. It is always your responsibility to adjust the speed to obey the actual speed limit and to safely operate the vehicle.

Depending on the amount of depression of the accelerator pedal, the vehicle will accelerate until it reaches the speed identified by the traffic sign recognition system.

*Continued*

How to use

■ Press the **MAIN** button on the steering wheel

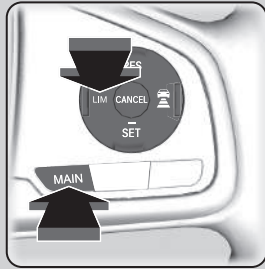

If a different indicator comes on, press the **LIM** button to change it to the intelligent speed limiter.



The indicator is on in the instrument panel  
Intelligent speed limiter is ready to use.

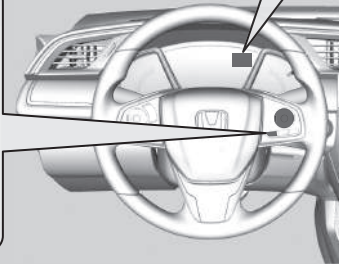

Intelligent Speed Limiter

The system is designed to detect signs that follow the Vienna Convention standards. Not all signs may be detected, but any signs posted on roadsides should not be ignored. The system does not work on the designated traffic signs of all the countries you travel, nor in all situations.

▶ **Traffic Sign Recognition System** P. 623

If the intelligent speed limiter is set to the wrong speed limit, try one of the following:

To cancel

- Press the **CANCEL** button.
- Press the **MAIN** button.
- Press the **LIM** button.

To exceed the speed limit temporarily

- Depressing the accelerator pedal fully.

The intelligent speed limiter may not hold the set speed limit when driving downhill. If this occurs, slow down by depressing the brake pedal.

When not using the intelligent speed limiter, turn off the intelligent speed limiter by pressing the **MAIN** button.

Models with ACC with Low Speed Follow

You cannot use the intelligent speed limiter and ACC with Low Speed Follow or adjustable speed limiter at the same time.

Models with ACC

You cannot use the intelligent speed limiter and ACC or adjustable speed limiter at the same time.

## ■ To Set the Speed Limit

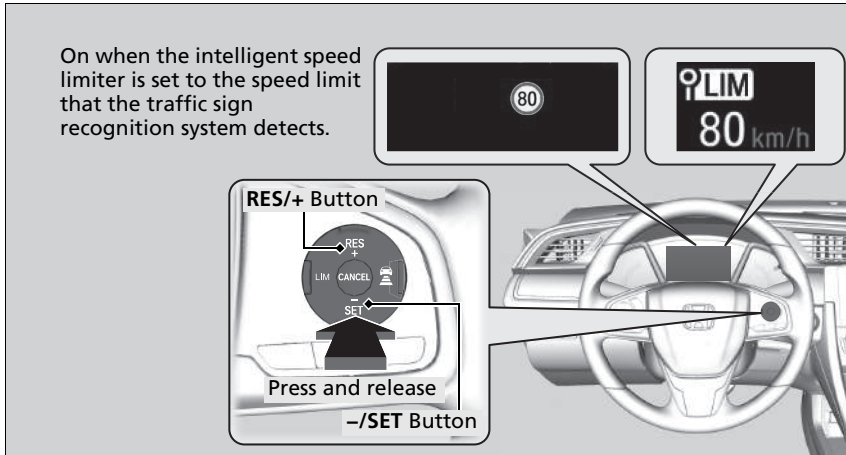

- The moment you release the **-/SET** button or **RES/+** button, the intelligent speed limiter is set to the speed limit that the traffic sign recognition system detects. The speed limit is displayed.

## ▶ Intelligent Speed Limiter

### Manual transmission models

When the engine speed slows down, try to downshift.

Do not use the intelligent speed limiter in areas of different units from the display unit of the intelligent speed limiter.

### Right-hand drive type

Change the displayed measurement of the set vehicle speed to the same units as the driving areas.

➤ **Speedometer** P. 159

## ▶ To Set the Speed Limit

If you set the intelligent speed limiter when the speed limit that the traffic sign recognition system detects is less than 30 km/h (20 mph), the speed limitation function and warning function may switch to pause.

If your vehicle speed is higher than the speed limit that the traffic sign recognition system detects, your vehicle decelerates slowly to the speed limit or less. If necessary, slow down by depressing the brake pedal. And the beeper sounds and the displayed speed limit blinks if the vehicle speed exceeds the limit by 3 km/h (2 mph) or more.

Continued

■ **When the traffic sign recognition system detects the new speed limit sign**

The intelligent speed limiter is set to the new speed limit that the traffic sign recognition system detects.



■ **The speed limitation function and warning function may switch to pause if there is no speed limit sign in the screen of the traffic sign recognition system when:**

- The end of speed limit or other designated limit is detected.
- Your vehicle enters/exits motorway or highway.
- You make a turn with a turn signal to change direction at an intersection.

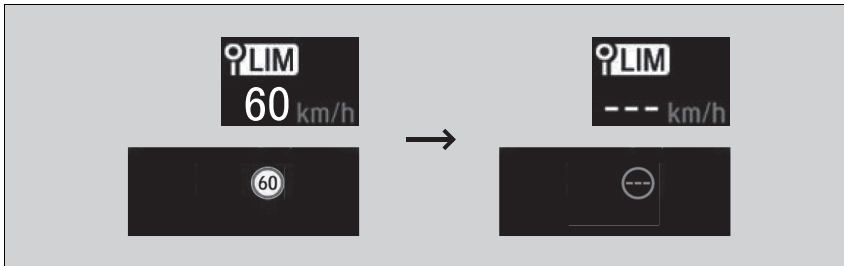

☒ **To Set the Speed Limit**

The intelligent speed limiter may also switch to pause when the traffic sign recognition system detects only additional speed limit signs.

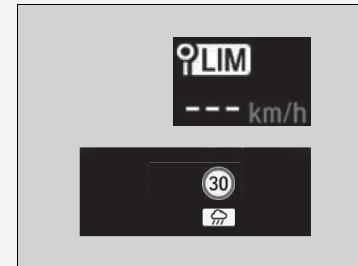

**■ When the traffic sign recognition system detects the speed limit sign while the intelligent speed limiter is paused**

The speed limitation function and warning function will be resumed automatically.

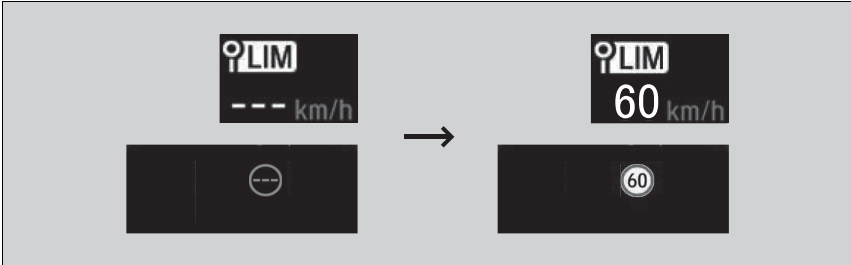

**■ When the traffic sign recognition system does not detect the speed limit sign for a time while the intelligent speed limiter is activated**

While driving, in addition to when the traffic sign recognition system detects no speed limit sign, the traffic sign recognition system may display no speed limit. But, intelligent speed limiter functions continue.

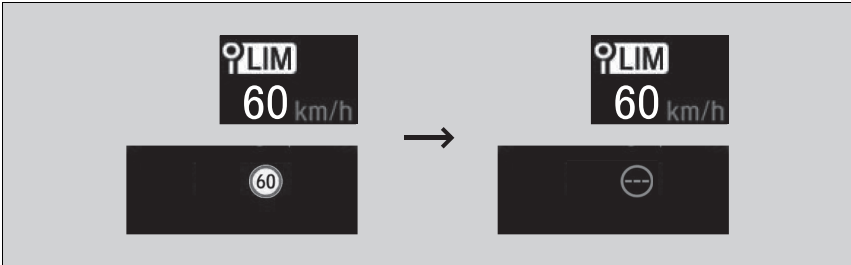

## ■ To Adjust the Speed Limit

Increase or decrease the speed limit by using the **RES/+** or **-/SET** buttons on the steering wheel.

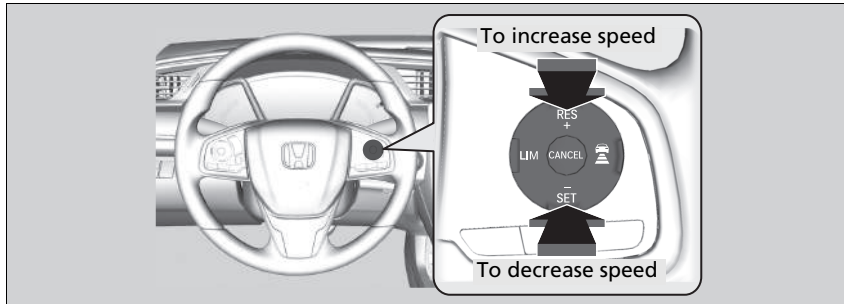

- Each time you press the button, the speed limit is increased or decreased by about 1 km/h or 1 mph accordingly.
- You can increase the speed limit until +10 km/h or +5 mph on the basis of the speed limit that the traffic sign recognition system detects.
- You can decrease the speed limit until -10 km/h or -5 mph on the basis of the speed limit that the traffic sign recognition system detects.
- You can accelerate until the set speed is reached. If your vehicle speed is higher than the speed limit that the traffic sign recognition system detects, your vehicle decelerates slowly to the speed limit.

## ■ Exceeding the Speed Limit Temporarily

The speed limit can be exceeded by depressing the accelerator pedal fully.

- ▶ The displayed speed limit blinks.
  - The beeper sounds once the speed limit has been exceeded.

## ☒ To Adjust the Speed Limit

A negative or positive offset with respect to the speed limit will be reset automatically when the traffic sign recognition system detects the new speed limit sign.

You cannot decrease the speed limit less than 30 km/h (18 mph).

## ☒ Exceeding the Speed Limit Temporarily

The beeper sounds when the vehicle speed goes higher than the set speed limit with the accelerator pedal depressed completely.

The intelligent speed limiter resumes working once the vehicle speed goes lower than the set speed limit.

### ■ To Cancel

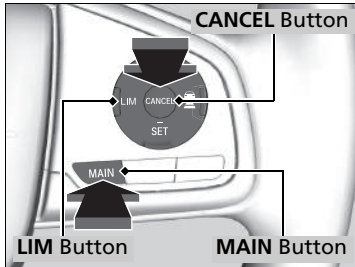

To cancel the intelligent speed limiter, do any of the following:

- Press the **CANCEL** button.
- Press the **MAIN** button.
- Press the **LIM** button.

### ▣ To Cancel

The intelligent speed limiter changes into cruise control if the **LIM** button is pressed.

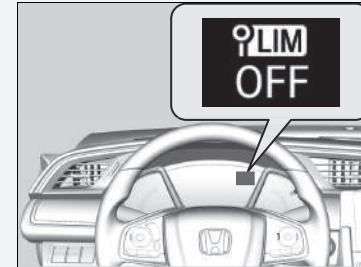

If there is a problem with the system or traffic sign recognition system when you are using the intelligent speed limiter, the beeper sounds and **OFF** comes on. The intelligent speed limiter will be turned off.

➤ **Traffic Sign Recognition System** P. 623

## Vehicle Stability Assist (VSA) System

VSA helps to stabilise the vehicle during cornering if the vehicle turns more or less than what was intended. It also assists in maintaining traction on slippery surfaces. It does so by regulating engine output and selectively applying the brakes.

### VSA Operation

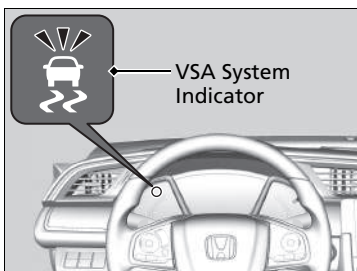

When VSA activates, you may notice that the engine does not respond to the accelerator. You may also notice some noise from the hydraulic brake system. You will also see the indicator blink.

### Vehicle Stability Assist (VSA) System

The VSA may not function properly if tyre type and size are mixed. Make sure to use the same size and type of tyre, and the air pressures as specified.

When the VSA system indicator comes on and stays on while driving, there may be a problem with the system. While this may not interfere with normal driving, have your vehicle checked by a dealer immediately.

VSA cannot enhance stability in all driving situations and does not control the entire braking system. You still need to drive and corner at speeds appropriate for the conditions and always leave a sufficient margin of safety.

The main function of the VSA system is generally known as Electronic Stability Control (ESC). The system also includes a traction control function.

The indicators for the Adaptive Cruise Control (ACC)\*, Adaptive Cruise Control (ACC) with Low Speed Follow\*, Road Departure Mitigation\*, Vehicle Stability Assist (VSA) System, Vehicle Stability Assist (VSA) OFF, Deflation Warning System\*, Low Tyre Pressure/Deflation Warning System\* and Collision Mitigation Braking System (CMBS)\* may come on after reconnecting the battery. Drive a short distance at more than 20 km/h (12 mph). The indicator should go off. If it does not, have your vehicle checked by a dealer.



## ■ VSA On and Off

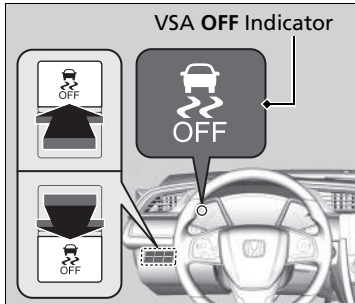

This button is on the driver side control panel. To partially disable VSA functionality/ features, press and hold it until you hear a beep.

Your vehicle will have normal braking and cornering ability, but traction control function will be less effective.

To restore VSA functionality/features, press the  (VSA **OFF**) button until you hear a beep.

VSA is turned on every time you start the engine, even if you turned it off the last time you drove the vehicle.

## ▣ Vehicle Stability Assist (VSA) System

In certain unusual conditions when your vehicle gets stuck in shallow mud or fresh snow, it may be easier to free it with the VSA temporarily switched off.

When the  button is pressed, the traction control function becomes less effective. This allows for the wheels to spin more freely at low speed. You should only attempt to free your vehicle with the VSA off if you are not able to free it when the VSA is on.

Immediately after freeing your vehicle, be sure to switch VSA on again. We do not recommend driving your vehicle with the VSA system switched off.

You may hear a motor sound coming from the engine compartment while system checks are being performed immediately after starting the engine or while driving. This is normal.

**2.0 L engine models**

**■ When the drive mode is in +R mode**

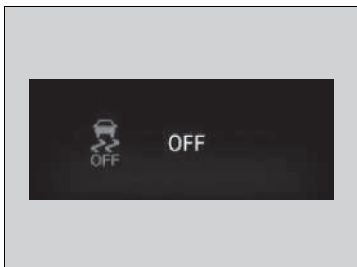

To completely disable VSA, the VSA must be in **+R** mode. Press and hold the VSA OFF button until you hear a single beep, then later two more beeps.

- ▶ This message appears on the driver information interface.

To resume VSA full function, press the VSA OFF button until a single beep is heard.

If VSA OFF mode is selected, and drive mode is changed to a mode other than **+R**, VSA full function will resume, and the VSA OFF indicator will go off.

**☒ When the drive mode is in +R mode**

In OFF mode, your vehicle will have normal braking and cornering ability, but it will not have VSA traction and stability enhancement.

When the VSA system is off, the traction control system is also off.

We do not recommend driving your vehicle with the VSA and traction control system switched off.

**Models with Honda Sensing**

When you completely disable VSA, you cannot use Adaptive Cruise Control (ACC) or the Lane Keeping Assist System (LKAS). If either feature is in use when you completely disable VSA, the feature in use will automatically be cancelled.

Road Departure Mitigation System, Collision Mitigation Braking System (CMBS), and Traffic Sign Recognition System do not function while VSA is completely disabled.

## Agile Handling Assist

Lightly brakes the front wheels, as needed, when you turn the steering wheel, and helps support the vehicle's stability and performance during cornering.

### ▣ Agile Handling Assist

The agile handling assist cannot enhance stability in all driving situations. You still need to drive and corner at speeds appropriate for the conditions and always leave a sufficient margin of safety.

When the VSA system indicator comes on and stays on while driving, the agile handling assist does not activate.

You may hear a sound coming from the engine compartment while the agile handling assist is activated. This is normal.

2.0 L engine models

## Limited Slip Differential (LSD)

LSD (limited slip differential) is a type of differential that delivers extra torque to the wheel or the wheels with the most traction to minimise wheel slip and maintain control of the vehicle.

⌘ Limited Slip Differential (LSD)

### NOTICE

Make sure both front tyres of your vehicle are of the same brand and specified size, and have equal wear. Otherwise, the LSD may not function properly.

Models with rear fog light

## Deflation Warning System

Instead of directly measuring the pressure in each tyre, the deflation warning system on this vehicle monitors and compares the rolling radius and rotational characteristics of each wheel and tyre while you are driving to determine if one or more tyres are significantly under-inflated.

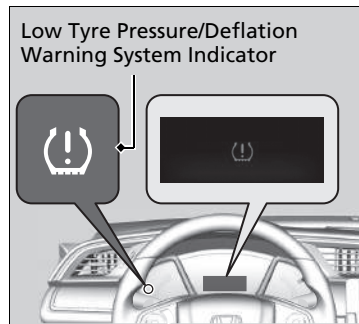

This will cause the low tyre pressure/deflation warning system indicator to come on and a message to appear on the driver information interface.

### »» Deflation Warning System

The system does not monitor the tyres when driving at low speed.

Conditions such as low ambient temperature and altitude change directly affect tyre pressure and can trigger the low tyre pressure/deflation warning system indicator to come on.

Tyre pressure checked and inflated in:

- Warm weather can become under-inflated in colder weather.
- Cold weather can become over-inflated in warmer weather.

The low tyre pressure/deflation warning system indicator will not come on as a result of over inflation.

The deflation warning system may not function properly if tyre types and sizes are mixed.

Make sure to use the same size and type of tyre.

▶ **Checking and Maintaining Tyres** P. 716

The low tyre pressure/deflation warning system indicator may come on with a delay or may not come on at all when:

- You rapidly accelerate, decelerate, or turn the steering wheel.
- You drive on snowy or slippery roads.
- Tyre chains\* are used.

The low tyre pressure/deflation warning system indicator may come on under the following conditions:

- A compact spare tyre\* is used.
- There is a heavier and uneven load on the tyres, such as when towing a trailer, than the condition at initialisation.
- Tyre chains\* are used.

\* Not available on all models

## Deflation Warning System Initialisation

You must start deflation warning system initialisation every time you:

- Adjust the pressure in one or more tyres.
- Rotate the tyres.
- Replace one or more tyres.

Before initialising the deflation warning system:

- Set the cold tyre pressure in all four tyres.

➤ **Checking Tyres** P. 716

Make sure:

- The vehicle is at a complete stop.

### Manual transmission models

- The shift lever is in **[N]**.

### Continuously variable transmission models

- The shift lever is in **[P]**.

### All models

- The ignition switch is in ON **[II]**\*1.

\*1: Models with the keyless access system have an **ENGINE START/STOP** button instead of an ignition switch.

\* Not available on all models

## Deflation Warning System Initialisation

Deflation Warning System cannot be initialised if a compact spare tyre\* is installed.

The initialisation process requires approximately 30 minutes of cumulative driving at speeds between 48–105 km/h (30–65 mph).

During this period, if the ignition is turned on and the vehicle is not moved within 45 seconds, you may notice the low tyre pressure/deflation warning system indicator comes on briefly. This is normal and indicates that the initialisation process is not yet complete.

If tyre chains\* are installed, remove them before initialising the deflation warning system.

If the low tyre pressure/deflation warning system indicator comes on even when the properly inflated specified regular tyres are installed, have your vehicle checked by a dealer.

We recommend that the tyres be replaced with the same brand, model, and size as the originals. Ask a dealer for details.

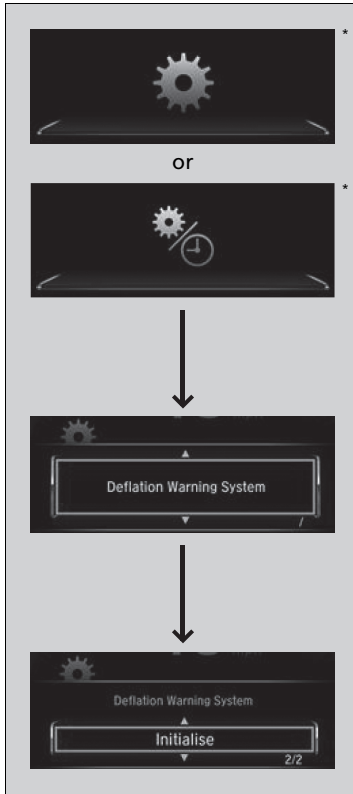

**Models without Display Audio**

You can initialise the system from the customized features on the driver information interface.

1. Press the button and press button to select , then press the **ENTER** button.
  - ▶ **Deflation Warning System** appears on the display.
2. Press the **ENTER** button.
  - ▶ The display switches to the customization setup screen, where you can select **Cancel** or **Initialise**.
3. Press the button and select **Initialise**, then press the **ENTER** button.
  - ▶ **Completed** screen appears, then the display returns to the customization menu screen.

- If the **Failed** message appears, repeat steps 2–3.
- The initialisation process finishes automatically.

\* Not available on all models

Continued

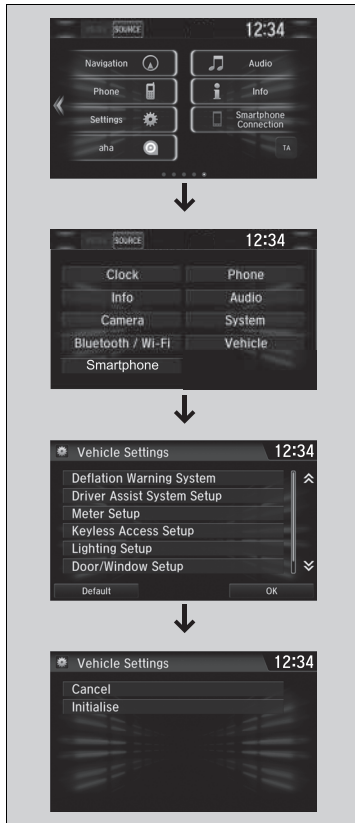

▶▶ Deflation Warning System Initialisation

The indicators for the Adaptive Cruise Control (ACC)\*, Adaptive Cruise Control (ACC) with Low Speed Follow\*, Road Departure Mitigation\*, Vehicle Stability Assist (VSA) System, Vehicle Stability Assist (VSA) OFF, Low Tyre Pressure/Deflation Warning System and Collision Mitigation Braking System (CMBS)\* may come on after reconnecting the battery. Drive a short distance at more than 20 km/h (12 mph). The indicator should go off. If it does not, have your vehicle checked by a dealer.



**Models with Display Audio**

You can initialise the system from the customized feature on the audio/information screen.

1. Turn the ignition switch to ON \*1.
2. Select .
3. Select **Settings**.
4. Select **Vehicle**.
5. Select **Deflation Warning System**.
6. Select **Cancel** or **Initialise**.

- If the **Failed** message appears, repeat step 6.
- The initialisation process finishes automatically.

\* 1: Models with the keyless access system have an **ENGINE START/STOP** button instead of an ignition switch.



Models without rear fog light

## Deflation Warning System

Monitors tyre revolutions while you are driving over 30 km/h.

When there is a change in tyre revolutions, the system detects a decrease in tyre pressure.

### ■ Deflation Warning System Initialisation

For proper use, initialise the system after the tyres are:

- Inflated to the recommended pressures
- Changed or rotated

### ▣ Deflation Warning System

When a decrease in tyre pressure is detected, the deflation warning system indicator comes on with  on the driver information interface.

➤ **Deflation Warning System Indicator** P. 119

The deflation warning system may not function properly if tyre types and sizes are mixed.

Make sure to use the same size and type of tyre.

➤ **Checking and Maintaining Tyres** P. 716

*Continued*

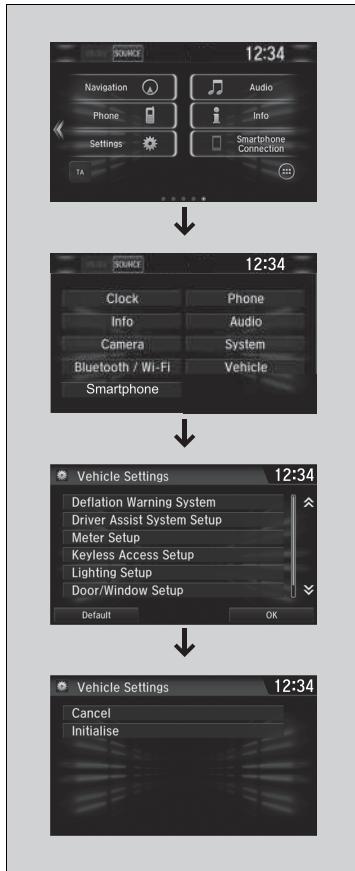

You can initialise the system from the customized feature on the audio/information screen.

1. Set the power mode to ON.
  2. Select **HOME**.
  3. Select **Settings**.
  4. Select **Vehicle**.
  5. Select **Deflation Warning System**.
  6. Select **Cancel** or **Initialise**.
- If the **Failed** message appears, repeat step 6.
  - The initialisation process finishes automatically.

## ■ Deflation Warning System Indicator

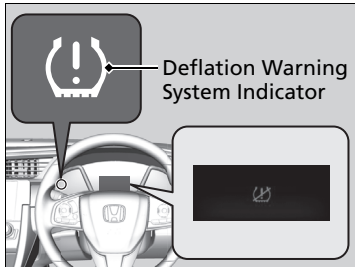

### ■ The indicator may come on under the following conditions:

- Any of the tyre's pressures is low.
- The system has not been initialised.
- A compact spare tyre is used.
- There is a heavier and uneven load on the tyres, such as when towing a trailer, than the condition at initialisation.

### ▣ Deflation Warning System Indicator

The indicator may come on with a delay or may not come on at all when:

- Two or more tyre's pressure are low.
- You rapidly accelerate, decelerate, or turn the steering wheel.
- You drive on snowy or slippery roads.
- Tyre chains\* are used.

The indicators for the Vehicle Stability Assist (VSA) System, Vehicle Stability Assist (VSA) OFF and Deflation Warning System may come on after reconnecting the battery. Drive a short distance at more than 20 km/h. The indicator should go off. If it does not, have your vehicle checked by a dealer.

\* Not available on all models

## Blind spot information System\*

Is designed to detect vehicles in specified alert zones adjacent to your vehicle, particularly in harder to see areas commonly known as "blind spots." When the system detects vehicles approaching from behind in adjacent lanes, the appropriate indicator comes on for a few seconds, providing assistance when you change lanes.

### Blind spot information System\*

#### **WARNING**

Failure to visually confirm that it is safe to change lanes before doing so may result in a crash and serious injury or death.

Do not rely only on the blind spot information system when changing lanes.

Always look in your mirrors, to either side of your vehicle, and behind you for other vehicles before changing lanes.

#### **Important Safety Reminder**

Like all assistance systems, blind spot information system has limitations. Over reliance on blind spot information system may result in a collision.

The blind spot information system alert indicator may not come on under the following conditions:

- A vehicle does not stay in the alert zone for more than two seconds.
- A vehicle is parked in a side lane.
- The speed difference between your vehicle and the vehicle you are passing is greater than 10 km/h (6 mph).
- An object not detected by the radar sensors approaches or passes your vehicle.
- A vehicle running in the adjacent lane is a motorcycle or other small vehicle.

## ■ How the system works

- Radar sensors detect a vehicle in the alert zone when your vehicle is moving forward at 20 km/h (12 mph) or faster.

### Alert zone range

- A: Approx. 0.5 m (1.6 ft.)
- B: Approx. 3 m (10 ft.)
- C: Approx. 3 m (10 ft.)

Radar Sensors:  
underneath the  
rear bumper  
corners

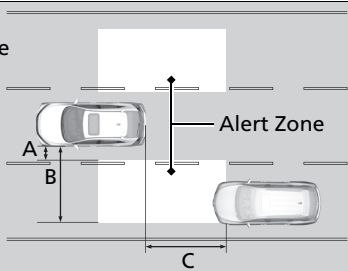

## ▣ Blind spot information System \*

The system is for your convenience only. Even if an object is within the alert zone, the following situations may occur.

- The blind spot information system alert indicator may not come on due to obstruction (splashes, etc.) even without the driver information interface appearing.
- The blind spot information system alert indicator may come on even with the message appearing.

You can turn off the audible alert, or all the blind spot information system alert using the driver information interface or audio/information screen.

➤ **Customized Features\*** P. 171, 396

Turn the system off when towing a trailer\*.

The system may not work properly for the following reasons:

- The added mass tilts the vehicle and changes the radar coverage.
- The trailer itself can be detected by the radar sensors, causing the blind spot information system alert indicators to come on.

\* Not available on all models

### ■ When the system detects a vehicle

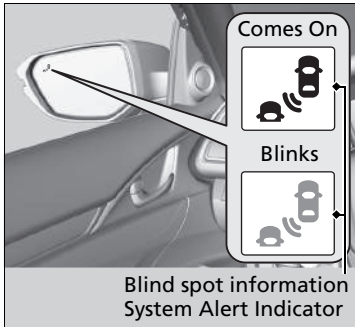

Blind spot information System Alert Indicator: Located on the outside rearview mirror on both sides.

#### Comes on when:

- A vehicle enters the alert zone from behind to overtake you with a speed difference of no more than 50 km/h (31 mph) from your vehicle.
- You pass a vehicle with a speed difference of no more than 20 km/h (12 mph).

#### Blinks and a beeper sounds when:

You move the turn signal lever in the direction of the detected vehicle. The beeper sounds three times.

### ▣ Blind spot information System\*

Blind spot information system may be adversely affected when:

- Objects (guard rails, poles, trees, parked vehicles, building, wall, etc) are detected.
- An object that does not reflect radio waves well, such as a motorcycle, is in the alert zone.
- Driving on a curved road.
- A vehicle is moving from a far lane to the adjacent lane.
- The system picks up external electrical interference.
- The rear bumper or the sensors have been improperly repaired or the rear bumper has been deformed.
- The orientation of the sensors has been changed.
- In bad weather (rain, snow, and fog).
- Driving on a bumpy road.
- Making a short turn that slightly tilts the vehicle.

For a proper blind spot information system operation:

- Always keep the rear bumper corner area clean.
- Do not cover the rear bumper corner area with labels or stickers of any kind.
- Take your vehicle to a dealer if you need the rear bumper corner area or the radar sensors to be repaired, or the rear bumper corner area is strongly impacted.

## LaneWatch\*

LaneWatch is an assistance system that allows you to check the passenger side rear areas displayed on the audio/information screen when the turn signal is activated to the passenger's side. A camera in the passenger side door mirror monitors these areas and allows you to check for vehicles, in addition to your visual check and use of the passenger door mirror. You can also keep the system on for your convenience while driving.

**2** The passenger side view display appears on the audio/information screen.



**1** The system activates when you:

Move the turn signal lever to the passenger side.



Press the LaneWatch button.



The system deactivates when you press the LaneWatch button again.

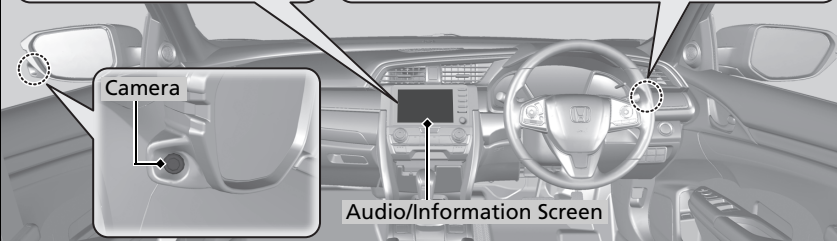

Camera

Audio/Information Screen

### LaneWatch\*

## ⚠ WARNING

Failure to visually confirm that it is safe to change lanes before doing so may result in a crash and serious injury or death.

Do not rely only on LaneWatch while driving.

Always look in your mirrors, to either side of your vehicle, and behind you for other vehicles before changing lanes.

### Important Safety Reminder

Like all assistance systems, LaneWatch has limitations. Over reliance on LaneWatch may result in a collision.

The LaneWatch function can be affected by weather, lighting (including headlights and low sun angle), ambient darkness, camera condition, and loading.

The LaneWatch may not provide the intended display of traffic to the side and rear under the following conditions:

- Your vehicle's suspension has been altered, changing the height of the vehicle.
- Your tyres are over or under inflated.
- Your tyres or wheels are of varied size or construction.

\* Not available on all models

Continued

### ■ Customizing the LaneWatch settings

You can customize the following items using the audio/information screen.

- **Show with Turn Signal:** Selects whether LaneWatch monitor comes on when you operate the turn signal lever.
- **Display Time after Turn Signal Off:** Changes the length of time the LaneWatch display stays on after you pull the turn signal lever back.
- **Reference Line:** Selects whether the reference lines appear on the LaneWatch monitor.
- **Display:** Allows for display adjustments of items, such as brightness, contrast and black level. This setting is part of the **System** setup group.
  - ☒ **Customized Features** P. 396

### ■ Reference Lines

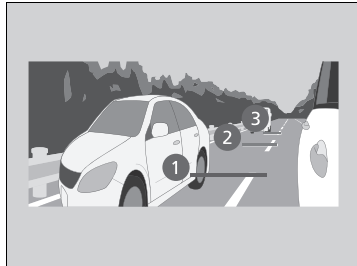

Three lines that appear on the screen can give an idea of how far the vehicles or objects on the screen are from your vehicle, respectively. If an object is near line 1 (in red), it indicates that it is close to your vehicle whereas an object near line 3 is farther away.

### ☒ LaneWatch\*

The LaneWatch camera view is restricted. Its unique lens makes objects on the screen look slightly different from what they are.

LaneWatch display does not come on when the shift lever is in **[R]**.

For proper LaneWatch operation:

- The camera is located in the passenger side door mirror. Always keep this area clean. If the camera lens is covered with dirt or moisture, use a soft, moist cloth to keep the lens clean and free of debris.
- Do not cover the camera lens with labels or stickers of any kind.
- Do not touch the camera lens.

### ☒ Reference Lines

The area around the reference line 1 (red) is very close to your vehicle. As always, make sure to visually confirm the safety of a lane change before changing lanes.

The distance between your vehicle and lines 1, 2 and 3 on the screen vary depending on road conditions and vehicle loading. For example, the reference lines on the screen may seem to appear closer than the actual distances when the rear of your vehicle is more heavily loaded.

Consult a dealer if:

- The passenger side door mirror, or area around it is severely impacted, resulting in changing the camera angle.
- The LaneWatch display does not come on at all.



## Adjusting Headlight Distribution

Driving the right-hand type vehicle in right-hand traffic, or the left-hand type vehicle in left-hand traffic causes headlight glare to oncoming vehicles. You need to alter the headlight beam distribution using masking tape.

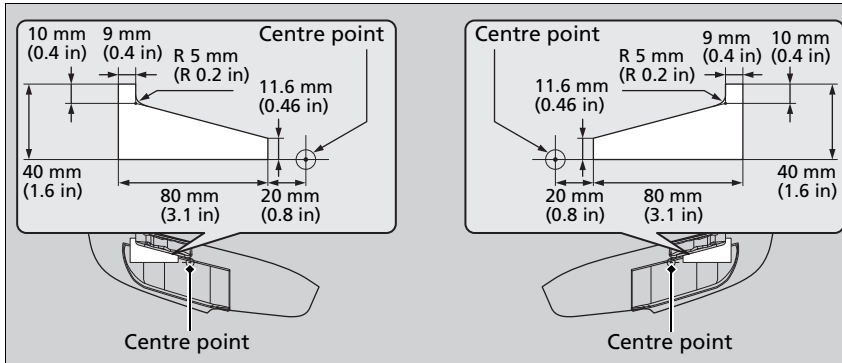

1. Prepare for two rectangular pieces of masking tape, measuring 40 mm (1.6 in) wide and 80 mm (3.1 in) long.
  - ▶ Use masking tape that can shut out light, such as seal type waterproof vinyl.
2. Affix the tape to the lens as shown.

### Adjusting Headlight Distribution

Be careful not to adhere the tape to an incorrect location. If the headlight beam is distributed incorrectly, it may not comply with your country's legal requirements. Ask your dealer for details.

# Honda Sensing\*

Honda Sensing is a driver support system which employs the use of two distinctly different kinds of sensors: a radar sensor located in the lower bumper and a front sensor camera mounted to the interior side of the windscreen, behind the rearview mirror.

Honda Sensing has following functions.

## ■ The functions which do not require switch operations to activate

- Collision Mitigation Braking System (CMBS) ➡ P. 565
- Road Departure Mitigation System ➡ P. 617

## ■ The functions which require switch operations to activate

### Continuously variable transmission models

- Adaptive Cruise Control (ACC) with Low Speed Follow ➡ P. 576

### Manual transmission models

- Adaptive Cruise Control (ACC) ➡ P. 593
- Lane Keeping Assist System (LKAS) ➡ P. 609
- Traffic Sign Recognition System ➡ P. 623

## ■ Operation Switches for the ACC with Low Speed Follow\*/ACC\*/LKAS

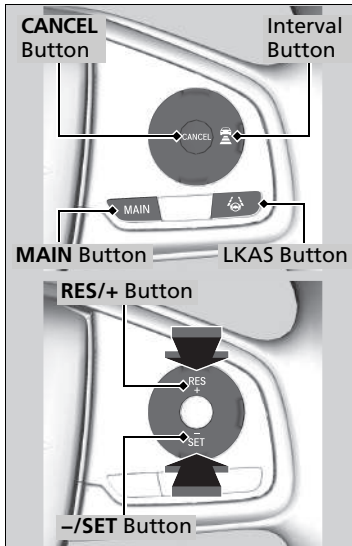

### ■ MAIN Button

Press to activate standby mode for ACC with Low Speed Follow\*/ACC\* and LKAS. Or press to cancel these systems.

### ■ LKAS Button

Press to activate or cancel the LKAS.

### ■ RES/+/-/SET Button

Press **RES/+** to resume the ACC with Low Speed Follow\*/ACC\* or increase the vehicle speed.

Press **-/SET** to set the ACC with Low Speed Follow\*/ACC\* or decrease the vehicle speed.

### ■ Interval Button

Press the  (interval) button to change the ACC with Low Speed Follow\*/ACC\* following-interval.

### ■ CANCEL Button

Press to cancel ACC with Low Speed Follow\*/ACC\*.

\* Not available on all models

Continued

## Driver Information Interface Content

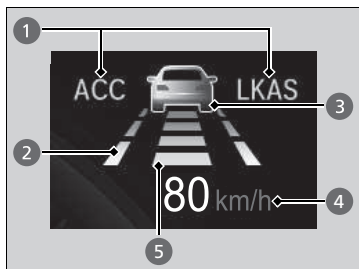

You can see the current state of ACC with Low Speed Follow\*/ACC\* and LKAS.

- 1 Indicates that ACC with Low Speed Follow\*/ACC\* and LKAS are ready to be activated.
- 2 Indicates that LKAS is activated and whether or not traffic lane lines are detected.
- 3 Indicates whether or not a vehicle is detected ahead.
- 4 Shows the set vehicle speed.
- 5 Shows the set vehicle interval.

## Collision Mitigation Braking System (CMBS)

Can assist you when there is a possibility of your vehicle colliding with a vehicle or a pedestrian detected in front of yours. The CMBS is designed to alert you when the potential for a collision is determined, as well as to reduce your vehicle speed to help minimise collision severity when a collision is deemed unavoidable.

### ▶▶ Collision Mitigation Braking System (CMBS)

#### Manual transmission models

When the CMBS activates, the engine may stop automatically.

Start the engine by normal operation if the engine stops.

▶ **Starting the Engine** P. 493, 496

#### Important Safety Reminder

The CMBS is designed to reduce the severity of an unavoidable collision. It does not prevent collision nor stop the vehicle automatically. It is still your responsibility to operate the brake pedal and steering wheel appropriately according to the driving conditions.

The CMBS may not activate or may not detect a vehicle in front of your vehicle under certain conditions:

▶ **CMBS Conditions and Limitations** P. 570

You can read about handling information for the camera equipped with this system.

▶ **Front Sensor Camera** P. 630

For directions on the proper handling of the radar sensor, refer to the following page.

▶ **Radar Sensor** P. 632

## ■ How the system works

### When to use

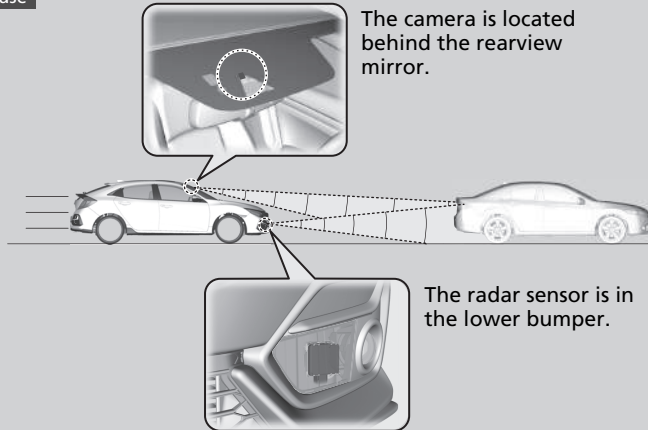

The system starts monitoring the roadway ahead when your vehicle speed is about 5 km/h (3 mph) and there is a vehicle in front of you.

The CMBS activates when:

- The speed difference between your vehicle and a vehicle or pedestrian detected in front of you becomes about 5 km/h (3 mph) and over with a chance of a collision.
- Your vehicle speed is about 100 km/h (62 mph) or less and the system determines there is a chance of a collision with:
  - Vehicles detected in front of you that are stationary, oncoming, or travelling in your same direction.
  - A pedestrian who is detected in front of you.
- Your vehicle speed is above 100 km/h (62 mph), and the system determines there is a chance of a collision with a vehicle detected in front of you travelling in your same direction.

### ☒ Collision Mitigation Braking System (CMBS)

When the CMBS activates, it may automatically apply the brake. It will be cancelled when your vehicle stops or a potential collision is not determined.

#### 2.0 L engine models

CMBS does not function while VSA is completely disabled.

### ■ When the system activates

The system provides visual and audible alerts of a possible collision, and stops if the collision is avoided.

- ▶ Take appropriate action to prevent a collision (apply the brakes, change lanes, etc.)

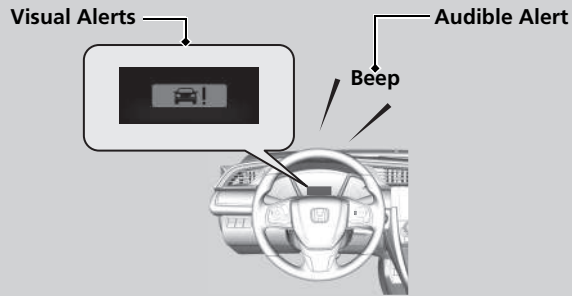

At system's earliest collision alert stage, you can change the distance (**Far/Normal/Near**) between vehicles at which alerts will come on through driver information interface or audio/information screen\* setting options.

- ▶ **Customized Features\*** P. 171, 396

### ▣ When the system activates

The camera in the CMBS is also designed to detect pedestrians.

However, this pedestrian detection feature may not activate or may not detect a pedestrian in front of your vehicle under certain conditions.



Refer to the ones indicating the pedestrian detection limitations from the list.

- ▶ **CMBS Conditions and Limitations** P. 570

\* Not available on all models

## Collision Alert Stages

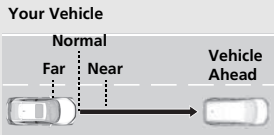
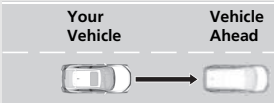
The system has three alert stages for a possible collision. However, depending on circumstances, the CMBS may not go through all of the stages before initiating the last stage.

Distance between vehicles		CMBS		
		The radar sensor detects a vehicle	Audible & Visual WARNINGS	Braking
Stage one		There is a risk of a collision with the vehicle ahead of you.	When in <b>Far</b> , visual and audible alerts come on at a longer distance from a vehicle ahead than in <b>Normal</b> setting, and in <b>Near</b> , at a shorter distance than in <b>Normal</b> .	—
Stage two		The risk of a collision has increased, time to respond is reduced.	Visual and audible alerts.	Lightly applied
Stage three		The CMBS determines that a collision is unavoidable.		Forcefully applied



## ■ CMBS On and Off

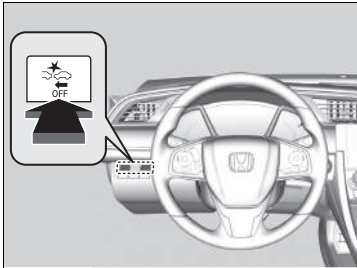

Press and hold the button until the beeper sounds to switch the system on or off.

When the CMBS is off:

- The CMBS indicator in the instrument panel comes on.
- A message on the driver information interface reminds you that the system is off.

The CMBS is turned on every time you start the engine, even if you turned it off the last time you drove the vehicle.

## ▣ Collision Mitigation Braking System (CMBS)

The CMBS may automatically shut off, and the CMBS indicator will come and stay on under certain conditions:

▣ **CMBS Conditions and Limitations** P. 570

When the CMBS is activated, it will continue to operate even if the accelerator pedal is partially depressed. However, it will be cancelled if the accelerator pedal is deeply depressed.

The indicators for the Adaptive Cruise Control (ACC)\*, Adaptive Cruise Control (ACC) with Low Speed Follow\*, Road Departure Mitigation, Vehicle Stability Assist (VSA) System, Vehicle Stability Assist (VSA) OFF, Low Tyre Pressure/Deflation Warning System and Collision Mitigation Braking System (CMBS) may come on after reconnecting the battery. Drive a short distance at more than 20 km/h (12 mph). The indicator should go off. If it does not, have your vehicle checked by a dealer.

\* Not available on all models

## ■ CMBS Conditions and Limitations

The system may automatically shut off and the CMBS indicator will come on under certain conditions. Some examples of these conditions are listed below. Other conditions may reduce some of the CMBS functions.

📷 **Front Sensor Camera** P. 630

### ■ Environmental conditions

- Driving in bad weather (rain, fog, snow, etc.).
- Sudden changes between light and dark, such as an entrance or exit of a tunnel.
- There is little contrast between objects and the background.
- Driving into low sunlight (e.g., at dawn or dusk).
- Strong light is reflected onto the roadway.
- Driving in the shadows of trees, buildings, etc.
- Roadway objects or structures are misinterpreted as vehicles and pedestrians.
- Reflections on the interior of the windshield.
- Driving at night or in a dark place such as a tunnel (due to low-light conditions, pedestrians or other vehicles may not be detected).

### ■ Roadway conditions

- Driving on a snowy or wet roadway (obscured lane marking, vehicle tracks, reflected lights, road spray, high contrast).
- Driving on curvy, winding, or undulating roads.
- The road is hilly or the vehicle is approaching the crest of a hill.

### 📷 CMBS Conditions and Limitations

Have your vehicle checked by a dealer if you find any unusual behavior of the system (e.g., the warning message appears too frequently).

**■ Vehicle conditions**

- Headlight lenses are dirty or the headlights are not properly adjusted.
- The outside of the windscreen is blocked by dirt, mud, leaves, wet snow, etc.
- The inside of the windscreen is fogged.
- An abnormal tyre or wheel condition (wrong sized, varied size or construction, improperly inflated, compact spare tyre\*, etc.).
- When tyre chains\* are installed.
- The vehicle is tilted due to a heavy load or suspension modifications.
- The camera temperature gets too high.
- Driving with the parking brake applied.
- When the radar sensor in the lower bumper gets dirty.
- Driving at night or in a dark place (e.g., a tunnel) with the headlights off.

**1.0 L engine models with climate control system**

- The vehicle is towing a trailer.

**■ Detection limitations**

- A vehicle or pedestrian suddenly crosses in front of you.
- The distance between your vehicle and the vehicle or pedestrian ahead of you is too short.
- A vehicle cuts in front of you at a slow speed, and it brakes suddenly.
- When you accelerate rapidly and approach the vehicle or pedestrian ahead of you at high speed.
- The vehicle ahead of you is a motorcycle, bicycle, mobility scooter, or other small vehicle.
- When there are animals in front of your vehicle.

\* Not available on all models

- When you drive on a curved, winding or undulating road that makes it difficult for the sensor to properly detect a vehicle in front of you.
- The speed difference between your vehicle and a vehicle or pedestrian in front of you is significantly large.
- An oncoming vehicle suddenly comes in front of you.
- Another vehicle suddenly comes in front of you at an intersection, etc.
- Your vehicle abruptly crosses over in front of an oncoming vehicle.
- When driving through a narrow iron bridge.
- When the lead vehicle suddenly slows down.

**Limitations applicable to pedestrian detection only**

- When there is a group of people in front of your vehicle walking together side by side.
- Surrounding conditions or belongings of the pedestrian alter the pedestrian's shape, preventing the system from recognizing that the person is a pedestrian.
- When the pedestrian is shorter than about 1 metre or taller than about 2 metres in height.
- When a pedestrian blends in with the background.
- When a pedestrian is bent over or squatting, or when their hands are raised or they are running.
- When several pedestrians are walking ahead in a group.
- When the camera cannot correctly identify that a pedestrian is present due to an unusual shape (holding luggage, body position, size).

### ■ Automatic shutoff

The CMBS may automatically shut itself off and the CMBS indicator comes and stays on when:

- The temperature inside the system is high.
- You drive off-road or on a mountain road, or curved and winding road for an extended period.
- An abnormal tyre condition is detected (wrong tyre size, flat tyre, etc.).
- The camera behind the rearview mirror, or the area around the camera, including the windscreen, gets dirty.

Once the conditions that caused the CMBS to shut off improve or are addressed (e.g., cleaning), the system comes back on.

### ■ With Little Chance of a Collision

The CMBS may activate even when you are aware of a vehicle ahead of you, or when there is no vehicle ahead. Some examples of this are:

#### ■ When Passing

Your vehicle approaches another vehicle ahead of you and you change lanes to pass.

#### ■ At an intersection

Your vehicle approaches or passes another vehicle that is making a left or right turn.

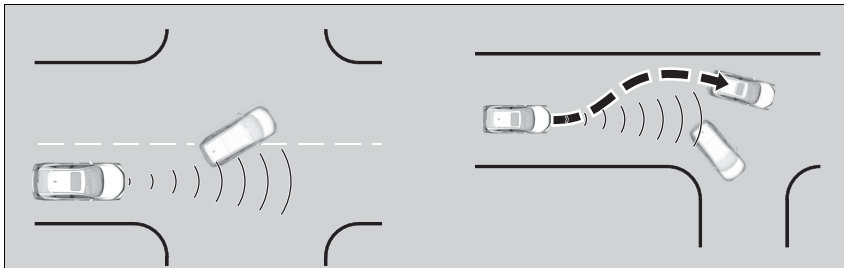

### ☒ With Little Chance of a Collision

Do not paint, or apply any coverings or paint to radar sensor area. This can impact CMBS operation.

■ **On a curve**

When driving through curves, your vehicle comes to a point where an oncoming vehicle is right in front of you.

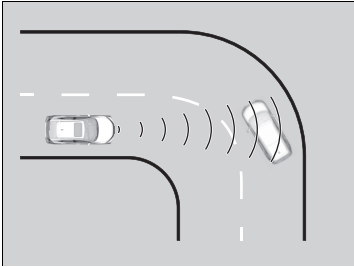

■ **Through a low bridge at high speed**

You drive under a low or narrow bridge at high speed.

■ **Speed bumps, road work sites, train tracks, roadside objects, etc.**

You drive over speed bumps, steel road plates, etc., or your vehicle approaches train tracks or roadside objects (such as a traffic sign and guard rail) on a curve or, when parking, stationary vehicles and walls.

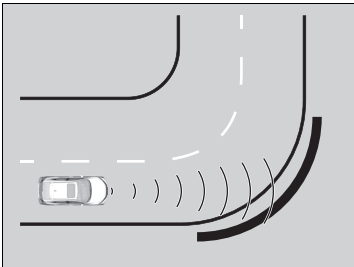

Continuously variable transmission models

## Adaptive Cruise Control (ACC) with Low Speed Follow

Helps maintain a constant vehicle speed and a set following-interval behind a vehicle detected ahead of yours and, if the detected vehicle comes to a stop, can decelerate and stop your vehicle, without you having to keep your foot on the brake or the accelerator.

When ACC with Low Speed Follow slows your vehicle by applying the brakes, your vehicle's brake lights will illuminate.

### When to use

The camera is located behind the rearview mirror.

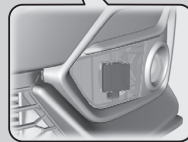
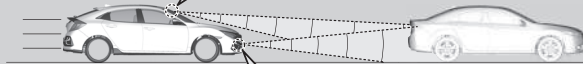
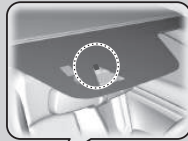

The radar sensor is in the lower bumper. Be careful not to hit the radar sensor cover. Strong impact can damage it.

- Vehicle speed for ACC with Low Speed Follow: **A vehicle is detected ahead within ACC with Low Speed Follow range** – ACC with Low Speed Follow operates at speeds up to 180 km/h (112 mph).  
**No vehicle is detected within ACC with Low Speed Follow range** – ACC with Low Speed Follow operates at the speed of 30 km/h (18 mph) or above.
- Shift position for ACC with Low Speed Follow: In **D** or **S**.

### Adaptive Cruise Control (ACC) with Low Speed Follow

#### ⚠ WARNING

Improper use of ACC with Low Speed Follow can lead to a crash.

Use ACC with Low Speed Follow only when driving on motorways and in good weather conditions.

#### ⚠ WARNING

ACC with Low Speed Follow has limited braking capability and may not stop your vehicle in time to avoid a collision with a vehicle that quickly stops in front of you.

Always be prepared to apply the brake pedal if the conditions require.

#### Important Reminder

As with any system, there are limits to ACC with Low Speed Follow. Use the brake pedal whenever necessary, and always keep a safe interval between your vehicle and other vehicles.

For directions on the proper handling of the radar sensor, refer to the following page.

➤ **Radar Sensor** P. 632



## ■ How to activate the system

### How to use

- Press the **MAIN** button on the steering wheel.

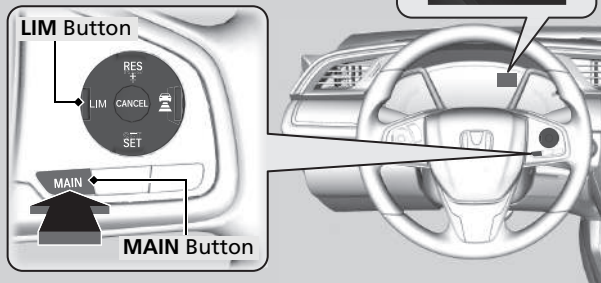

**ACC (green) is on in the instrument panel.**  
ACC with Low Speed Follow is ready to use.

If a different instrument panel is displayed, press the **LIM** button to change it to ACC with Low Speed Follow.

### ▣ Adaptive Cruise Control (ACC) with Low Speed Follow

You can read about handling information for the camera equipped with this system.

➤ **Front Sensor Camera** P. 630

The radar sensor for ACC with Low Speed Follow is shared with the collision mitigation braking system (CMBS).

➤ **Collision Mitigation Braking System (CMBS)** P. 565

When the **MAIN** button is pressed, both ACC with Low Speed Follow and the Lane Keeping Assist System (LKAS) are either turned on or off.

ACC with Low Speed Follow may not work properly under certain conditions.

➤ **ACC with Low Speed Follow Conditions and Limitations** P. 583

When not using ACC with Low Speed Follow: Turn off adaptive cruise by pressing the **MAIN** button. This also will turn off the Lane Keeping Assist System (LKAS).

## ■ To Set the Vehicle Speed

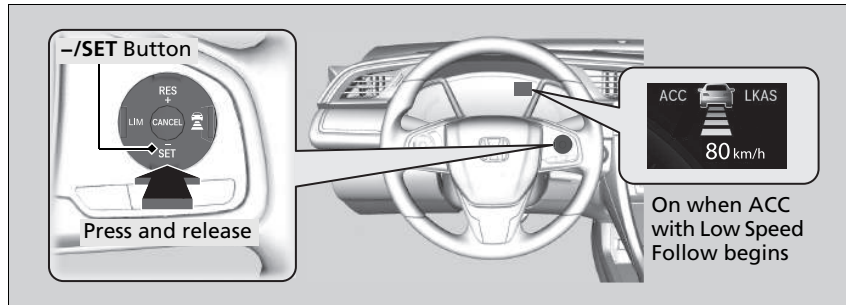

**When driving at about 30 km/h (18 mph) or above:** Take your foot off the pedal and press the -/SET button when you reach the desired speed. The moment you release the button, the set speed is fixed, and ACC with Low Speed Follow begins.

**When driving slower than about 30 km/h (18 mph):** If the vehicle is moving and the brake pedal is not depressed, pressing the button fixes the set speed to about 30 km/h (18 mph) regardless of current vehicle speed. If your vehicle is stationary, you can set the vehicle speed even with the brake pedal depressed.

## ▣ Adaptive Cruise Control (ACC) with Low Speed Follow

Do not use ACC with Low Speed Follow under the following conditions:

- On roads with heavy traffic or while driving in continuous stop and go traffic.
- On roads with sharp turns.
- On roads with steep downhill sections, as the set vehicle speed can be exceeded by coasting. In such cases, ACC with Low Speed Follow will not apply the brakes to maintain the set speed.
- On roads with toll collection facilities or other objects between lanes of traffic, or in parking areas, or facilities with drive through access.

You can switch the displayed set speed measurements on the driver information interface or audio/information screen between mph and km/h.

▣ **Customized Features\*** P. 171, 396

The indicators for the Adaptive Cruise Control (ACC) with Low Speed Follow, Road Departure Mitigation, Vehicle Stability Assist (VSA) System, Vehicle Stability Assist (VSA) OFF, Low Tyre Pressure/Deflation Warning System\* and Collision Mitigation Braking System (CMBS) may come on after reconnecting the battery. Drive a short distance at more than 20 km/h (12 mph). The indicator should go off. If it does not, have your vehicle checked by a dealer.

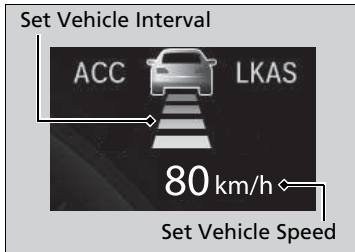

When ACC with Low Speed Follow starts operating, the vehicle icon, interval bars and set speed appear on the driver information interface.

When you use ACC with Low Speed Follow, Straight Driving Assist (a feature of the Electric Power Steering system) is activated. By enabling the steering system to automatically compensate for natural steering pull, Straight Driving Assist makes it easier for you to keep your vehicle in a straight line.

## ■ When in Operation

### ■ There is a vehicle ahead

ACC with Low Speed Follow monitors if a vehicle ahead of you enters the ACC with Low Speed Follow range. If a vehicle is detected doing so, the ACC with Low Speed Follow system maintains or decelerates your vehicle's set speed in order to keep the vehicle's set following-interval from the vehicle ahead.

🔧 To Set or Change Following-interval P. 587

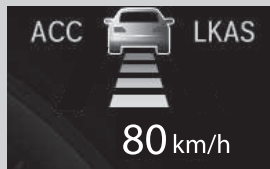
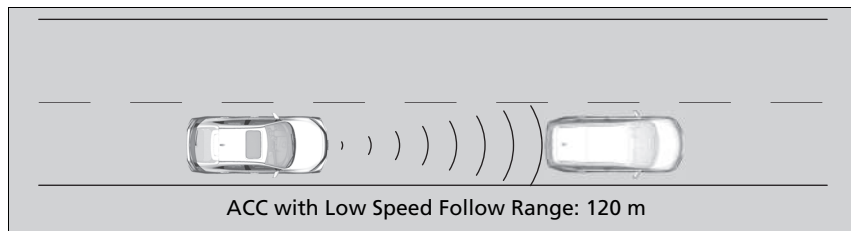

A vehicle icon appears on the driver information interface

When a vehicle whose speed is slower than your set speed comes in or cuts in front of you and is detected by the radar and the camera, your vehicle starts to slow down.

## 🔍 When in Operation

If the vehicle ahead of you slows down abruptly, or if another vehicle cuts in front of you, the beeper sounds, a message appears on the driver information interface.

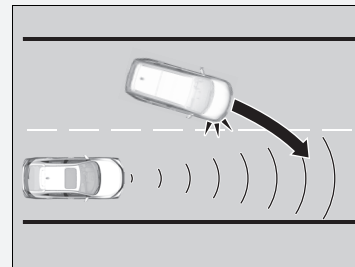

Depress the brake pedal, and keep an appropriate interval from the vehicle ahead.

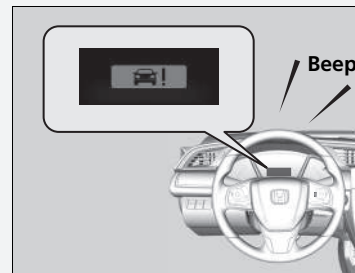

■ **There is no vehicle ahead**

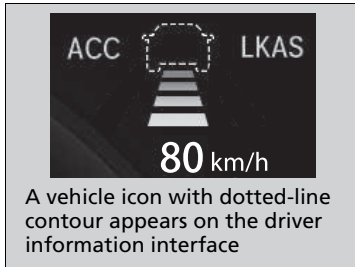

Your vehicle maintains the set speed without having to keep your foot on the brake or accelerator pedal. If there previously was a vehicle detected ahead that kept your vehicle from travelling at the set speed, ACC with Low Speed Follow accelerates your vehicle to the set speed, and then maintains it.

■ **When you depress the accelerator pedal**

You can temporarily increase the vehicle speed. In this case, there is no audible or visual alert even if a vehicle is in the ACC with Low Speed Follow range. ACC with Low Speed Follow stays on unless you cancel it. Once you release the accelerator pedal, the system resumes an appropriate speed for keeping the following-interval while a vehicle ahead is within the ACC with Low Speed Follow range.

▣ **When in Operation**

Even if the interval between your vehicle and the vehicle detected ahead is short, ACC with Low Speed Follow may start accelerating your vehicle under the following circumstances:

- The vehicle ahead of you is going at almost the same speed as, or faster than, your vehicle.
- A vehicle that cuts in front of you is going faster than your vehicle, gradually increasing the interval between the vehicles.

You can also set the system to beep when a vehicle detected in front of you comes in and goes out of the ACC with Low Speed Follow detecting range. Change the **ACC Vehicle Ahead Detected Beep** setting.

▣ **Customized Features\*** P. 171, 396

You can also set the system to beep when a vehicle detected in front of you comes in and goes out of the ACC detecting range. Change the **ACC Vehicle Ahead Detected Beep** setting.

▣ **Customized Features\*** P. 171, 396

**Limitations**

You may need to use the brake to maintain a safe interval when using ACC with Low Speed Follow. Additionally, ACC with Low Speed Follow may not work properly under certain conditions.

▣ **ACC with Low Speed Follow Conditions and Limitations** P. 583

\* Not available on all models

■ A vehicle detected ahead is within ACC with Low Speed Follow range and slows to a stop



Your vehicle also stops, automatically. The  message appears on the driver information interface.

When the vehicle ahead of you starts again, the vehicle icon on the driver information interface blinks. If you press the **RES/+** or **-/SET** button, or depress the accelerator pedal, ACC with Low Speed Follow operates again within the previously set speed.

If no vehicle is ahead of you before you resume driving, depress the accelerator pedal and ACC with Low Speed Follow will operate again within the prior set speed.

⊠ A vehicle detected ahead is within ACC with Low Speed Follow range and slows to a stop

**⚠ WARNING**

Exiting a vehicle that has been stopped while the ACC with Low Speed Follow system is operating can result in the vehicle moving without operator control.

A vehicle that moves without operator control can cause a crash, resulting in serious injury or death.

Never exit a vehicle when the vehicle is stopped by ACC with Low Speed Follow.

## ■ ACC with Low Speed Follow Conditions and Limitations

The system may automatically shut off and the **ACC** indicator will come on under certain conditions. Some examples of these conditions are listed below. Other conditions may reduce some of the ACC functions.

➤ **Front Sensor Camera** P. 630

### ■ Environmental conditions

Driving in bad weather (rain, fog, snow, etc.).

### ■ Roadway conditions

Driving on a snowy or wet roadway (obscured lane marking, vehicle tracks, reflected lights, road spray, high contrast).

### ■ Vehicle conditions

- The outside of the windscreen is blocked by dirt, mud, leaves, wet snow, etc.
- An abnormal tyre or wheel condition (Wrong sized, varied size or construction, improperly inflated, compact spare tyre\*, etc.).
- The camera temperature gets too high.
- The parking brake is applied.
- When the lower bumper is dirty.
- The vehicle is tilted due to a heavy load or suspension modifications.
- When tyre chains are installed.

## ▣ ACC with Low Speed Follow Conditions and Limitations

If you need the radar sensor to be repaired, or removed, or the radar sensor cover is strongly impacted, turn off the system by pressing the **MAIN** button and take your vehicle to a dealer.

Have your vehicle checked by a dealer if you find any unusual behavior of the system (e.g., the warning message appears too frequently).

\* Not available on all models

### ■ Detection limitations

- A vehicle suddenly crosses in front of you.
- The interval between your vehicle and the vehicle ahead of you is too short.
- A vehicle cuts in front of you at a slow speed, and it brakes suddenly.
- When you accelerate rapidly and approach the vehicle ahead of you at high speed.
- The vehicle ahead of you is a motorcycle, bicycle, mobility scooter, or other small vehicle.
- When there are animals in front of your vehicle.
- When you drive on a curved or winding or undulating road that makes it difficult for the sensor to properly detect a vehicle in front of you.

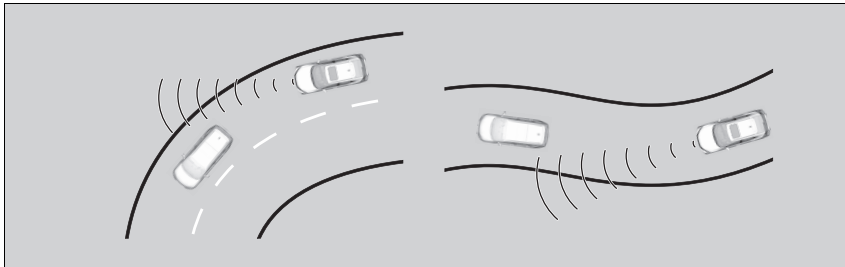

- The speed difference between your vehicle and a vehicle in front of you is significantly large.
- An oncoming vehicle suddenly comes in front of you.
- Your vehicle abruptly crosses over in front of an oncoming vehicle.

### ☒ ACC with Low Speed Follow Conditions and Limitations

If the front of the vehicle is impacted in any of the following situations, the radar sensor may not work properly. Have your vehicle checked by a dealer:

- The vehicle mounted onto bump, curb, chock, embankment, etc.
- You drive the vehicle where the water is deep.
- Your vehicle has a frontal collision.



- When driving through a narrow iron bridge.



- When the vehicle ahead of you brakes suddenly.
- When the vehicle ahead of you has a unique shape.

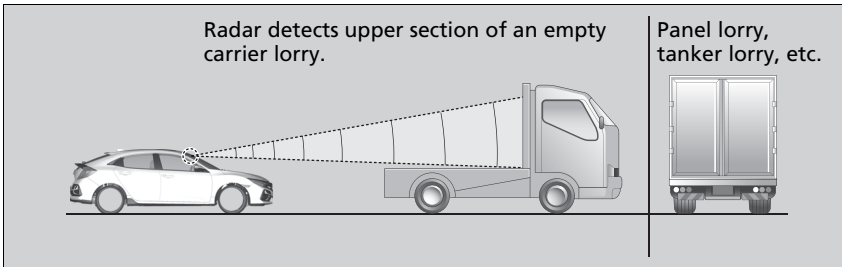

- When your vehicle or the vehicle ahead of you is driving on one edge of the lane.

## ■ To Adjust the Vehicle Speed

Increase or decrease the vehicle speed using the **RES/+** or **-/SET** button on the steering wheel.

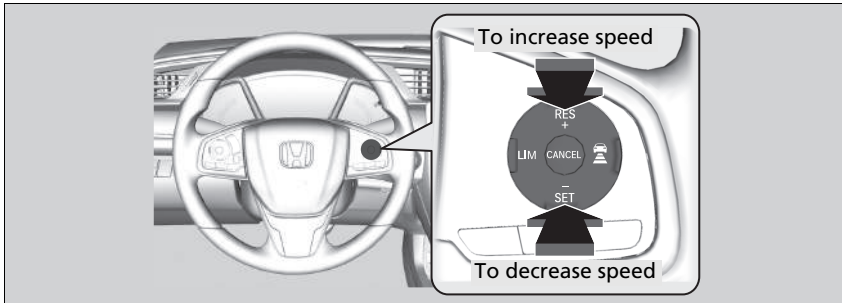

- Each time you press the **RES/+** or **-/SET** button, the vehicle speed is increased or decreased by about 1 km/h or 1 mph accordingly.
- If you keep the **RES/+** or **-/SET** button pressed, the vehicle speed increases or decreases by about 10 km/h or 10 mph accordingly.

## ☒ To Adjust the Vehicle Speed

If a vehicle detected ahead is going at a speed slower than your increased set speed, ACC with Low Speed Follow may not accelerate your vehicle. This is to maintain the set interval between your vehicle and the vehicle ahead.

When you depress the accelerator pedal and then push and release the **-/SET** button, the current speed of the vehicle is set.

## ■ To Set or Change Following-interval

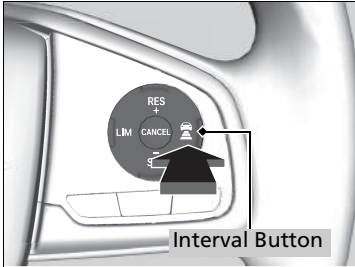





Press the  (interval) button to change the ACC with Low Speed Follow following-interval.

Each time you press the button, the following-interval (the interval behind a vehicle detected ahead of you) setting cycles through extra long, long, middle, and short following-intervals.

Determine the most appropriate following-interval setting based on your specific driving conditions. Be sure to adhere to any following-interval requirements set by local regulation.

The higher your vehicle's following-speed is, the longer the short, middle, long or extra long following-interval becomes. See the following examples for your reference.

Following-interval		When the Set Speed is:	
		80 km/h (50 mph)	104 km/h (65 mph)
Short		25 metres 82 feet 1.1 sec	31.5 metres 103 feet 1.1 sec
Middle		33 metres 108 feet 1.5 sec	43.4 metres 142 feet 1.5 sec
Long		47 metres 154 feet 2.1 sec	60.8 metres 199 feet 2.1 sec
Extra Long		63.5 metres 208.3 feet 2.9 sec	83.4 metres 273.6 feet 2.9 sec

When your vehicle stops automatically because a vehicle detected ahead of you has stopped, the interval between the two vehicles will vary based on the ACC with Low Speed Follow interval setting.

☒ To Set or Change Following-interval

The driver must in all circumstances preserve a sufficient braking interval from the vehicle which precedes it and be aware that minimum intervals or times of spacing can be provided by the provisions of the Motorway Code locally applicable and that it is the driver's responsibility to respect those laws.

## ■ To Cancel

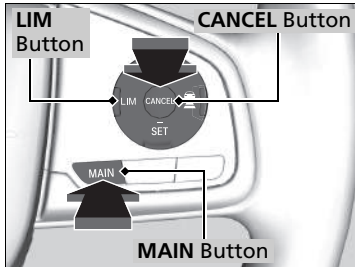

To cancel ACC with Low Speed Follow, do any of the following:

- Press the **CANCEL** button.
- Press the **MAIN** button.
  - ▶ **ACC** with Low Speed Follow indicator goes off.
- Press the **LIM** button.
- Depress the brake pedal while the vehicle is moving forward.

## ▣ To Cancel

Resuming the prior set speed: After you have cancelled ACC with Low Speed Follow, you can resume the prior set speed while it is still displayed. Press the **RES/+** button.

The set speed cannot be set or resumed when ACC with Low Speed Follow has been turned off using the **MAIN** button. Press the **MAIN** button to activate the system, then set the desired speed.

Continued

### ■ Automatic cancellation

The beeper sounds and a message appears on the driver information interface when ACC with Low Speed Follow is automatically cancelled. Any of these conditions may cause the ACC with Low Speed Follow to automatically cancel:

- Bad weather (rain, fog, snow, etc.)
- When the radar sensor in the lower bumper gets dirty.
- The vehicle ahead of you cannot be detected.
- An abnormal tyre condition is detected, or the tyres are skidding.
- Driving on a mountainous road, or driving off road for extended periods.
- Abrupt steering wheel movement.
- When the ABS, VSA or CMBS is activated.
- When the ABS or VSA system indicator comes on.
- When the vehicle is stopped on a very steep slope.
- When you manually apply the parking brake.
- When the detected vehicle within the ACC with Low Speed Follow range is too close to your vehicle.
- The camera behind the rearview mirror, or the area around the camera, including the windscreen, gets dirty.
- When the Maximum Load Limit is exceeded.
- When passing through an enclosed space, such as tunnel.

The ACC with Low Speed Follow automatic cancellation can be also triggered by the following causes. In these cases, the parking brake will be automatically applied.

- The driver's seat belt is unfastened when the vehicle is stationary.
- The vehicle stops for more than 10 minutes.
- The engine is turned off.

### ☒ Automatic cancellation

Even though ACC with Low Speed Follow has been automatically cancelled, you can still resume the prior set speed. Wait until the condition that caused ACC with Low Speed Follow to cancel improves, then press the **-/SET** button.

## ■ Intelligent Adaptive Cruise Control Function

Provides an early prediction for a cut-in situation. The system detects that a vehicle running in the adjacent slower lane has an intention to cut in front of you and adjusts the speed of your vehicle in advance while ACC with Low Speed Follow is activated.

### ■ How the system works

The radar sensor in the lower bumper detects vehicles ahead of you including those in the adjacent lane, and the camera behind the rearview mirror detects the lane markings.

This system improves ACC with Low Speed Follow's following/tracking property; it adjusts your vehicle speed in advance predicting a situation that a vehicle running in the adjacent slower lane catches up with a slower vehicle ahead of it and changes the lane to cut in front of you early.

When such a cut-in situation is predicted, your vehicle speed decreases a little. When detected, your vehicle speed decreases according to the vehicle cutting in front of you.

As the speed is adjusted by the system, the cut in vehicle icon appears on the driver information interface to indicate that the system is activated.

Left-hand drive type is shown.

Continued

### ■ How the system activates

When a vehicle cuts in front of you is going faster than the vehicle ahead of it, and your vehicle is going faster than the cut-in vehicle (i.e., when you need to slow down), ACC with Low Speed Follow predicts the cutting-in and adjust your vehicle speed.

The system activates when all the following conditions are met:

- When ACC with Low Speed Follow is activated.
- When you are driving on a multi-lane road.
- When your vehicle speed is between about 80 km/h (50 mph) and about 180 km/h (112 mph).
- The vehicle is on a straight or slightly curved road.
- The turn signals are off.
- The brake pedal is not depressed.
- When a vehicle cuts in from a slower lane.

### ■ Intelligent adaptive cruise control on and off

You can turn the system on and off using the driver information interface or audio/information screen\*.

📖 **Customized Features\*** P. 171, 396

### 📖 Intelligent Adaptive Cruise Control Function

When traffic changes from right hand side to left hand side, driving on a road where there is oncoming traffic for some distance automatically switches the lane to be detected from right to left.

Intelligent adaptive cruise control may not activate under the following conditions:

- When the speed difference between the cut-in vehicle and the vehicle ahead of it in the adjacent lane\*<sup>1</sup> is small
- When the speed difference between the cut-in vehicle and your vehicle is small (i.e., when speed adjustment is not required)
- When a vehicle simply cuts in front of your vehicle with no vehicle ahead in the adjacent lane\*<sup>1</sup>
- When a vehicle cuts in from a faster lane\*<sup>1</sup>

\*1: Refers to a right hand lane for right hand traffic, left hand lane for left hand traffic.

\* Not available on all models



Manual transmission models

## Adaptive Cruise Control (ACC)

Helps maintain a constant vehicle speed and a set following-interval behind a vehicle detected ahead of yours, without you having to keep your foot on the brake or the accelerator.

When to use

The camera is located behind the rearview mirror.

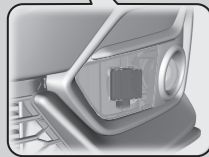
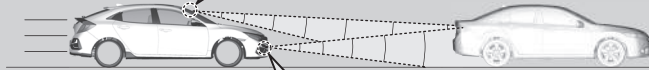
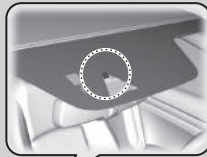

The radar sensor is in the lower bumper.

- Vehicle speed for ACC: Desired speed in a range above roughly 30 km/h (18 mph) ~
- Shift position for ACC: in **2** or higher position

▶ Adaptive Cruise Control (ACC)

### ⚠ WARNING

Improper use of ACC can lead to a crash.

Use ACC only when driving on motorways and in good weather conditions.

### ⚠ WARNING

ACC has limited braking capability. When your vehicle speed drops below 25 km/h (15 mph), ACC will automatically cancel and no longer will apply your vehicle's brakes. Always be prepared to apply the brake pedal when conditions require.

#### Important Reminder

As with any system, there are limits to ACC. Use the brake pedal whenever necessary, and always keep a safe interval between your vehicle and other vehicles.

For directions on the proper handling of the radar sensor, refer to the following page.

➔ **Radar Sensor** P. 632

## ■ How to activate the system

**How to use**

■ Press the **MAIN** button on the steering wheel.

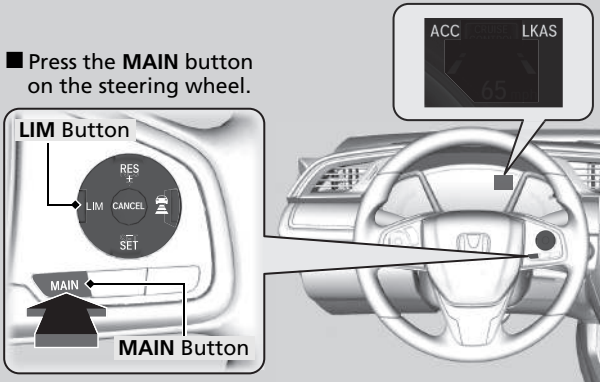

**LIM Button**

**MAIN Button**

**ACC (green) is on in the instrument panel.**  
ACC is ready to use.

If a different instrument panel is displayed, press the **LIM** button to change it to ACC.

## ▣ Adaptive Cruise Control (ACC)

You can read about handling information for the camera equipped with this system.

▣ **Front Sensor Camera** P. 630

The radar sensor for ACC is shared with the Collision Mitigation Braking System (CMBS).

▣ **Collision Mitigation Braking System (CMBS)** P. 565

ACC may not work properly under certain conditions.

▣ **ACC Conditions and Limitations** P. 599

When the engine speed slows down, try to downshift.

When the engine speed goes up, try to upshift.

You can maintain the set speed if you change gear within five seconds.

When not using ACC: Turn off adaptive cruise by pressing the **MAIN** button. This also will turn off the Lane Keeping Assist System (LKAS).

When the **MAIN** button is pressed, both ACC and the Lane Keeping Assist System (LKAS) are either turned on or off.

## ■ To Set the Vehicle Speed

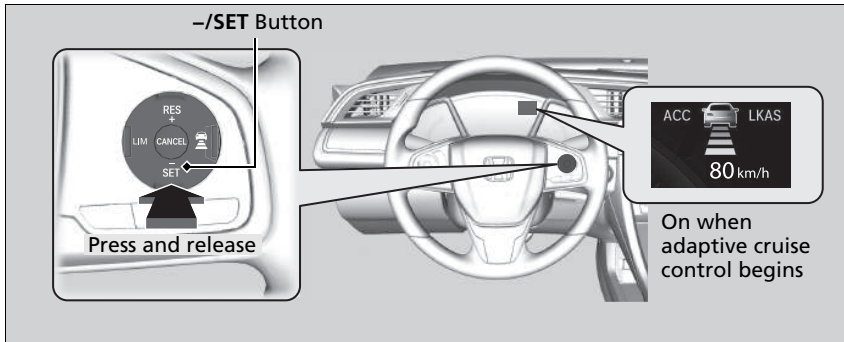

Take your foot off the pedal and press the **-/SET** button when you reach the desired speed.

## ▣ Adaptive Cruise Control (ACC)

Do not use ACC under the following conditions:

- On roads with heavy traffic or while driving in continuous stop and go traffic.
- On roads with sharp turns.
- On roads with steep downhill sections, as the set vehicle speed can be exceeded by coasting. In such cases, ACC will not apply the brakes to maintain the set speed.
- On roads with toll collection facilities or other objects between lanes of traffic, or in parking areas, or facilities with drive through access.

You can switch the displayed set speed measurements on the driver information interface or audio/information screen between mph and km/h.

▶ **Customized Features\*** P. 171, 396

The indicators for the Adaptive Cruise Control (ACC), Road Departure Mitigation, Vehicle Stability Assist (VSA) System, Vehicle Stability Assist (VSA) OFF, Low Tyre Pressure/Deflation Warning System and Collision Mitigation Braking System (CMBS) may come on after reconnecting the battery. Drive a short distance at more than 20 km/h (12 mph). The indicator should go off. If it does not, have your vehicle checked by a dealer.

\* Not available on all models

Continued

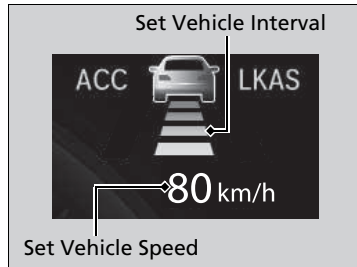

The moment you release the **–/SET** button, the set speed is fixed, and ACC begins.

When ACC starts operating, the vehicle icon, interval bars and set speed appear on the driver information interface.

When you use ACC, Straight Driving Assist (a feature of the Electric Power Steering system) is activated.

By enabling the steering system to automatically compensate for natural steering pull, Straight Driving Assist makes it easier for you to keep your vehicle in a straight line.

#### Adaptive Cruise Control (ACC)

It may take more time to accelerate in ECON mode\*.

You cannot use the ACC and the adjustable speed limiter or intelligent speed limiter\* at the same time.

#### 2.0 L engine models

When you completely disable VSA, you cannot use ACC.

## ■ When in Operation

### ■ There is a vehicle ahead

ACC monitors if a vehicle ahead of you enters the ACC range. If a vehicle is detected doing so, the ACC system maintains or decelerates your vehicle's set speed in order to keep the vehicle's set following-interval from the vehicle ahead.

➤ **To Set or Change Following-interval** P. 603

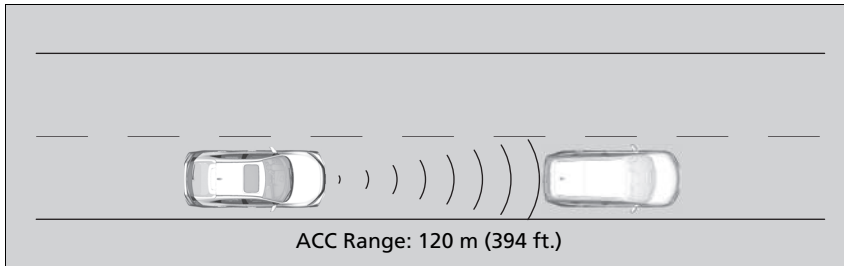

A vehicle icon appears on the driver information interface

When a vehicle whose speed is slower than your set speed comes in or cuts in front of you and is detected by the radar and the camera, your vehicle starts to slow down.

## ▣ When in Operation

If the vehicle ahead of you slows down abruptly, or if another vehicle cuts in front of you, the beeper sounds, a message appears on the driver information interface.

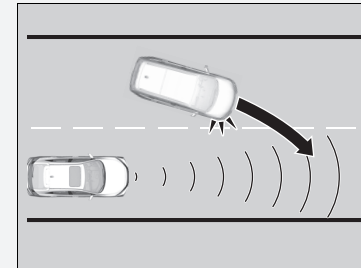

Depress the brake pedal, and keep an appropriate interval from the vehicle ahead.

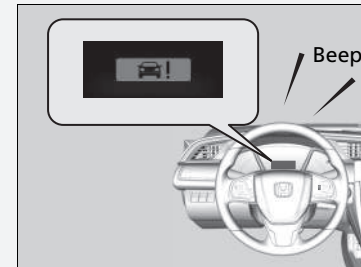

### ■ There is no vehicle ahead

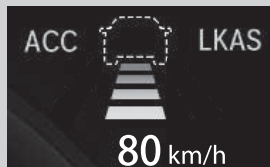

A vehicle icon with dotted-line contour appears on the driver information interface

### ■ When you depress the accelerator pedal

You can temporarily increase the vehicle speed. In this case, there is no audible or visual alert even if a vehicle is in the ACC range. ACC stays on unless you cancel it. Once you release the accelerator pedal, the system resumes an appropriate speed for keeping the following-interval while a vehicle ahead is within the ACC range.

Your vehicle maintains the set speed without having to keep your foot on the brake or accelerator pedal.

If there previously was a vehicle detected ahead that kept your vehicle from travelling at the set speed, ACC accelerates your vehicle to the set speed, and then maintains it.

### ☒ When in Operation

Even if the interval between your vehicle and the vehicle detected ahead is short, ACC may start accelerating your vehicle under the following circumstances:

- The vehicle ahead of you is going at almost the same speed as, or faster than, your vehicle.
- A vehicle that cuts in front of you is going faster than your vehicle, gradually increasing the interval between the vehicles.

You can also set the system to beep when a vehicle detected in front of you comes in and goes out of the ACC detecting range. Change the **ACC Vehicle Ahead Detected Beep** setting.

☒ **Customized Features\*** P. 171, 396

### Limitations

You may need to use the brake to maintain a safe interval when using ACC. Additionally, ACC may not work properly under certain conditions.

☒ **ACC Conditions and Limitations** P. 599

## ■ ACC Conditions and Limitations

The system may automatically shut off and the **ACC** indicator will come on under certain conditions. Some examples of these conditions are listed below. Other conditions may reduce some of the ACC functions.

➤ **Front Sensor Camera** P. 630

### ■ Environmental conditions

Driving in bad weather (rain, fog, snow, etc.).

### ■ Roadway conditions

Driving on a snowy or wet roadway (obscured lane marking, vehicle tracks, reflected lights, road spray, high contrast).

### ■ Vehicle conditions

- The outside of the windscreen is blocked by dirt, mud, leaves, wet snow, etc.
- An abnormal tyre or wheel condition (Wrong sized, varied size or construction, improperly inflated, compact spare tyre\*, etc.).
- The camera temperature gets too high.
- The parking brake is applied.
- When the lower bumper is dirty.
- The vehicle is tilted due to a heavy load or suspension modifications.
- When tyre chains\* are installed.

\* Not available on all models

## ▣ ACC Conditions and Limitations

If you need the radar sensor to be repaired, or removed, or the radar sensor cover is strongly impacted, turn off the system by pressing the **MAIN** button and take your vehicle to a dealer.

### ■ Detection limitations

- A vehicle suddenly crosses in front of you.
- The interval between your vehicle and the vehicle ahead of you is too short.
- A vehicle cuts in front of you at a slow speed, and it brakes suddenly.
- When you accelerate rapidly and approach the vehicle ahead of you at high speed.
- The vehicle ahead of you is a motorcycle, bicycle, mobility scooter, or other small vehicle.
- When there are animals in front of your vehicle.
- When you drive on a curved or winding or undulating road that makes it difficult for the sensor to properly detect a vehicle in front of you.

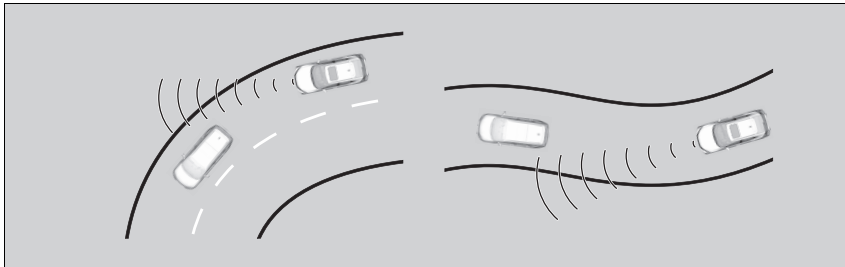

- The speed difference between your vehicle and a vehicle in front of you is significantly large.
- An oncoming vehicle suddenly comes in front of you.
- Your vehicle abruptly crosses over in front of an oncoming vehicle.

### ☒ ACC Conditions and Limitations

Have your vehicle checked by a dealer if you find any unusual behavior of the system (e.g., the warning message appears too frequently).

If the front of the vehicle is impacted in any of the following situations, the radar sensor may not work properly. Have your vehicle checked by a dealer:

- The vehicle mounted onto bump, curb, chock, embankment, etc.
- You drive the vehicle where the water is deep.
- Your vehicle has a frontal collision.



- When driving through a narrow iron bridge.



- When the vehicle ahead of you brakes suddenly.
- When the vehicle ahead of you has a unique shape.

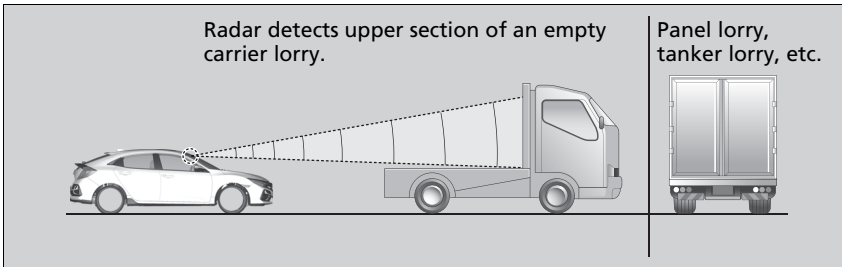

- When your vehicle or the vehicle ahead of you is driving on one edge of the lane.

## ■ To Adjust the Vehicle Speed

Increase or decrease the vehicle speed using the **RES/+** or **-/SET** button on the steering wheel.

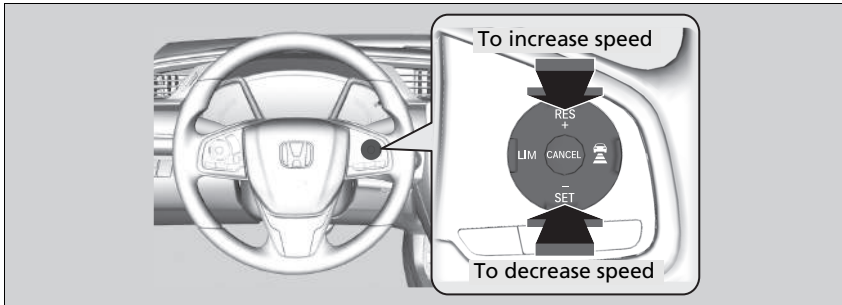

- Each time you press the **RES/+** or **-/SET** button, the vehicle speed is increased or decreased by about 1 km/h or 1 mph accordingly.
- If you keep the **RES/+** or **-/SET** button pressed, the vehicle speed increases or decreases by about 10 km/h or 10 mph accordingly.

## ☒ To Adjust the Vehicle Speed

If a vehicle detected ahead is going at a speed slower than your increased set speed, ACC may not accelerate your vehicle. This is to maintain the set interval between your vehicle and the vehicle ahead.

When you depress the accelerator pedal and then push and release the **-/SET** button, the current speed of the vehicle is set.

## ■ To Set or Change Following-interval

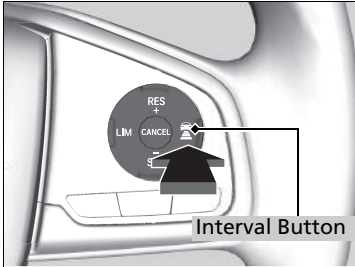



Press the  (interval) button to change ACC following-interval.

Each time you press the button, the following-interval (the interval behind a vehicle detected ahead of you) setting cycles through extra long, long, middle, and short following-intervals.

Determine the most appropriate following-interval setting based on your specific driving conditions. Be sure to adhere to any following-interval requirements set by local regulation.

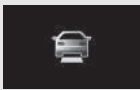
The higher your vehicle's following-speed is, the longer the short, middle, long or extra long following-interval becomes. See the following examples for your reference.

Following-interval		When the Set Speed is:	
		80 km/h (50 mph)	104 km/h (65 mph)
Short		25 metres 82 feet 1.1 sec	31.5 metres 103 feet 1.1 sec
Middle		33 metres 108 feet 1.5 sec	43.4 metres 142 feet 1.5 sec
Long		47 metres 154 feet 2.1 sec	60.8 metres 199 feet 2.1 sec
Extra Long		62 metres 203 feet 2.8 sec	81.4 metres 267 feet 2.8 sec

☒ To Set or Change Following-interval

The driver must in all circumstances preserve a sufficient braking interval from the vehicle which precedes it and be aware that minimum intervals or times of spacing can be provided by the provisions of the Motorway Code locally applicable and that it is the driver's responsibility to respect those laws.

## ■ To Cancel

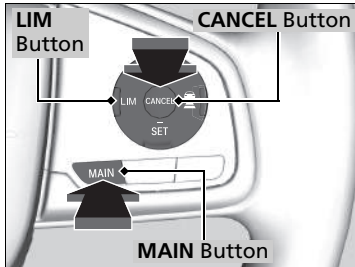

To cancel ACC, do any of the following:

- Press the **CANCEL** button.
- Press the **MAIN** button.
- ▶ **ACC** indicator goes off.
- Press the **LIM** button.
- Depress the brake pedal.
- Depress the clutch pedal for five seconds or more.

## ▣ To Cancel

Resuming the prior set speed: After you have cancelled ACC, you can resume the prior set speed while it is still displayed. Press the **RES/+** button when driving at a speed of at least 30 km/h (18 mph) or more.

The set speed cannot be set or resumed when ACC has been turned off using the **MAIN** button. Press the **MAIN** button to activate the system, then set the desired speed.

Continued

### ■ Automatic cancellation

The beeper sounds and a message appears on the driver information interface when ACC is automatically cancelled. Any of these conditions may cause the ACC is automatically cancelled.

- Bad weather (rain, fog, snow, etc.)
- When the radar sensor in the lower bumper gets dirty.
- The vehicle ahead of you cannot be detected.
- An abnormal tyre condition is detected, or the tyres are skidding.
- Driving on a mountainous road, or driving off road for extended periods.
- Abrupt steering wheel movement.
- When the ABS, VSA or CMBS is activated.
- When the ABS or VSA system indicator comes on.
- When you manually apply the parking brake.
- When the detected vehicle within the ACC range is too close to your vehicle.
- The camera behind the rearview mirror, or the area around the camera, including the windscreen, gets dirty.
- When the Maximum Load Limit is exceeded.
- When passing through an enclosed space, such as tunnel.
- Ignoring shift down indication shown in the tachometer display will cancel the ACC after about 10 seconds.
- The engine speed goes into the tachometer's red zone.
- The engine speed goes to below 1,000 rpm.
- You shift into neutral temporarily when shifting into a higher or lower gear.

### ⌘ Automatic cancellation

Even though ACC has been automatically cancelled, you can still resume the prior set speed. Wait until the condition that caused ACC to cancel improves, then press the **-/SET** button.

### 2.0 L engine models

If you completely disable VSA while ACC is activated, ACC will automatically be cancelled.

## ■ Intelligent Adaptive Cruise Control Function

Provides an early prediction for a cut-in situation. The system detects that a vehicle running in the adjacent slower lane has an intention to cut in front of you and adjusts the speed of your vehicle in advance while ACC is activated.

### ■ How the system works

The radar sensor in the lower bumper detects vehicles ahead of you including those in the adjacent lane, and the camera behind the rearview mirror detects the lane markings.

This system improves ACC's following/tracking property; it adjusts your vehicle speed in advance predicting a situation that a vehicle running in the adjacent slower lane catches up with a slower vehicle ahead of it and changes the lane to cut in front of you early.

When such a cut-in situation is predicted, your vehicle speed decreases a little. When detected, your vehicle speed decreases according to the vehicle cutting in front of you.

As the speed is adjusted by the system, the cut in vehicle icon appears on the driver information interface to indicate that the system is activated.

Left-hand drive type is shown.

Continued

### ■ How the system activates

When a vehicle cuts in front of you is going faster than the vehicle ahead of it, and your vehicle is going faster than the cut-in vehicle (i.e., when you need to slow down), ACC predicts the cutting-in and adjust your vehicle speed.

The system activates when all the following conditions are met:

- When ACC is activated.
- When you are driving on a multi-lane road.
- When your vehicle speed is between about 80 km/h (50 mph) and about 180 km/h (112 mph).
- The vehicle is on a straight or slightly curved road.
- The turn signals are off.
- The brake pedal is not depressed.
- When a vehicle cuts in from a slower lane.

### ■ Intelligent adaptive cruise control on and off

You can turn the system on and off using the driver information interface or audio/information screen\*.

📖 **Customized Features\*** P. 171, 396

### 📖 Intelligent Adaptive Cruise Control Function

When traffic changes from right hand side to left hand side, driving on a road where there is oncoming traffic for some distance automatically switches the lane to be detected from right to left.

Intelligent adaptive cruise control may not activate under the following conditions:

- When the speed difference between the cut-in vehicle and the vehicle ahead of it in the adjacent lane\*<sup>1</sup> is small
- When the speed difference between the cut-in vehicle and your vehicle is small (i.e., when speed adjustment is not required)
- When a vehicle simply cuts in front of your vehicle with no vehicle ahead in the adjacent lane\*<sup>1</sup>
- When a vehicle cuts in from a faster lane\*<sup>1</sup>

\*1: Refers to a right hand lane for right hand traffic, left hand lane for left hand traffic.

\* Not available on all models



## Lane Keeping Assist System (LKAS)

Provides steering input to help to keep the vehicle in the middle of a detected lane and provides tactile, audible and visual alerts if the vehicle is detected drifting out of its lane.

### ■ Steering input assist

The system applies torque to the steering to keep the vehicle between the left and right lane lines. The applied torque becomes stronger as the vehicle gets closer to either of the lane lines.



■ Front Sensor Camera  
Monitors the lane lines

■ Tactile, audible and visual alerts  
Rapid vibrations on the steering wheel, audible and a warning display alert you that the vehicle is drifting out of a detected lane.

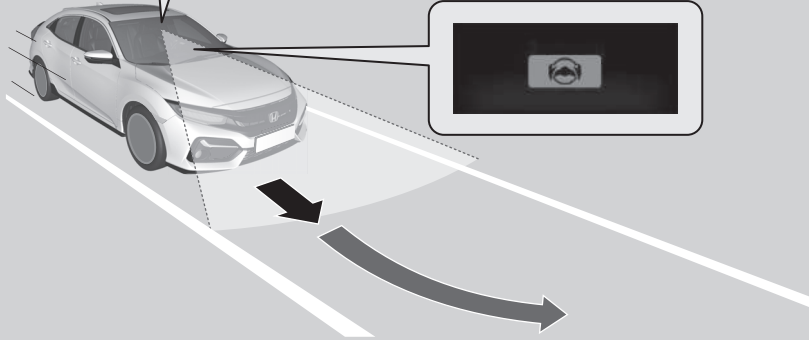

When you operate the turn signals to change lanes, the system is suspended, and resumes after the signals are off.  
If you make a lane change without operating the turn signals, the LKAS alerts activate, and torque is applied to the steering.

### ▣ Lane Keeping Assist System (LKAS)

#### Important Safety Reminders

The LKAS is for your convenience only. It is not a substitute for your vehicle control. The system does not work if you take your hands off the steering wheel or fail to steer the vehicle.

#### ▣ Driver Information Interface Warning and Information Messages P. 135

Do not place objects on the instrument panel. Objects may reflect on the windscreen and prevent correct detection of the traffic lanes.

The LKAS only alerts you when lane drift is detected without a turn signal in use. The LKAS may not detect all lane markings or lane departures; accuracy will vary based on weather, speed, and lane marker condition.

It is always your responsibility to safely operate the vehicle and avoid collisions.

The LKAS is convenient when it is used on motorways or a dual carriage way.

The LKAS may not work properly or may work improperly under the certain conditions:

#### ▣ LKAS Conditions and Limitations P. 614

You can read about handling information for the camera equipped with this system.

#### ▣ Front Sensor Camera P. 630

### ■ Lane Keep Support Function

Provides assistance to keep the vehicle in the centre of the lane. When the vehicle nears a white or yellow line, steering force of the electric power steering will become stronger.

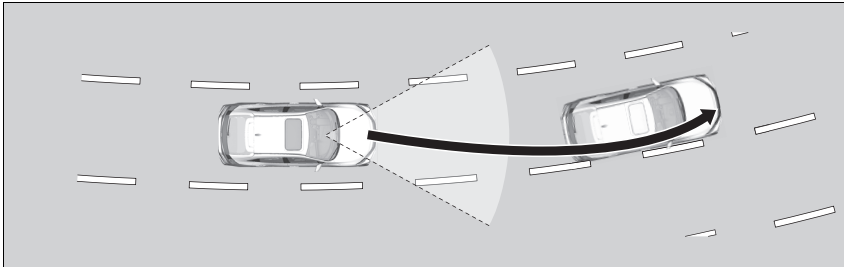

### ■ Lane Departure Warning Function

When the vehicle enters the warning area, the LKAS alerts you with slight steering wheel vibration, and audible and visual warnings.

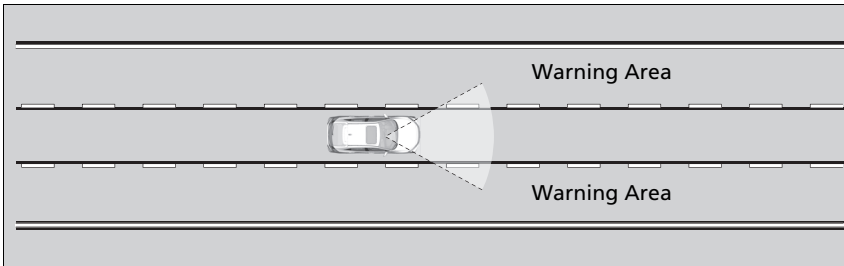

### ☒ Lane Keeping Assist System (LKAS)

The LKAS may not function as designed while driving in frequent stop and go traffic, or on roads with sharp curves.

When it fails to detect lanes, the system will temporarily be cancelled. When a lane is detected, the system will recover automatically.

## ■ When the System can be Used

The system can be used when the following conditions are met.

- The lane in which you are driving has detectable lane markers on both sides, and your vehicle is in the centre of the lane.
- The vehicle is travelling between about 72 and 185 km/h (45 and 115 mph).
- You are driving on a straight or slightly curved road.
- The turn signals are off.
- The brake pedal is not depressed.
- The wipers are not in continuous operation.

## ■ How to activate the system

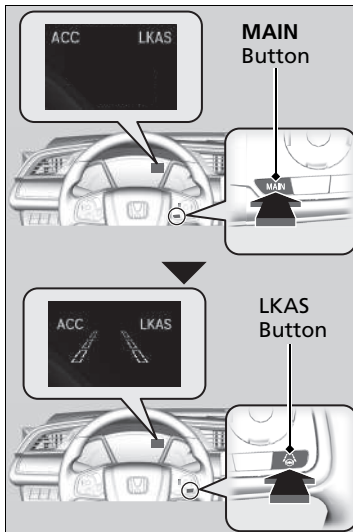

1. Press the **MAIN** button.
  - ▶ The LKAS is on in the driver information interface.  
The system is ready to use.
2. Press the LKAS button.
  - ▶ Lane outlines appear on the driver information interface.  
The system is activated.

## ▣ When the System can be Used

If the vehicle drifts toward either left or right lane line due to the system applying torque, turn off the LKAS and have your vehicle checked by a dealer.

### 2.0 L engine models

When you completely disable VSA, you cannot use LKAS.

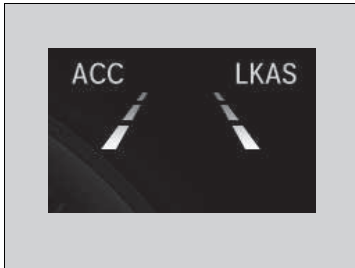

3. Keep your vehicle near the centre of the lane while driving.
  - ▶ The dotted outer lines change to solid ones once the system starts operating after detecting the left and right lane markings.

### To Cancel

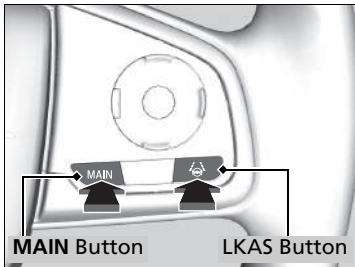

To cancel the LKAS:  
Press the **MAIN** or LKAS button.

The LKAS is turned off every time you stop the engine, even if you turned it on the last time you drove the vehicle.

### ⌕ To Cancel

#### Models with ACC with Low Speed Follow

Pressing the **MAIN** button also turns ACC with Low Speed Follow on and off.

#### Models with ACC

Pressing the **MAIN** button also turns ACC on and off.

#### 2.0 L engine models

If you completely disable VSA while LKAS is activated, LKAS will automatically be cancelled.



When the LKAS is suspended, the lane lines on the driver information interface change to contour lines, and the beeper sounds (if activated).

■ **The system operation is suspended if you:**

- Set the wipers to continuous operation.
  - ▶ Turning the wipers off resumes the LKAS.

Models with automatic intermittent wipers

- Set the wiper switch to **AUTO** the wipers operate continuously.
  - ▶ The LKAS resumes when the wipers stop or operate intermittently.

All models

- Decrease the vehicle speed to 64 km/h (40 mph) or less.
  - ▶ Increasing the vehicle speed to 72 km/h (45 mph) or more resumes the LKAS.
- Depress the brake pedal.
  - ▶ The LKAS resumes and starts detecting the lane lines again once you release the brake pedal.

■ **The LKAS may automatically be suspended when:**

- The system fails to detect lane lines.
- The steering wheel is quickly turned.
- You fail to steer the vehicle.
- Driving through a sharp curve.
- Driving at a speed in excess of approximately 185 km/h (115 mph).
- The Road Departure Mitigation System is activated.

Once these conditions no longer exist, the LKAS automatically resumes.

■ **The LKAS may automatically be cancelled when:**

- The camera temperature gets extremely high or low.
- The camera behind the rearview mirror, or the area around the camera, including the windscreen, gets dirty.
- The ABS or VSA system engages.

The beeper sounds if the LKAS is automatically cancelled.

■ **LKAS Conditions and Limitations**

The system may not detect lane markings and therefore may not keep the vehicle in the middle of a lane under certain conditions, including the following:

■ **Environmental conditions**

- Driving in bad weather (rain, fog, snow, etc.).
- Sudden changes between light and dark, such as an entrance or exit of a tunnel.
- There is little contrast between lane lines and the roadway surface.
- Driving into low sunlight (e.g., at dawn or dusk).
- Strong light is reflected onto the roadway.
- Driving in the shadows of trees, buildings, etc.
- Shadows of adjacent objects are parallel to lane markings.
- Roadway objects or structures are misinterpreted as lane markers.
- Reflections on the interior of the windscreen.
- Driving at night or in a dark condition such as a tunnel.

■ **Roadway conditions**

- Driving on a snowy or wet roadway (obscured lane marking, vehicle tracks, reflected lights, road spray, high contrast).
- Driving on a road with temporary lane markings.
- Faint, multiple, or varied lane markings are visible on the roadway due to road repairs or old lane markings.

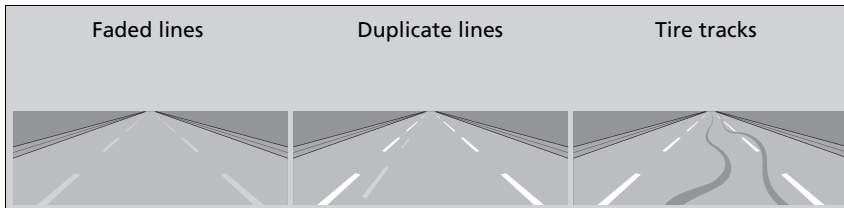

- The roadway has merging, split, or crossing lines (e.g., such as at an intersection or crosswalk).
- The lane markings are extremely narrow, wide, or changing.

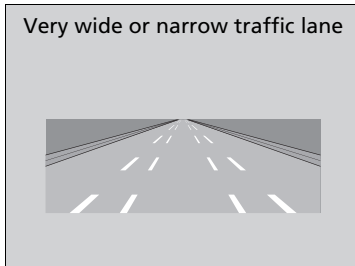

- The vehicle in front of you is driving near the lane lines.
- The road is hilly or the vehicle is approaching the crest of a hill.
- Driving on rough or unpaved roads, or over bumpy surfaces.

- When objects on the road (curb, guard rail, pylons, etc.) are recognised as white lines (or yellow lines).
- Driving on roads with double lines.

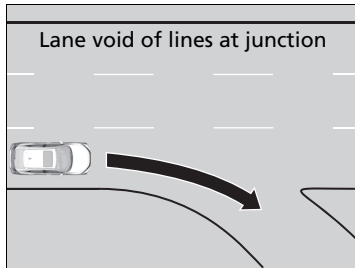

#### ■ Vehicle conditions

- Headlight lenses are dirty or the headlights are not properly adjusted.
- The outside of the windscreen is streaked or blocked by dirt, mud, leaves, wet snow, etc.
- The inside of the windscreen is fogged.
- The camera temperature gets too high.
- An abnormal tyre or wheel condition (wrong sized, varied size or construction, improperly inflated, compact spare tyre\*, etc.).
- The vehicle is tilted due to a heavy load or suspension modifications.

#### 1.0 L engine models with climate control system

- The vehicle is towing a trailer.



## Road Departure Mitigation System

Alerts and helps to assist you when the system detects a possibility of your vehicle unintentionally crossing over detected lane markings or the edge of the pavement, or leaving the roadway altogether.

### ■ How the System Works

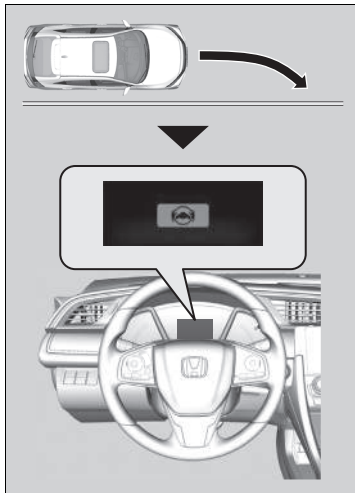

The front camera behind the rearview mirror monitors left and right lane markings (in white or yellow) and the outer edge of the pavement (bordered by grass or gravel). If your vehicle is getting too close to detected lane markings or the outer edge of the pavement (bordered by grass or gravel) without a turn signal activated, the system, in addition to a visual alert, applies steering torque and alerts you with rapid vibrations on the steering wheel, to help you remain within the detected lane.

If the system determines that the vehicle is about to veer off the edge of the pavement, it will alert the driver with an audible warning instead of steering wheel vibrations.

▶ **Customized Features\*** P. 171, 396

As a visual alert,  appears on the driver information interface.

If the system determines that its steering input is insufficient to keep your vehicle on the roadway, it may apply braking.

▶ Braking is applied only when the lane markings are solid continuous lines.

\* Not available on all models

### ▶▶ Road Departure Mitigation System

#### ▶▶ Important Safety Reminder

Like all assistance systems, the Road Departure Mitigation system has limitations.

Over-reliance on the Road Departure Mitigation system may result in a collision. It is always your responsibility to keep the vehicle within your driving lane.

The Road Departure Mitigation system only alerts you when lane drift is detected without a turn signal in use. The Road Departure Mitigation system may not detect all lane markings or lane or roadway departures; accuracy will vary based on weather, speed and lane marker condition. It is always your responsibility to safely operate the vehicle and avoid collisions.

You can read about handling information for the camera equipped with this system.

▶▶ **Front Sensor Camera** P. 630

The Road Departure Mitigation system may not work properly or may work improperly under the certain conditions:

▶▶ **Road Departure Mitigation Conditions and Limitations** P. 621

Continued

The system cancels assisting operations when you turn the steering wheel to avoid crossing over detected lane markings.

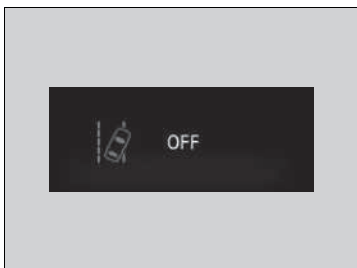

If the system operates several times without detecting driver response, the system beeps to alert you. After that, the Road Departure Mitigation steering assist is temporarily stopped, and the warning sound is given only.



After a few minutes, the message to the left is displayed and the Road Departure Mitigation system is fully restored.

#### ▣ Road Departure Mitigation System

If LKAS is off and you have selected **Early** from the customised options using the driver information interface or audio/information screen\*, the message below will appear if the system has determined that there is a possibility of your vehicle crossing over detected lane markings or the outer edge of the pavement (into grass or gravel border). If you have selected **Normal**, **Delayed**, or **Warning Only**, however, the message will only appear if the vehicle is about to cross over the outer edge of the pavement.

▣ **Customized Features\*** P. 171, 396

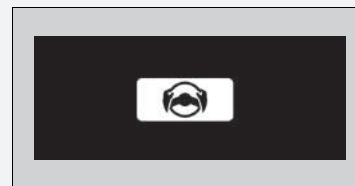

#### 2.0 L engine models

The Road Departure Mitigation System does not function while VSA is completely disabled.

## ■ How the System Activates

The system becomes ready to start searching for lane markings when all the following conditions are met:

- The vehicle is travelling between about 72 and 185 km/h (45 and 115 mph).
- The vehicle is on a straight or slightly curved road.
- The turn signals are off.
- The brake pedal is not depressed.
- The wipers are not in continuous operation.
- The vehicle is not accelerating or braking, and the steering wheel is not being turned.
- The system makes a determination that the driver is not actively accelerating, braking or steering.

## ▣ How the System Activates

The Road Departure Mitigation system may automatically shut off and the  indicator comes and stays on.

▶ **Indicators** P. 108

Road Departure Mitigation system function can be impacted when the vehicle is:

- Not driven within a traffic lane.
- Driven on the inside edge of a curve, or outside of a lane.
- Driven in a narrow lane.

*Continued*

## Road Departure Mitigation On and Off

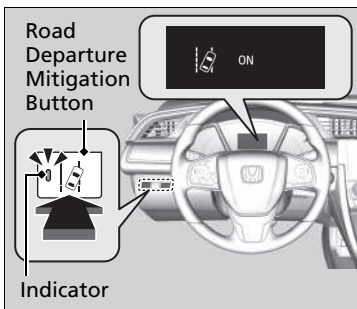

Press the Road Departure Mitigation button to turn the system on and off.

- ▶ The indicator in the button comes on and the message appears on the driver information interface when the system is on.

## ▣ Road Departure Mitigation On and Off

When you have selected **Warning Only** from the customized options using the driver information interface or audio/information screen\* the system does not operate the steering wheel and braking.

▣ **Customized Features\*** P. 171, 396

The indicators for the Adaptive Cruise Control (ACC)\*, Adaptive Cruise Control (ACC) with Low Speed Follow\*, Road Departure Mitigation, Vehicle Stability Assist (VSA) System, Vehicle Stability Assist (VSA) OFF, Low Tyre Pressure/Deflation Warning System and Collision Mitigation Braking System (CMBS) may come on after reconnecting the battery. Drive a short distance at more than 20 km/h (12 mph). The indicator should go off. If it does not, have your vehicle checked by a dealer.

## ■ Road Departure Mitigation Conditions and Limitations

The system may not properly detect lane markings and the position of your vehicle under certain conditions. Some examples of these conditions are listed below.

### ■ Environmental conditions

- Driving in bad weather (rain, fog, snow, etc.).
- Sudden changes between light and dark, such as an entrance or exit of a tunnel.
- There is little contrast between lane lines and the roadway surface.
- Driving into low sunlight (e.g., at dawn or dusk).
- Strong light is reflected onto the roadway.
- Driving in the shadows of trees, buildings, etc.
- Shadows of adjacent objects are parallel to lane markings.
- Roadway objects or structures are misinterpreted as lane markers.
- Reflections on the interior of the windscreen.
- Driving at night or in a dark condition such as a tunnel.
- The outer edge of the pavement is bordered by objects, material etc. other than grass or gravel.

### ■ Roadway conditions

- Driving on a snowy or wet roadway (obscured lane marking, vehicle tracks, reflected lights, road spray, high contrast).
- Driving on a road with temporary lane markings.
- Faint, multiple, or varied lane markings are visible on the roadway due to road repairs or old lane markings.
- The roadway has merging, split, or crossing lines (e.g., such as at an intersection or crosswalk).
- The lane markings are extremely narrow, wide, or changing.
- The vehicle in front of you is driving near the lane lines.
- The road is hilly or the vehicle is approaching the crest of a hill.
- Driving on rough or unpaved roads, or over bumpy surfaces.
- When objects on the road (curb, guard rail, pylons, etc.) are recognised as white lines (or yellow lines).
- Driving on roads with double lines.

### ■ Vehicle conditions

- Headlight lenses are dirty or the headlights are not properly adjusted.
- The outside of the windscreen is streaked or blocked by dirt, mud, leaves, wet snow, etc.
- The inside of the windscreen is fogged.
- The camera temperature gets too high.
- An abnormal tyre or wheel condition (wrong sized, varied size or construction, improperly inflated, compact spare tyre\*, etc.).
- The vehicle is tilted due to a heavy load or suspension modifications.
- When tyre chains\* are installed.

#### 1.0 L engine models with climate control system

- The vehicle is towing a trailer.

## Traffic Sign Recognition System

Reminds you of road sign information, such as the current speed limit and that overtaking is prohibited, your vehicle has just passed through, showing it on the driver information interface.

### ■ How the System Works

When the camera located behind the rearview mirror captures traffic signs while driving, the system displays the ones that are recognised as designated for your vehicle. The sign icon will be displayed until the vehicle reaches a predetermined time and distance.

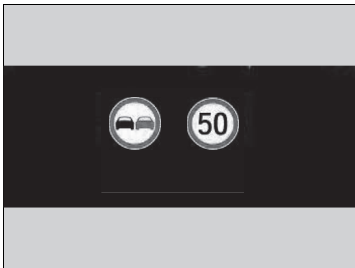

The sign icon also may switch to another one, or disappear when:

- The end of speed limit or other designated limit is detected.
- Your vehicle enters/exits motorway or highway.
- You make a turn with a turn signal at an intersection.

### ▣ Traffic Sign Recognition System

The system is designed to detect signs that follow the Vienna Convention standards. Not all signs may be displayed, but any signs posted on roadsides should not be ignored. The system does not work on the designated traffic signs of all the countries you travel, nor in all situations.

Do not rely too much on the system. Always drive at speeds appropriate for the road conditions.

Never apply a film or attach any objects to the windscreen that could obstruct the camera's field of vision and cause the system to operate abnormally. Scratches, nicks, and other damage to the windscreen within the camera's field of vision can cause the system to operate abnormally. If this occurs, we recommend that you replace the windscreen with a genuine Honda replacement windscreen. Making even minor repairs within the camera's field of vision or installing an aftermarket replacement windscreen may also cause the system to operate abnormally. After replacing the windscreen, have a dealer recalibrate the camera. Proper calibration of the camera is necessary for the system to operate properly.

#### 2.0 L engine models

Traffic Sign Recognition System does not function while VSA is completely disabled.

If the system does not detect any traffic signs while you are driving, the image below may appear.

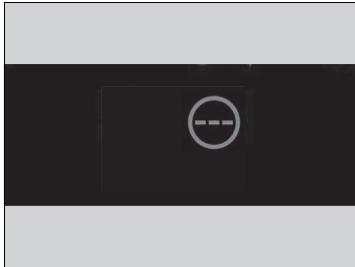

#### ☒ Traffic Sign Recognition System

To help reduce the likelihood that high interior temperatures will cause the camera's sensing system to shut off, when parking, find a shady area or face the front of the vehicle away from the sun. If you use a reflective sun shade, do not allow it to cover the camera housing.

Covering the camera can concentrate heat on it.

You can read about handling information for the camera equipped with this system.

☒ **Front Sensor Camera** P. 630



## ■ Traffic Sign Recognition System Conditions and Limitations

The Traffic Sign Recognition system may not be able to recognise the traffic sign in the following cases.

### ■ Vehicle conditions

- Headlight lenses are dirty or the headlights are not properly adjusted.
- The outside of the windscreen is blocked by dirt, mud, leaves, wet snow, etc.
- The inside of the windscreen is fogged.
- There are portions remaining to be wiped.
- An abnormal tyre or wheel condition (wrong sized, varied size or construction, improperly inflated, compact spare tyre\*, etc.).
- The vehicle is tilted due to a heavy load or suspension modifications.

### ■ Environmental conditions

- Driving into low sunlight (e.g., at dawn or dusk).
- Strong light is reflected onto the roadway.
- Sudden changes between light and dark, such as an entrance or exit of a tunnel.
- When you drive in the shadows of trees, buildings, etc.
- Driving at night, in dark areas such as long tunnels.
- Driving in bad weather (rain, fog, snow, etc.).
- A vehicle in front of you is travelling flying up spray or snow.

\* Not available on all models

## ■ Traffic Sign Recognition System Conditions and Limitations

When the Traffic Sign Recognition System malfunctions,  appears on the driver information interface. If this message does not disappear, have your vehicle checked by a dealer.

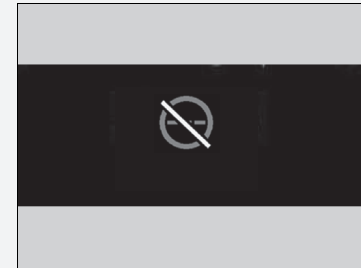

Continued

■ **The position or the condition of the traffic sign**

- A sign is hard to be found since it is in a complicated area.
- A sign is located far away from your vehicle.
- A sign is located where the beam of the headlight is hard to reach.
- A sign is on a corner or bend in the road.
- Faded or bent signs.
- Rotated or damaged signs.
- A sign is covered with mud, snow, or frost.
- A part of the sign is hidden by the trees, or the sign itself is hidden by a vehicle and others.
- Light (a streetlight) or a shadow is reflected on the surface of the sign.
- A sign is too bright or too dark (an electric sign).
- A sign of a small size.

■ **Other conditions**

- When you are driving at a high speed.

The Traffic Sign Recognition System may not operate correctly, such as displaying a sign that does not follow the actual regulation for the roadway or does not exist at all in the following cases.

- ▶ A speed limit sign may display at a higher or lower speed than the actual speed limit.
- There is a supplementary sign with further information such as weather, time, vehicle type, etc.
- Figures on the sign are hard to read (electric signs, numbers on the sign are blurred, etc.).
- A sign is in the vicinity of the lane you are driving even though it is not for the lane (speed limit sign situated at the junction between the side road and the main road, etc.).
- There are things that look similar to the colour or shape of the recognition object (similar sign, electric sign, signboard, structure, etc.).
- A lorry or another large vehicle with a sticker of the speed limit sign on the back are travelling in front of you.

### ■ Signs Displayed on the Driver Information Interface

Two traffic signs can be simultaneously displayed next to each other when detected. The speed limit sign icon is displayed on the right half of the screen. The overtaking prohibition sign icon appears on the left. Any additional sign that indicates speed limit based on weather (rain, snow, etc.) or specific period of time can appear on either side.

#### ■ When main mode is selected



Overtaking Prohibition Sign\*<sup>1</sup>      Speed Limit Sign

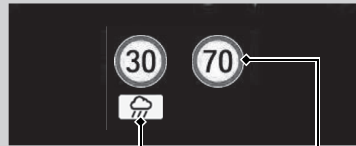

Additional Speed Limit Sign Based on Conditions\*<sup>2</sup>      Speed Limit Sign

#### ■ When main mode is not selected



Speed Limit Sign

Overtaking Prohibition Sign\*<sup>1</sup>

Depending on situation, \*1 can be replaced with \*2, or \*2 can appear on the right side.

■ **Selecting to display traffic signs when main mode is off**

You can continue displaying reduced-size traffic sign icon on the driver information interface even while the main mode is not selected.

➤ **Customized Features\*** P. 171, 396

\* Not available on all models

## Front Sensor Camera

The camera, used in systems such as Lane Keeping Assist System (LKAS), Road Departure Mitigation System, Adaptive Cruise Control (ACC) with Low Speed Follow\*, Adaptive Cruise Control (ACC)\*, Traffic Sign Recognition System, and Collision Mitigation Braking System (CMBS), is designed to detect an object that triggers any of the systems to operate its functions.

### Camera Location and Handling Tips

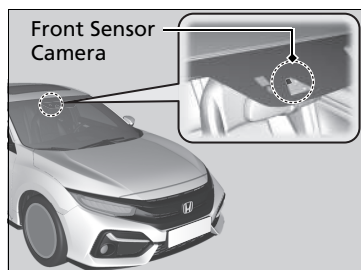

This camera is located behind the rearview mirror.

To help reduce the likelihood that high interior temperatures will cause the camera's sensing system to shut off, when parking, find a shady area or face the front of the vehicle away from the sun. If you use a reflective sun shade, do not allow it to cover the camera housing. Covering the camera can concentrate heat on it.

### Front Sensor Camera

Never apply a film or attach any objects to the windshield, the bonnet, or the front grille that could obstruct the camera's field of vision and cause the system to operate abnormally.

Scratches, nicks, and other damage to the windshield within the camera's field of vision can cause the system to operate abnormally. If this occurs, we recommend that you replace the windshield with a genuine Honda replacement windshield. Making even minor repairs within the camera's field of vision or installing an aftermarket replacement windshield may also cause the system to operate abnormally.

After replacing the windshield, have a dealer recalibrate the camera. Proper calibration of the camera is necessary for the system to operate properly.

Do not place an object on the top of the instrument panel. It may reflect onto the windshield and prevent the system from detecting lane lines properly.

▣ Front Sensor Camera

If the  message appears:

- Use the climate control system to cool down the interior and, if necessary, also use demister mode with the airflow directed towards the camera.
- Start driving the vehicle to lower the windscreen temperature, which cools down the area around the camera.

If the  message appears:

- Park your vehicle in a safe place, and clean the windscreen. If the message does not disappear after you have cleaned the windscreen and driven for a while, have your vehicle checked by a dealer.

## Radar Sensor

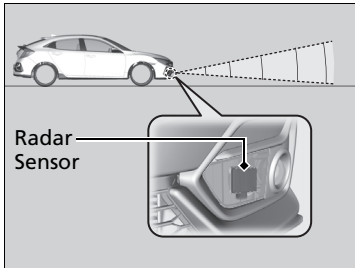

The radar sensor is at the lower part of the front bumper.

### ☒ Radar Sensor

Avoid strong impacts to the radar sensor cover.

For the CMBS to work properly:

- Always keep the radar sensor cover clean.
- Never use chemical solvents or polishing powder for cleaning the sensor cover. Clean it with water or a mild detergent.
- Do not put a sticker on the radar sensor cover or replace the radar sensor cover.

If you need the radar sensor to be repaired, or removed, or the radar sensor cover is strongly impacted, turn off the system by using the CMBS **OFF** button and take your vehicle to a dealer.

☒ **CMBS On and Off** P. 569

If the vehicle is involved in any of the following situations, the radar sensor may not work properly.

Have your vehicle checked by a dealer:

- Your vehicle is involved in a frontal collision.
- Your vehicle drives through deep water or is submerged in deep water.
- Your vehicle strongly strikes a bump, curb, chock, or embankment that could jar the radar sensor.



## Brake System

### ■ Parking Brake

Use the parking brake to keep the vehicle stationary when parked. When the parking brake is applied, you can manually or automatically release it.



Electric Parking Brake Switch



Electric Parking Brake Switch

#### ■ To apply

The electric parking brake can be applied any time the vehicle has battery, no matter which position the ignition switch\*1 is in.

Pull the electric parking brake switch up gently and securely.

- ▶ The parking brake and brake system indicator (red) comes on.

#### ■ To release

The vehicle must be ON \*1 in order to release the electric parking brake.

1. Depress the brake pedal.
2. Press the electric parking brake switch.
  - ▶ The parking brake and brake system indicator (red) goes off.

Manually releasing the parking brake using the switch helps your vehicle start slowly and smoothly when facing down hill on steep hills.

\*1: Models with the keyless access system have an **ENGINE START/STOP** button instead of an ignition switch.

### ▣ Parking Brake

You may hear the electric parking brake system motor operating from the rear wheel area when you apply or release the parking brake. This is normal.

The brake pedal may slightly move due to the electric parking brake system operation when you apply or release the parking brake. This is normal.

You cannot apply or release the parking brake if the battery goes dead.

▣ **If the Battery Is Dead** P. 772

**If you pull up and hold the electric parking brake switch while driving, the brakes on all four wheels are applied by the VSA system until the vehicle comes to a stop. The electric parking brake then applies, and the switch should be released.**

In the following situations, the parking brake automatically operates.

- When the vehicle stops with the automatic brake hold system activated for more than 10 minutes.
- When the driver's seat belt is unfastened while your vehicle is stopped and automatic brake hold is applied.
- When the engine is turned off, except by Auto Idle Stop system, while automatic brake hold is applied.
- When there is a problem with the Brake Hold System.

### ■ To release automatically

Use the accelerator pedal to release the parking brake when you are starting the vehicle facing uphill, or in a traffic jam.

#### Continuously variable transmission models

Depressing the accelerator pedal releases the parking brake.

#### Manual transmission models

Depress the accelerator pedal while releasing the clutch pedal releases the parking brake.

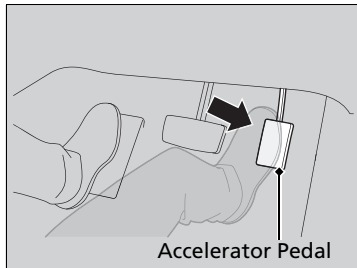

#### Continuously variable transmission models

Gently depress the accelerator pedal.

When on a hill, it may require more accelerator input to release.

- The parking brake and brake system indicator (red) goes off.

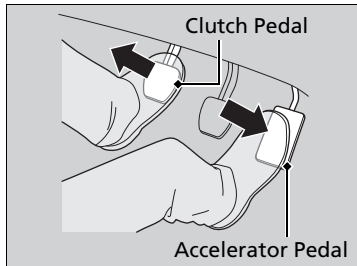

#### Manual transmission models

Gently depress the accelerator pedal and release the clutch pedal.

- The parking brake and brake system indicator (red) goes off.

\* 1: Models with the keyless access system have an **ENGINE START/STOP** button instead of an ignition switch.

### ▣ Parking Brake

#### Models with ACC with Low Speed Follow

- When the vehicle stops more than 10 minutes while ACC with Low Speed Follow is activated.
- When the driver's seat belt is unfastened while your vehicle is stopped automatically by ACC with Low Speed Follow.
- When the engine is turned off, except by Auto Idle Stop system, while ACC with Low Speed Follow is activated.

#### Manual transmission models

- When there is a problem with the electric parking brake switch, after you turn the ignition switch to LOCK **0**\*1.

If the parking brake cannot be released automatically, release it manually.

When the vehicle is travelling uphill, the accelerator pedal may need to be pressed farther to automatically release the electric parking brake.

The parking brake cannot be released automatically while the following indicators are on:

- Malfunction indicator lamp
- Transmission system indicator

The parking brake may not be released automatically while the following indicators are on:

- Brake system indicator
- VSA system indicator
- **ABS** indicator
- Supplemental restraint system indicator

The parking brake automatically releases as you depress the accelerator pedal when:

- You are wearing the driver's seat belt.
- The engine is running.

**Continuously variable transmission models**

- The transmission is not in **P** or **N**.

**Manual transmission models**

- The transmission is not in **N**.

**Foot Brake**

Your vehicle is equipped with disc brakes at all four wheels. A vacuum power assist helps to reduce the effort needed on the brake pedal. The brake assist system increases the stopping force when you depress the brake pedal hard in an emergency situation. The anti-lock brake system (ABS) helps you retain steering control when braking very hard.

➤ **Brake Assist System** P. 640

➤ **Anti-lock Brake System (ABS)** P. 639

**2.0 L engine models**

**Brake squeal**

To satisfy the performance under a wide range of driving conditions, a high-performance braking system is equipped on your vehicle. You may hear the brake squeal under certain conditions, such as vehicle speed, deceleration, humidity, and so on. This is not a malfunction.

►► Parking Brake

**Manual transmission models**

The clutch pedal is fully depressed before gently depress the accelerator pedal and release the clutch pedal.

►► Foot Brake

Check the brakes after driving through deep water, or if there is a buildup of road surface water. If necessary, dry the brakes by lightly depressing the pedal several times.

If you hear a continuous metallic friction sound when applying the brakes, the brake pads need to be replaced. Have your vehicle checked by a dealer.

Constantly using the brake pedal while going down a long hill builds up heat, which reduces the brake effectiveness. Apply engine braking by taking your foot off the accelerator pedal and downshifting to a lower gear/speed position. With manual transmission use a lower gear for greater engine braking.

Do not rest your foot on the brake pedal while driving, as it will lightly apply the brakes and cause them to lose effectiveness over time and reduce pad life. It will also confuse drivers behind you.

## Automatic Brake Hold

### Continuously variable transmission models

Keeps the brake applied after releasing the brake pedal until the accelerator pedal is pressed. You can use this system while the vehicle is temporarily stopped, like at traffic lights and in heavy traffic.

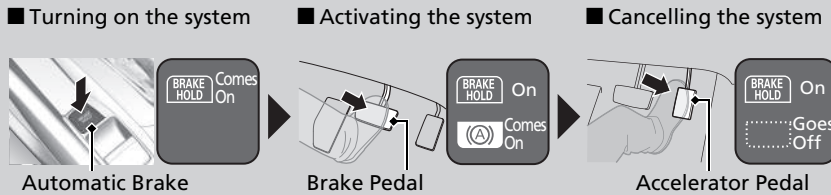

Fasten your seat belt properly, then start the engine. Press the automatic brake hold button.

- The automatic brake hold system indicator comes on. The system is turned on.

Depress the brake pedal to come to a complete stop. The shift lever must not be in **P** or **R**.

- The automatic brake hold indicator comes on. Braking is kept for up to 10 minutes.
- Release the brake pedal after the automatic brake hold indicator comes on.

Depress the accelerator pedal while the shift lever is in a position other than **P** or **N**. The system is cancelled and the vehicle starts to move.

- The automatic brake hold indicator goes off. The system continues to be on.

### Automatic Brake Hold

## ⚠ WARNING

Activating the automatic brake hold system on steep hills or slippery roads may still allow the vehicle to move if you remove your foot from the brake pedal.

If a vehicle unexpectedly moves, it may cause a crash resulting in serious injury or death.

Never activate the automatic brake hold system or rely on it to keep a vehicle from moving when stopped on a steep hill or slippery roads.

### Continuously variable transmission models

## ⚠ WARNING

Using the automatic brake hold system to park the vehicle may result in the vehicle unexpectedly moving.

If a vehicle moves unexpectedly, it may cause a crash, resulting in serious injury or death.

Never leave the vehicle when braking is temporarily kept by automatic brake hold and always park the vehicle by putting the transmission in **P** and applying the parking brake.

**Manual transmission models**

Keeps the brake applied after releasing the brake pedal until you shift into one of the gears other than [N] and:

- Release the clutch pedal on a level road or when facing downhill.
  - Release the clutch pedal and depress the accelerator pedal when facing uphill.
- You can use this system while the vehicle is temporarily stopped, like at traffic lights and in heavy traffic.

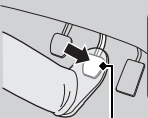
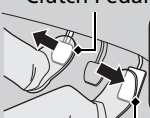
■ Turning on the system	■ Activating the system	■ Cancelling the system
 <p>Automatic Brake Hold Button</p>	 <p>Brake Pedal</p>	<p>Clutch Pedal</p>  <p>Accelerator Pedal</p>
<p>Fasten your seat belt properly, then start the engine. Press the automatic brake hold button.</p> <ul style="list-style-type: none"> <li>• The automatic brake hold system indicator comes on. The system is turned on.</li> </ul>	<p>Depress the brake pedal to come to a complete stop.</p> <ul style="list-style-type: none"> <li>• The automatic brake hold indicator comes on. Braking is kept for up to 10 minutes.</li> <li>• Release the brake pedal after the automatic brake hold indicator comes on.</li> </ul>	<p>Shift into <u>one</u> of the gears other than [N] and:</p> <ul style="list-style-type: none"> <li>• Release the clutch pedal on a level road or when facing downhill.</li> <li>• Release the clutch pedal and depress the accelerator pedal when facing uphill.</li> </ul> <p>The system is cancelled and the vehicle starts to move.</p> <ul style="list-style-type: none"> <li>• The automatic brake hold indicator goes off. The system continues to be on.</li> </ul>

Continued

■ **The system automatically cancels when:**

- You engage the parking brake.

**Continuously variable transmission models**

- You depress the brake pedal and move the shift lever to **P** or **R**.

■ **The system automatically cancels and the parking brake is applied when:**

- Braking is kept for more than 10 minutes.
- The driver's seat belt is unfastened.
- The engine is turned off.
- There is a problem with automatic brake hold system.

**Manual transmission models**

- The engine stalls.

■ **Turning off the automatic brake hold system**

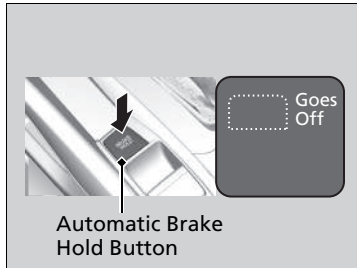

While the system is on, press the automatic brake hold button again.

- The automatic brake hold system indicator goes off.

If you want to turn off automatic brake hold while the system is in operation, press the automatic brake hold button with the brake pedal depressed.

⌘ **Automatic Brake Hold**

While the system is activated, you can turn off the engine or park the vehicle through the same procedure as you normally do.

⌘ **When Stopped** P. 642

Whether the system is on, or the system is activated, the automatic brake hold turns off once the engine is off.

**Manual transmission models**

The system turns off if the engine stalls while automatic brake hold is active or the system is on.

⌘ **Turning off the automatic brake hold system**

Make sure to turn off the automatic brake hold system before using an automated car wash.

You may hear an operating noise if the vehicle moves while the automatic brake hold system is in operation.

## Anti-lock Brake System (ABS)

### ■ ABS

Helps to prevent the wheels from locking up, and helps you to retain steering control by pumping the brakes rapidly, much faster than you.

The electronic brake distribution (EBD) system, which is part of the ABS, also balances the front-to-rear braking distribution according to vehicle loading.

You should never pump the brake pedal. Let the ABS work for you by always keeping firm, steady pressure on the brake pedal. This is sometimes referred to as “stomp and steer.”

### ■ ABS operation

The brake pedal may pulsate slightly when the ABS is working. Depress the brake pedal and keep holding the pedal firmly down. On dry pavement, you will need to press on the brake pedal very hard before the ABS activates. However, you may feel the ABS activate immediately if you are trying to stop on snow or ice.

ABS may activate when you depress the brake pedal when driving on:

- Wet or snow covered roads.
- Roads paved with stone.
- Roads with uneven surfaces, such as potholes, cracks, manholes, etc.

When the vehicle speed goes under 10 km/h (6 mph), the ABS stops.

\* Not available on all models

### ▣ Anti-lock Brake System (ABS)

#### NOTICE

The ABS may not function correctly if you use a tyre of the wrong size or type.

If the **ABS** indicator comes on while driving, there may be a problem with the system. While normal braking will not be affected, there is a possibility that the ABS will not be operating. Have your vehicle checked by a dealer immediately.

The ABS is not designed for the purpose of reducing the time or distance it takes for a vehicle to stop: It is designed to limit brake lockup which can lead to skidding and loss of steering control.

In the following cases, your vehicle may need more distance to stop than a vehicle without the ABS:

- You are driving on rough or uneven road surfaces, such as gravel or snow.
- The tyres are equipped with tyre chains\*.

The following may be observed with the ABS system:

- Motor sounds coming from the engine compartment when the brakes are applied, or when system checks are being performed after the engine has been started and while the vehicle accelerates.
- Brake pedal and/or the vehicle body vibration when ABS activates.

These vibrations and sounds are normal to ABS systems and are no cause for concern.

## Brake Assist System

---

Is designed to assist the driver by generating greater braking force when you depress the brake pedal hard during emergency braking.

### ■ Brake assist system operation

Depress the brake pedal firmly for more powerful braking.

When brake assist operates, the pedal may wiggle slightly and an operating noise may be heard. This is normal. Keep holding the brake pedal firmly down.



1.0 L and 1.5 L engine models

## Emergency Stop Signal

Activates when you brake hard while driving at 60 km/h (37 mph) or above to alert drivers behind you about sudden braking by rapidly flashing hazard warning lights. This may help to alert drivers behind you to take appropriate means to avoid a possible collision with your vehicle.

### ■ When the system activates:

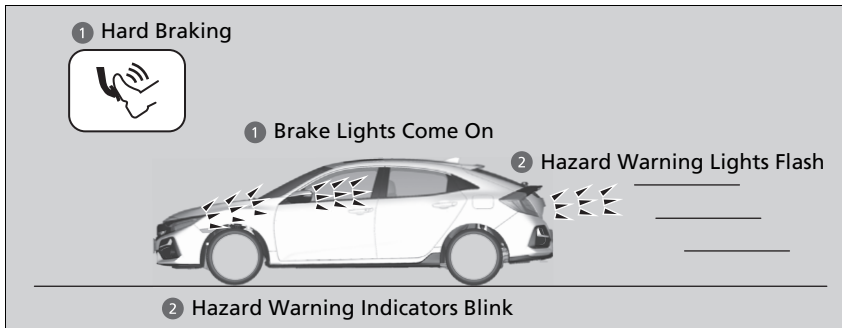

The hazard warning lights stop flashing when:

- You release the brake pedal.
- The ABS is deactivated.
- Your vehicle's decelerating speed becomes moderate.
- You press the hazard warning button.

### ▣ Emergency Stop Signal

The emergency stop signal is not a system that can prevent a possible rear-end collision caused by your hard braking. It flashes the hazard warning lights at the time you are braking hard. It is always recommended to avoid hard braking unless it is absolutely necessary.

The emergency stop signal does not activate with the hazard warning button pressed in.

If the ABS stops working for a certain period during braking, the emergency stop signal may not activate at all.

# Parking Your Vehicle

## When Stopped

1. Depress the brake pedal firmly.
2. With the brake pedal depressed, pull up the electric parking brake switch slowly, but fully.

### Continuously variable transmission models

3. Change the shift position to **P**.

### Manual transmission models

3. Move the shift lever to **R** or **1**.

### All models

4. Turn off the engine.
  - ▶ The parking brake and brake system indicator (red) goes off in about 15 seconds.

## ▣ Parking Your Vehicle

### Continuously variable transmission models

## ⚠ WARNING

The vehicle can roll away if left unattended without confirming that Park is engaged.

A vehicle that rolls away could cause a crash resulting in serious injury or death.

Always keep your foot on the brake pedal until you have confirmed that **P** is shown on the shift lever position indicator.

Do not park your vehicle near flammable objects, such as dry grass, oil, or timber. Heat from the exhaust can cause a fire.

## ▣ When Stopped

### Continuously variable transmission models

### NOTICE

The following can damage the transmission:

- Depressing the accelerator and brake pedals simultaneously.
- Holding the vehicle in place when facing uphill by depressing the accelerator pedal.
- Moving the shift lever into **P** before the vehicle stops completely.

Always confirm that the electric parking brake is set, in particular if you are parked on an incline.

▣ When Stopped

In extremely cold temperatures, the parking brake may freeze up if applied. If such temperatures are expected, do not apply the parking brake but, if parking on a slope, either turn the front wheels so they will contact the curb if the vehicle rolls down the slope or block the wheels to keep the vehicle from moving. If you do not take either precaution, the vehicle may roll unexpectedly, leading to a crash.

## Parking Sensor System\*

The corner and centre sensors monitor obstacles around your vehicle, and the beeper, driver information interface and audio/information screen\* let you know the approximate distance between your vehicle and the obstacle.

### ■ The sensor location and range

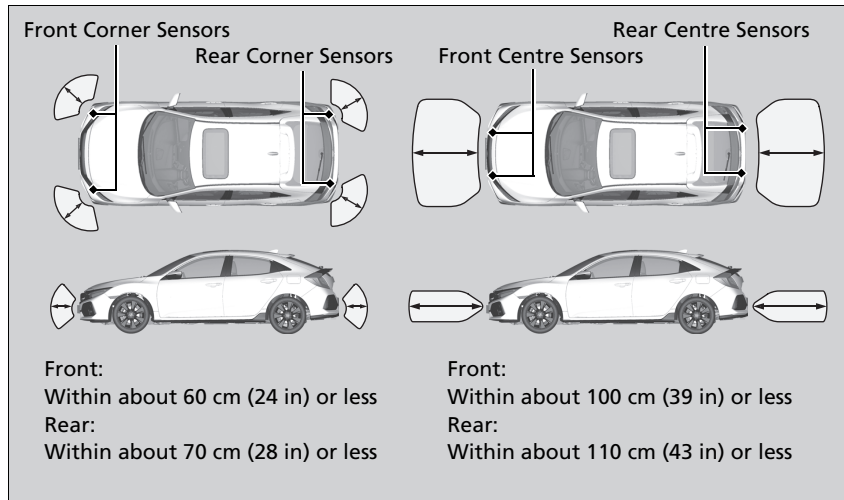

### ▣ Parking Sensor System\*

Even when the system is on, always confirm if there is no obstacle near your vehicle before parking.

The system may not work properly when:

- The sensors are covered with snow, ice, mud or dirt.
- The vehicle is on uneven surface, such as grass, bumps, or a hill.
- The vehicle has been out in hot or cold weather.
- The system is affected by devices that emit ultrasonic waves.
- Driving in bad weather.

The system may not sense:

- Thin or low objects.
- Sonic-absorptive materials, such as snow, cotton, or sponge.
- Objects directly under the bumper.

Do not put any accessories on or around the sensors.

■ Parking sensor system on and off

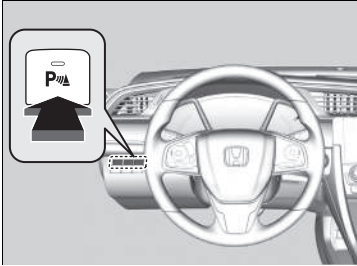

With the ignition switch in ON **[II]**\*1, press the parking sensor system button to turn on or off the system. The indicator in the button comes on when the system is on.

The front corner and front centre sensors start to detect an obstacle when the shift lever is in any position other than **[P]** or **[R]**, and the vehicle speed is less than 8 km/h (5 mph).

The front corner, rear corner and rear centre sensors start to detect an obstacle when the shift lever is in **[R]**, and the vehicle speed is less than less than 8 km/h (5 mph).

Manual transmission models

You also need to release the parking brake.

▣ Parking sensor system on and off

When you turn the ignition switch to ON **[II]**\*1, the system will be in the previously selected condition.

\*1: Models with the keyless access system have an **ENGINE START/STOP** button instead of an ignition switch.

Continued

■ When the distance between your vehicle and obstacles becomes shorter

Length of the intermittent beep	Distance between the Bumper and Obstacle		Indicator	Audio/information screen/ Driver information interface
	Corner Sensors	Centre Sensors		
Moderate	—	Front: About 100-60 cm (39-24 inches) Rear: About 110-60 cm (43-24 inches)	Blinks in Yellow*1	<div data-bbox="1211 362 1482 395" data-label="Caption"> <p>Models with Display Audio</p> </div> <div data-bbox="1267 410 1498 551" data-label="Image"> </div> <div data-bbox="1232 555 1510 604" data-label="Text"> <p>Indicators light where the sensor detects an obstacle</p> </div> <div data-bbox="1211 635 1539 662" data-label="Caption"> <p>Models with colour audio system</p> </div> <div data-bbox="1258 681 1503 782" data-label="Image"> </div> <div data-bbox="1232 793 1512 844" data-label="Text"> <p>Indicators light where the sensor detects an obstacle.</p> </div>
Short	Front: About 60-45 cm (24-18 inches) Rear: About 70-45 cm (28-18 inches)	About 60-45 cm (24-18 inches)	Blinks in Amber	
Very short	About 45-35 cm (18-14 inches)	About 45-35 cm (18-14 inches)		
Continuous	About 35 cm (14 inches) or less	About 35 cm (14 inches) or less	Blinks in Red	

\*1: At this stage, only the centre sensors detect obstacles.

## ■ Turning off All Rear Sensors

1. Make sure that the parking sensor system is not activated. Turn the ignition switch to LOCK **[0]**\*1.
2. Press and hold the parking sensor system button, and turn the ignition switch to ON **[II]**\*1.
3. Keep pressing the button for 10 seconds. Release the button when the indicator in the button flashes.
4. Press the button again. The indicator in the button goes off.
  - ▶ The beeper sounds twice. The rear sensors are now turned off.

To turn the rear sensors on again, follow the above procedure. The beeper sounds three times when the rear sensors come back on.

\*1: Models with the keyless access system have an **ENGINE START/STOP** button instead of an ignition switch.

## ▣ Turning off All Rear Sensors

When you set the gear position to **[R]**, the indicator in the parking sensor system button blinks as a reminder that the rear sensors have been turned off.

## Cross Traffic Monitor\*

Monitors the rear corner areas using the radar sensors when reversing, and alerts you if a vehicle approaching from a rear corner is detected.

The system is convenient especially when you are getting out of a parking space backwards.

### ☒ Cross Traffic Monitor\*

#### CAUTION

Cross traffic monitor cannot detect all approaching vehicles and may not detect an approaching vehicle at all.

Failure to visually confirm that it is safe to back up the vehicle before doing so may result in a collision.

Do not solely rely on the system when reversing; always also use your mirrors, and look behind and to the sides of your vehicle before reversing.

The parking sensor system's alerting buzzer overrides the cross traffic monitor buzzer when the sensors are detecting obstacles at the closest range.



## ■ How the System Works

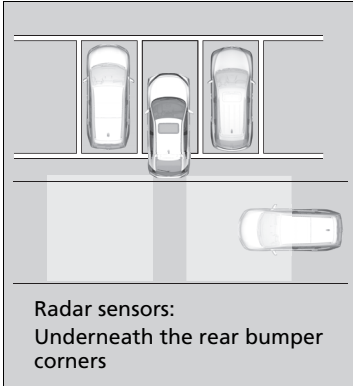

The system activates when:

- Turn the ignition switch to ON **II**\*1.
- The Cross Traffic Monitor is turned on.
  - ▣ **Cross Traffic Monitor On and Off** P. 652
  - ▣ **Customized Features** P. 396
- The shift lever is in **R**.
- Your vehicle is moving at 5 km/h (3 mph) or lower.

When a vehicle is detected approaching from a rear corner, Cross Traffic Monitor alerts you with a buzzer and a displayed warning.

## ▣ Cross Traffic Monitor\*

Cross traffic monitor may not detect or may delay detecting an approaching vehicle, or may alert detection without an approaching vehicle under the following conditions:

- An obstacle, such as another vehicle and a wall, near your vehicle's rear bumper, is blocking the radar sensor's scope.
- Your vehicle is moving at the speed of about 5 km/h (3 mph) or higher.
- A vehicle is approaching at the speed other than between about 10 km/h (6 mph) and 25 km/h (16 mph).
- The system picks up external interference such as other radar sensors from another vehicle or strong radio wave transmitted from a facility nearby.
- Either corner of the rear bumper is covered with snow, ice, mud or dirt.
- When there is bad weather.
- Your vehicle is on an incline.
- Your vehicle is tilted due to a heavy load in the rear.
- Your vehicle is reversing towards a wall, a pole, a vehicle, and so on.

The rear bumper or the sensors have been improperly repaired or the rear bumper has been deformed. Have your vehicle checked by a dealer.

\*1: Models with the keyless access system have an **ENGINE START/STOP** button instead of an ignition switch.

\* Not available on all models

*Continued*

The system will not detect a vehicle that approaches from directly behind your vehicle, nor will it provide alerts about a detected vehicle when it moves directly behind your vehicle.

The system does not provide alerts for a vehicle that is moving away from your vehicle, and it may alert for pedestrians, bicycles, or stationary objects.

☒ Cross Traffic Monitor\*



For proper operation, always keep the rear bumper corner area clean. Do not cover the rear bumper corner area with labels or stickers of any kind.

## ■ When the System Detects a Vehicle



An arrow icon appears on the side a vehicle is approaching on the audio/information screen.

## ▣ When the System Detects a Vehicle

If the  on the lower right changes to  in amber when the transmission is in **[R]**, mud, snow, ice and other debris may have accumulated in the vicinity of the sensor. The system is temporarily cancelled. Check the bumper corners for any obstructions, and thoroughly clean the area if necessary.

If the  comes on when the transmission is in **[R]**, there may be a problem with the Cross Traffic Monitor system. Do not use the system and have your vehicle checked by a dealer.

If the display remains the same with the transmission in **[R]**, there may be a problem with the rear camera system and the Cross Traffic Monitor system. Do not use the system and have your vehicle checked by a dealer.

Continued

## ■ Cross Traffic Monitor On and Off

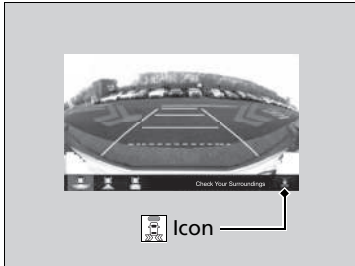

Tap to turn the system on and off. The indicator (green) comes on with the system on.

You can also switch on and off the system from the customized feature on the audio/information screen.

➤ **Customized Features** P. 396

# Multi-View Rear Camera\*

## About Your Multi-View Rear Camera

The audio/information screen can display your vehicle's rear view. The display automatically changes to the rear view when the transmission is put into **R**.

### Multi-View Rear Camera Display Area

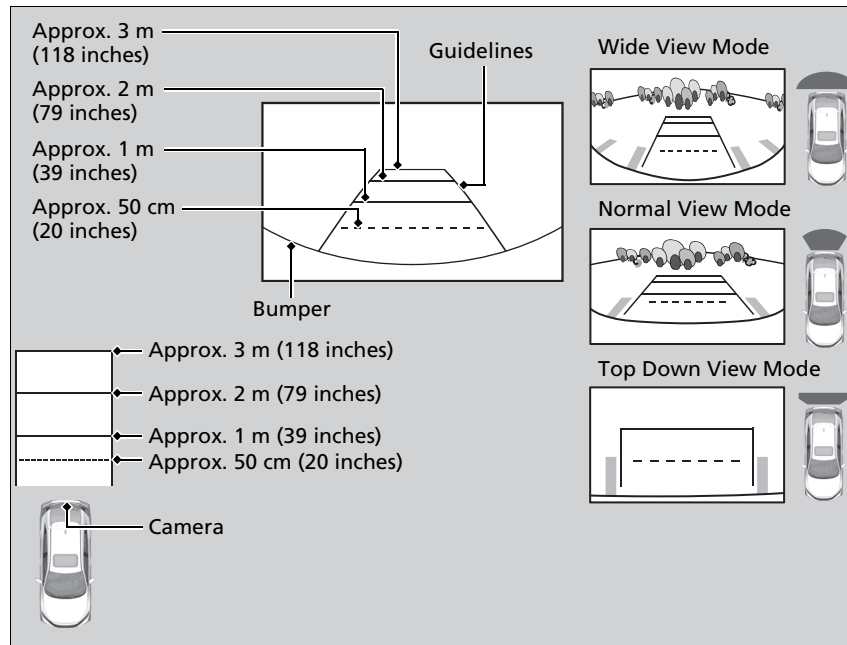

\* Not available on all models

### About Your Multi-View Rear Camera

The rear camera view is restricted. You cannot see the corner ends of the bumper or what is underneath the bumper. Its unique lens also makes objects appear closer or farther than they actually are.

Visually confirm that it is safe to drive before backing up. Certain conditions (such as weather, lighting, and high temperatures) may also restrict the rear view. Do not rely on the rearview display which does not give you all information about conditions at the back of your vehicle.

If the camera lens is covered with dirt or moisture, use a soft, moist cloth to keep the lens clean and free of debris.

You can change the **Fixed Guideline** and **Dynamic Guideline** settings.

➤ **Customized Features** P. 396

#### Fixed Guideline

**On:** Guidelines appear when you put the transmission into **R**.

**Off:** Guidelines do not appear.

#### Dynamic Guideline

**On:** Guidelines move according to the steering wheel direction.

**Off:** Guidelines do not move.

Continued

You can view three different camera modes on the rearview display.

Touch the appropriate icon to switch the mode.



: Wide view mode



: Normal view mode



: Top down view mode

- If the last used viewing mode was Wide or Normal view mode, the same mode is selected the next time you put the transmission into **R**.
- If Top down view mode was last used before you turned off the engine, Wide View mode is selected next time you turn the ignition switch to ON **II**\*1 and put the transmission into **R**.
- If Top down view mode was last used more than 10 seconds after you shift from **R**, Wide View mode is selected the next time you put the transmission into **R**.

\* 1: Models with the smart entry system have an **ENGINE START/STOP** button instead of an ignition switch.

# Refueling

## Fuel Information

### ■ Fuel recommendation

#### 1.0 L and 1.5 L engine models

**EN 228 standards petrol/gasohol fuel**  
**Unleaded premium petrol/gasohol up to E10 (90% petrol and 10% ethanol), research octane number 95 or higher**

Your vehicle is designed to operate on premium unleaded petrol with a research octane of 95 or higher.

If this octane grade is unavailable, regular unleaded petrol with a research octane of 91 or higher may be used temporarily.

The use of regular unleaded petrol can cause metallic knocking noises in the engine and will result in decreased engine performance. The long-term use of regular-grade petrol can lead to engine damage.

#### 2.0 L engine models without rear fog light

**Unleaded premium petrol, research octane number 95 or higher**

Your vehicle is designed to operate on premium unleaded petrol with a research octane of 95 or higher.

If this octane grade is unavailable, regular unleaded petrol with a research octane of 91 or higher may be used temporarily.

The use of regular unleaded petrol can cause metallic knocking noises in the engine and will result in decreased engine performance. The long-term use of regular-grade petrol can lead to engine damage.

### » Fuel Information

#### NOTICE

Use of petrol that contains lead presents the following risks:

- Damage to the exhaust system including the catalytic converter
- Damage to the engine and fuel system
- Detrimental effects on the engine and other systems

#### 1.0 L and 1.5 L engine models



#### 2.0 L engine models with rear fog light



Continued

2.0 L engine models with rear fog light

**EN 228 standards petrol/gasohol fuel  
Unleaded premium petrol/gasohol up to E10 (90% petrol and 10% ethanol), research octane number 95 or higher**

Use of lower octane petrol can cause occasional metallic knocking noise in the engine and will result in decreased engine performance.

We recommend that you use a research octane of 98 or higher to maximize the performance of the engine.

Use of petrol with a research octane less than 91 can lead to engine damage.

■ **Fuel tank capacity: 46.9 L (10.3 Imp gal)**

Except 2.0 L engine models

Models without service reminder system

Models without service book

■ **Engine cleaner**

Regular use of Injector Cleaning Additives may be required depend on quality of local fuel.

► Fuel Information

Models with rear fog light

***Oxygenated Fuels***

Oxygenated fuels are blended with petrol and ethanol or ether compound. Your vehicle is also designed to operate on oxygenated fuels containing up to 10% ethanol by volume and up to 22% ETBE by volume, based on the EN 228 standards. For more information, ask your dealer.



## How to Refuel

Your fuel tank is not equipped with a fuel filler cap. You can insert the filler nozzle directly into the filler neck. The tank seals itself again when you pull out the filler nozzle.



1. Stop your vehicle with the service station pump on the left side of the vehicle in the rear.
2. Turn off the engine.
3. Press the area indicated by the arrow to release the fuel fill door. You will hear a click.
  - ▶ Driver's door must be unlocked.
  - ▶ **Locking/Unlocking the Doors from the Inside** P. 201

### ▶▶ How to Refuel

## ⚠ WARNING

**Petrol is highly flammable and explosive. You can be burned or seriously injured when handling fuel.**

- Stop the engine, and keep heat, sparks, and flame away.
- Handle fuel only outdoors.
- Wipe up spills immediately.

The fuel filler opening is designed to accept only service station filler nozzles for refueling. Use of smaller diameter tubes (e.g., those used to siphon fuel for other uses) or other non-service station devices can damage the area in and around the filler opening.

Use the lock tab or the master door lock switch to unlock the fuel fill door.

The vehicle doors and fuel fill door automatically relock if the remote unlock function is used. This can be deactivated by briefly opening then closing the driver's door.

The fuel fill door and its latching mechanism can be permanently damaged if the fuel fill door is forced closed when the driver's door is locked.

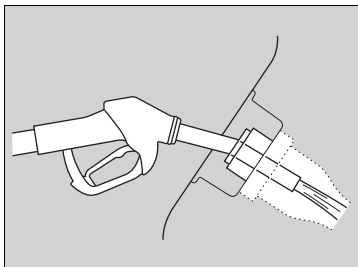

4. Place the end of the filler nozzle on the lower part of filler opening, then insert it slowly and fully.
  - Make sure that the end of the filler nozzle goes down along with the filler pipe.
  - Keep the filler nozzle level.
  - When the tank is full, the filler nozzle will click off automatically.
  - After filling, wait about five seconds before removing the filler nozzle.
5. Shut the fuel fill door by hand.

#### How to Refuel

The filler nozzle automatically stops to leave space in the fuel tank so that fuel does not overflow as a result of changes in air temperature.

Do not continue to add fuel after the filler nozzle has automatically stopped. Additional fuel can exceed the full tank capacity.

If you have to refuel your vehicle from a portable container, use the funnel provided with your vehicle.

► **Refueling From a Portable Fuel Container**  
P. 802

# Fuel Economy and CO<sub>2</sub> Emissions

## Improving Fuel Economy and Reducing CO<sub>2</sub> Emissions

Achieving fuel economy and reducing CO<sub>2</sub> emissions is dependent on several factors, including driving conditions, load weight, idling time, driving habits, and vehicle condition. Depending on these and other factors, you may not achieve the rated fuel economy of this vehicle.

### Maintenance and Fuel Economy

You can optimize your fuel economy with proper maintenance of your vehicle. Follow the maintenance schedule and, if necessary, consult your warranty booklet. On vehicles without service reminder system, follow the Maintenance schedule.

#### ➤ Maintenance Schedule\* P. 674

- Use engine oil with the viscosity recommended.
  - Recommended Engine Oil P. 687
- Maintain the specified tyre pressure.
- Do not load the vehicle with excess luggage.
- Keep your vehicle clean. A buildup of snow or mud on your vehicle's underside adds weight and increases wind resistance.

\* Not available on all models

### ➤ Improving Fuel Economy and Reducing CO<sub>2</sub> Emissions

Direct calculation is the recommended method to determine actual fuel consumed while driving.

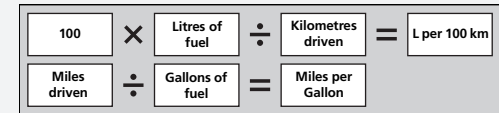

# Turbo Engine Vehicle

## Handling Precautions

The turbocharger is a high-precision device to obtain greater horsepower by delivering a large volume of compressed air into the engine using a turbine driven by the engine's exhaust gas pressure.

- When the engine is cold just after starting, avoid revving the engine or sudden acceleration.
- Always replace the engine oil and engine oil filter according to the maintenance schedule. The turbine rotates at very high speeds over 100,000 rpm and its temperature reaches over 700°C. It is lubricated and cooled by engine oil. If you fail to replace the engine oil and filter at the scheduled distance or interval, deteriorated engine oil may cause failure such as sticking and abnormal noise of the turbine bearing.

### ☒ Turbo Engine Vehicle

The scheduled maintenance intervals for replacing the filter is indicated on the driver information interface. Follow the information of when to replace them.

☒ **Service Reminder System\*** P. 665

☒ **Oil Monitor System\*** P. 670

☒ **Maintenance Schedule\*** P. 674

☒ **Recommended Engine Oil** P. 687

The temperature gauge pointer is at the upper level when you restart the engine after driving under high load conditions such as at high speed or in hilly terrain. This is normal. The gauge goes down after you idle or drive the vehicle for about one minute.

# Maintenance

This chapter discusses basic maintenance.



## Before Performing Maintenance

Inspection and Maintenance .....	662
Safety When Performing Maintenance ....	663
Parts and Fluids Used in Maintenance Service .....	664
About Your Maintenance Service .....	664
<b>Service Reminder System</b> * .....	665
<b>Oil Monitor System</b> * .....	670
<b>Maintenance Schedule</b> * .....	674
<b>Maintenance Under the Bonnet</b>	
Maintenance Items Under the Bonnet ..	682
Opening the Bonnet .....	685
Recommended Engine Oil .....	687

Oil Check.....	690
Adding Engine Oil.....	693
Engine Coolant.....	694
Transmission Fluid.....	698
Brake/Clutch* Fluid.....	699
Refilling Window Washer Fluid.....	701
Fuel Filter .....	701
<b>Replacing Light Bulbs</b> .....	702
<b>Checking and Maintaining Wiper Blades</b> .....	711
<b>Checking and Maintaining Tyres</b>	
Checking Tyres .....	716
Wear Indicators.....	717

Tyre Service Life .....	717
Tyre and Wheel Replacement.....	718
Tyre Rotation .....	719
Snow Traction Devices .....	720
<b>Battery</b> .....	722
<b>Remote Transmitter Care</b>	
Replacing the Button Battery .....	727
<b>Heating System*/Climate Control System* Maintenance</b> .....	729
<b>Cleaning</b> .....	732
Interior Care .....	732
Exterior Care.....	735
<b>Accessories and Modifications</b> .....	738

\* Not available on all models

# Before Performing Maintenance

## Inspection and Maintenance

For your safety, perform all listed inspections and maintenance to keep your vehicle in good condition. If you become aware of any abnormality (noise, smell, insufficient brake fluid, oil residue on the ground, etc.), have your vehicle inspected by a dealer. Refer to the Service Book\* that came with your vehicle/maintenance schedule in this owner's manual for detailed maintenance and inspection information.

➤ **Maintenance Schedule\*** P. 674

### Types of Inspection and Maintenance

#### ■ Daily inspections

Perform inspections before long distance trips, when washing the vehicle, or when refueling.

#### ■ Periodic inspections

- Check the brake/clutch\* fluid level monthly.
  - **Brake/Clutch\* Fluid** P. 699
- Check the tyre pressure monthly. Examine the tread for wear and foreign objects.
  - **Checking and Maintaining Tyres** P. 716
- Check the operation of the exterior lights monthly.
  - **Replacing Light Bulbs** P. 702
- Check the condition of the wiper blades at least every six months.
  - **Checking and Maintaining Wiper Blades** P. 711

## Safety When Performing Maintenance

Some of the most important safety precautions are given here. However, we cannot warn you of every conceivable hazard that can arise in performing maintenance. Only you can decide whether you should perform a given task.

### Maintenance Safety

- To reduce the possibility of fire or explosion, keep cigarettes, sparks, and flames away from the battery and all fuel related parts.
- Never leave rags, towels, or other flammable objects under the bonnet.
  - ▶ Heat from the engine and exhaust can ignite them, causing a fire.
- To clean parts, use a commercially available degreaser or parts cleaner, not petrol.
- Wear eye protection and protective clothing when working with the battery or compressed air.
- Engine exhaust contains carbon monoxide, which is poisonous and can kill you.
  - ▶ Only operate the engine if there is sufficient ventilation.

### Vehicle Safety

- The vehicle must be in a stationary condition.
  - ▶ Make sure your vehicle is parked on level ground, the parking brake is set, and the engine is off.
- Be aware that hot parts can burn you.
  - ▶ Make sure to let the engine and exhaust system cool thoroughly before touching vehicle parts.
- Be aware that moving parts can injure you.
  - ▶ Do not start the engine unless instructed, and keep your hands and limbs away from moving parts.
  - ▶ Do not open the bonnet while the Auto Idle Stop function\* is activated.

\* Not available on all models

#### ▣ Safety When Performing Maintenance

### **⚠ WARNING**

Improperly maintaining this vehicle or failing to correct a problem before driving can cause a crash in which you can be seriously hurt or killed.

Always follow the inspection and maintenance recommendations and schedules in this owner's manual/Service Book.

### **⚠ WARNING**

Failure to properly follow maintenance instructions and precautions can cause you to be seriously hurt or killed.

Always follow the procedures and precautions in this owner's manual.

## Parts and Fluids Used in Maintenance Service

The use of Honda genuine parts and fluids is recommended when maintaining and servicing your vehicle. Honda genuine parts are manufactured according to the same high quality standards used in Honda vehicles.

## About Your Maintenance Service

If the service reminder system is available in your vehicle, you are informed by the driver information interface when your vehicle's maintenance services are due. Refer to the service book that came with your vehicle for an explanation of the service item codes that appear on the display.

📖 **Service Reminder System**\* P. 665

If the service reminder system is not available, follow the maintenance schedules in the service book that came with your vehicle.

If your vehicle is without the service book, follow the maintenance schedule in this owner's manual.

📖 **Maintenance Schedule**\* P. 674

### 📖 Parts and Fluids Used in Maintenance Service

#### NOTICE

Do not press the engine cover\* forcibly. This may damage the engine cover and component parts.

### 📖 About Your Maintenance Service

#### Models with service reminder system

If you are planning to take your vehicle outside the service reminder system applied countries, consult a dealer for how to record your service reminder information and schedule your maintenance service under the conditions of that country.



## Service Reminder System\*

Provides information of which service items are to be performed. Service items are represented by a code and icon. The system tells you when to take your vehicle to a dealer by days remaining.

When the next maintenance service timing is near, coming or passed, a warning icon will also appear on the driver information interface every time you turn the ignition switch to ON \*1.

\*1: Models with the keyless access system have an **ENGINE START/STOP** button instead of an ignition switch.



\* Not available on all models

### ▣ Service Reminder System\*

You can choose to have a corresponding warning message displayed with the warning icon on the driver information interface.

The maintenance schedule may not display correct information if you disconnect or remove the battery for an extended period. If this occurs, see a dealer.

## Displaying the Service Reminder Information

1. Turn the ignition switch to ON **II**\*1.
2. Press the  (display/information) button several times until  is displayed.
3. Press the **ENTER** button to go to the service reminder information screen. The maintenance item(s) appears on the driver information interface.

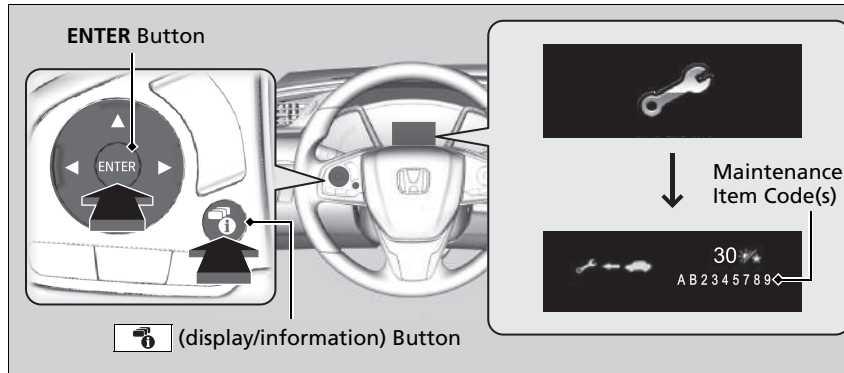

The system message indicator (ⓘ) comes on along with the service reminder information.



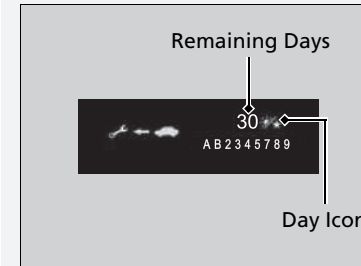

## Displaying the Service Reminder Information

Based on engine operating conditions and engine oil conditions, the system calculates the remaining days before the next service is to be performed.



\* 1: Models with the keyless access system have an **ENGINE START/STOP** button instead of an ignition switch.

**Warning Icons and Service Reminder Information on the Driver Information Interface**

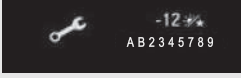
Warning Icon	Service Reminder Information	Explanation	Information
<p><b>Service Due Soon</b></p> 		<p>One or more of the service items are required in less than 30 days. The remaining days are estimated based on your driving conditions.</p>	<p>The remaining days will be counted down per day.</p>
<p><b>Service Due Now</b></p> 		<p>One or more of the service items are required in less than 10 days. The remaining days are estimated based on your driving conditions.</p>	<p>Have the indicated service performed as soon as possible.</p>
<p><b>Service Over Due</b></p> 		<p>The indicated maintenance service is still not done after the remaining time reaches 0.</p>	<p>Your vehicle has passed the service required point. Immediately have the service performed and make sure to reset the service reminder system.</p>

## ■ Service Reminder Items

Service items displayed on the driver information interface are in code and icon. For an explanation of the service reminder codes and icons, refer to the service book that came with your vehicle.

### ■ Availability of the Service Reminder System

Even if the service reminder information appears on the driver information interface while pressing the  (display/information) button, this system is not available in some countries. Refer to the service book that came with your vehicle, or ask a dealer if you can use the service reminder system.

### ▶ Availability of the Service Reminder System

If you are planning to take your vehicle outside the service reminder system applied countries, consult a dealer on how to record your service reminder information and schedule your maintenance service under the conditions of that country.

## ■ Resetting the Display

Reset the service reminder information display if you have performed the maintenance service.

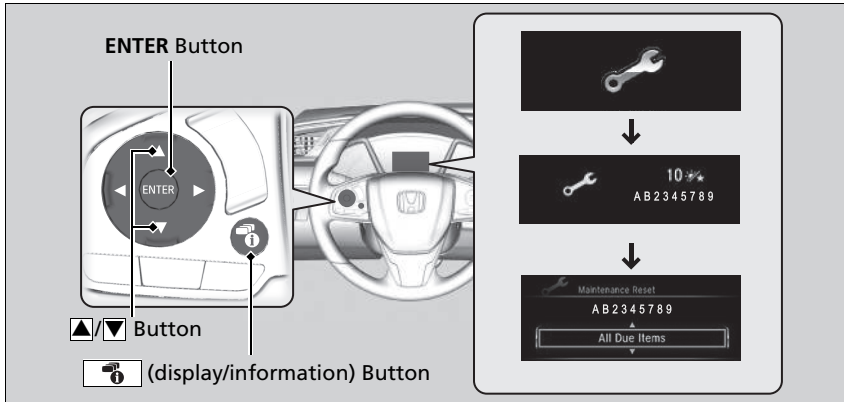

1. Turn the ignition switch to ON \*1.
2. Press the (display/information) button repeatedly until the appears.
3. Press the **ENTER** button.
4. Press and hold the **ENTER** button for about 10 seconds to enter the reset mode.
5. Press button to select a maintenance item to reset, or to select **All Due Items** (You can also select **Cancel** to end the process).
6. Press the **ENTER** button to reset the selected item.
7. Repeat from step 4 for other items you wish to reset.

\*1: Models with the keyless access system have an **ENGINE START/STOP** button instead of an ignition switch.

## ▶▶ Resetting the Display

### NOTICE

Failure to reset the service reminder information after a maintenance service results in the system showing incorrect maintenance intervals, which can lead to serious mechanical problems.

### Models with Display Audio

You can also reset the service reminder system information display using the audio/information screen.

▶ **Customized Features** P. 396

The dealer will reset the service reminder information display after completing the required maintenance service. If someone other than a dealer performs maintenance service, reset the service reminder information display yourself.

## Oil Monitor System\*

The warning message notifies you when to change the engine oil, or when to bring your vehicle to a dealer for indicated maintenance services.

## Displaying the Oil Monitor System Information

Certain maintenance items due soon, along with the estimated remaining oil life, appear on the driver information interface. You can view them on the oil monitor system information screen at any time.

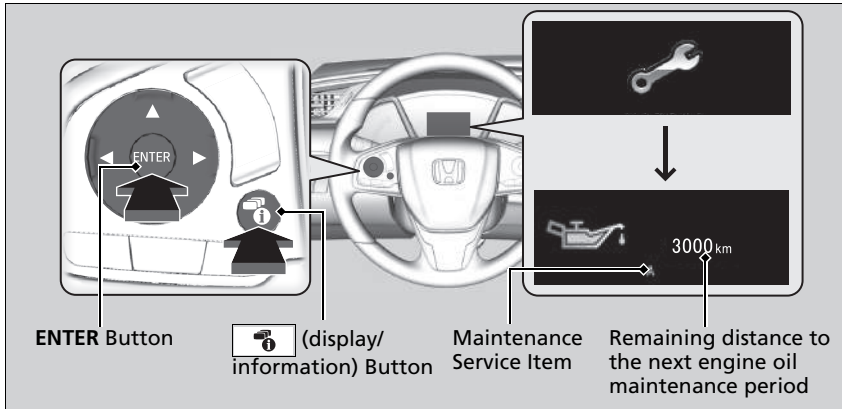

1. Turn the ignition switch to ON \*1.
2. Press the (display/information) button several times until is displayed.
3. Press **ENTER** button to go to the oil monitor system information screen. The maintenance service item and the remaining distance appears on the driver information interface along with maintenance items due soon.

The system message indicator () stays on in the instrument panel after the maintenance period reached. Have the indicated maintenance done by a dealer immediately.

\*1: Models with the keyless access system have an **ENGINE START/STOP** button instead of an ignition switch.

### Displaying the Oil Monitor System Information

Based on the engine operating and engine oil conditions, the remaining distance to the next maintenance period is calculated and displayed.









By driving conditions, actual travel distance might be shorter than the displayed distance.

The type and content of the maintenance service items are as follows:

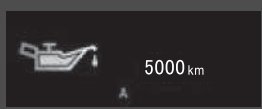
- A. Replace engine oil
- B. Replace engine oil and oil filter

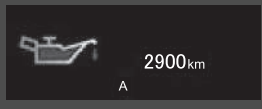
Independent of the oil monitor system information, perform maintenance after 1 year has elapsed since the last oil change.

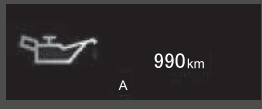
### Oil Monitor System Information on the Driver Information Interface

Warning Icon	Oil Life Display	Information
<p><b>Normal</b></p> 		When you reset the remaining distance after an oil change, a series of dots will appear in the oil life display. These dots will remain displayed until the system determines, based on the driving conditions, the remaining distance until the next oil change.
		When you select the oil monitor system information screen, it displays codes for maintenance items due at the next engine oil change, along with the remaining distance.
<p><b>Service Due Soon</b></p> 		The engine oil is approaching the end of its service life.
<p><b>Service Due Now</b></p> 		The engine oil has almost reached the end of its service life, and the maintenance service item should be inspected and serviced as soon as possible.
<p><b>Service Over Due</b></p> 		The engine oil life has passed. The maintenance service item must be inspected and serviced immediately.



## ■ Resetting the Display

Reset the engine oil monitor system information if you have performed the maintenance service.

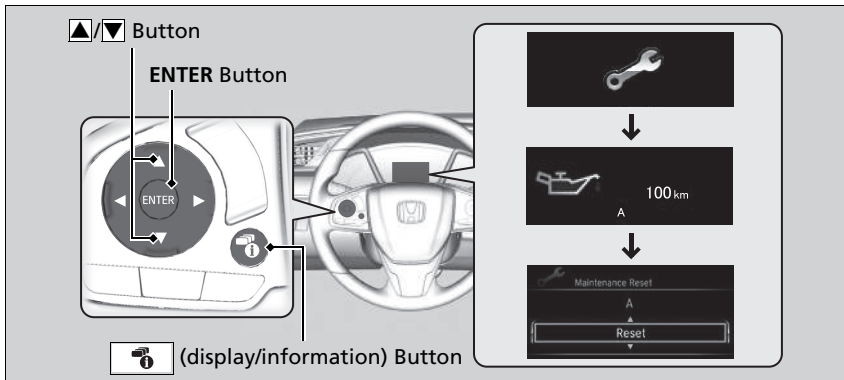

1. Turn the ignition switch to ON \*1.
2. Press the (display/information) button several times until is displayed.
3. Press **ENTER** button to go to the oil monitor system information screen.
4. Press and hold the **ENTER** button for about 10 seconds to enter the reset mode.
5. Press button to select **Reset**.  
(You can also select **Cancel** to end the process).
6. Press the **ENTER** button to reset the selected item.
  - ▶ When the oil monitor system information display is reset, the engine oil life is reset to ----- **km** (----- **miles**).

\*1: Models with the keyless access system have an **ENGINE START/STOP** button instead of an ignition switch.

## ▣ Resetting the Display

### NOTICE

Failure to reset the engine oil life after a maintenance service results in the system showing incorrect maintenance intervals, which can lead to serious mechanical problems.

### Models with Display Audio

You can also reset the oil monitor system information display using the audio/information screen.

➔ **Customized Features** P. 396

The dealer will reset the engine oil life display after completing the required maintenance service. If someone other than a dealer performs maintenance service, reset the engine oil life display yourself.

## Maintenance Schedule\*

If your vehicle comes with the service book, the maintenance schedule for your vehicle is available in the book. For vehicles without the service book, refer to the following maintenance schedules.

The maintenance schedule outlines the minimum required maintenance that you should perform to ensure the troublefree operation of your vehicle. Due to regional and climatic differences, some additional servicing may be required. Please consult your warranty booklet for a more detailed description.

Maintenance work should be performed by properly trained and equipped technicians. Your authorised dealer meets all of these requirements.

**Except European, Ukrainian and South African models**

Service at the indicated distance or time - whichever comes first.	km X 1,000	20	40	60	80	100	120	140	160	180	200
	miles X 1,000	12.5	25.0	37.5	50.0	62.5	75.0	87.5	100	112.5	125.0
	months	12	24	36	48	60	72	84	96	108	120
Replace engine oil*1	When indicator comes on or 1 year										
Replace engine oil filter*1	When indicator comes on or 2 years										
Add Genuine Injector Cleaner Agent*2, *3	Every 10,000 km (6,000 miles) or 1 year										
Replace air cleaner element	Every 30,000 km (18,500 miles)										
Inspect valve clearance	Every 120,000 km (75,000 miles)*4										
Replace fuel filter*5				•					•		
Replace spark plugs	Every 100,000 km (62,500 miles)										
Replace timing belt*6					•						•
Inspect drive belts		•		•		•		•			•
Replace engine coolant	At 200,000 km (125,000 miles) or 10 years, thereafter every 100,000 km (62,500 miles) or 5 years										

\*1: Only severe schedule is required in some countries: refer to local warranty booklet.

\*2: Regular use of injector cleaner is required for models designated for Cayman.

\*3: Regular use of injector cleaner may be required for models designated for the following countries, it will depend on the quality of the fuel used. Consult your dealer for details: Tanzania, Zambia, Swaziland, Seychelles, Reunion, Mozambique, Mauritius, Melilla, Kenya, Lesotho, Ceuta, Canary Islands, Botswana, Jamaica

\*4: Sensory Method

Adjust the valves during service 120,000 km (75,000 miles) if they are noisy.

\*5: Refer to page 701 for replacement information under severe driving conditions.

\*6: 1.0 L engine models

►► Maintenance Schedule\*►

Service at the indicated distance or time - whichever comes first.	km X 1,000		20	40	60	80	100	120	140	160	180	200
	miles X 1,000		12.5	25.0	37.5	50.0	62.5	75.0	87.5	100	112.5	125.0
	months		12	24	36	48	60	72	84	96	108	120
Replace transmission fluid	MT*1	Normal						•				
		Severe			•			•			•	
	MT*2	Normal	Every 120,000 km (75,000 miles) or 6 years									
		Severe			•			•			•	
	CVT		•		•		•		•		•	
Inspect front and rear brakes	Every 10,000 km (6,000 miles) or 6 months											
Replace brake fluid	Every 3 years											
Replace dust and pollen filter	•	•	•	•	•	•	•	•	•	•	•	•
Check expiry date for tyre repair kit bottle	Every year											
Rotate tyres (Check tyre inflation and condition at least once per month)	Every 10,000 km (6,000 miles)											
<b>Visually inspect the following items:</b>												
Tie rod ends, steering gear box, and boots	Every 10,000 km (6,000 miles) or 6 months											
Suspension components												
Driveshaft boots												
Brake hoses and lines (including ABS)	•	•	•	•	•	•	•	•	•	•	•	•
All fluid levels and condition of fluid												
Exhaust system												
Fuel lines and connections												

\*1: Except 2.0 L engine models

\*2: 2.0 L engine models

**Ukrainian models**

Service at the indicated distance or time - whichever comes first.	km X 1,000 months	15	30	45	60	75	90	105	120	135	150	165	180	195
		12	24	36	48	60	72	84	96	108	120	132	144	156
Replace engine oil		When indicator comes on or 1 year												
Replace engine oil filter		When indicator comes on or 2 years												
Add genuine injector cleaner agent		Every 10,000 km or 1 year												
Replace air cleaner element		Every 30,000 km												
Inspect valve clearance* <sup>1</sup>		Every 120,000 km												
Replace fuel filter* <sup>2</sup>							•							•
Replace spark plugs		Every 120,000 km (Inspect : 15,000 km)												
Replace timing belt* <sup>3</sup>		Every 120,000 km or 6 years												
Inspect drive belts		•	•	•	•	•	•	•	•	•	•	•	•	•
Replace engine coolant		At 200,000 km or 10 years, thereafter every 100,000 km or 5 years												
Replace transmission fluid	MT				•				•					•
	CVT			•			•			•				•

\*1: Sensory Method

Adjust the valves during service 120,000 km if they are noisy.

\*2: Refer to page 701 for replacement information under severe driving conditions.

\*3: 1.0 L engine models

►► Maintenance Schedule\* ►

Service at the indicated distance or time - whichever comes first.	km X 1,000	15	30	45	60	75	90	105	120	135	150	165	180	195
	months	12	24	36	48	60	72	84	96	108	120	132	144	156
Inspect front and rear brakes		•	•	•	•	•	•	•	•	•	•	•	•	•
Replace brake fluid		Every 3 years												
Replace dust and pollen filter		•	•	•	•	•	•	•	•	•	•	•	•	•
Check light alignment		•	•	•	•	•	•	•	•	•	•	•	•	•
Test drive (noise, stability, dash board operation)		•	•	•	•	•	•	•	•	•	•	•	•	•
Check expiry date for tyre repair kit bottle		Every year												
Rotate tyres (Check tyre inflation and condition at least once per month)		•	•	•	•	•	•	•	•	•	•	•	•	•
<b>Visually inspect the following items:</b>														
Tie rod ends, steering gear box, and boots														
Suspension components														
Driveshaft boots														
Brake hoses and lines (including ABS)		•	•	•	•	•	•	•	•	•	•	•	•	•
All fluid levels and condition of fluid														
Exhaust system														
Fuel lines and connections														

**Except European, Ukrainian and South African models**

If you drive your vehicle under severe conditions, you must have the following items served to the maintenance schedule indicated as Severe.

Items	Condition
Transmission fluid	B, D

▶▶ Maintenance Schedule\*

**Except European, Ukrainian and South African models**

The condition is considered as severe when you drive:  
 B. In extremely hot temperature above 35°C.  
 D. With a trailer towing\*, or loaded roof rack, or in mountains.

\* Not available on all models

## Maintenance Record (On Vehicles without Service Book)

Have your servicing dealer record all required maintenance below. Keep receipts for all work done on your vehicle.

Except European, Ukrainian and South African models

	Km or Month	Date	Sign or Stamp
<b>20,000 km</b> 12,500 Mi. (or 12 Mo.)			
<b>40,000 km</b> 25,000 Mi. (or 24 Mo.)			
<b>60,000 km</b> 37,500 Mi. (or 36 Mo.)			
<b>80,000 km</b> 50,000 Mi. (or 48 Mo.)			
<b>100,000 km</b> 62,500 Mi. (or 60 Mo.)			
<b>120,000 km</b> 75,000 Mi. (or 72 Mo.)			
<b>140,000 km</b> 87,500 Mi. (or 84 Mo.)			
<b>160,000 km</b> 100,000 Mi. (or 96 Mo.)			
<b>180,000 km</b> 112,500 Mi. (or 108 Mo.)			
<b>200,000 km</b> 125,000 Mi. (or 120 Mo.)			



**Ukrainian models**

	Km or Month	Date	Sign or Stamp
<b>15,000 km</b> (or 12 Mo.)			
<b>30,000 km</b> (or 24 Mo.)			
<b>45,000 km</b> (or 36 Mo.)			
<b>60,000 km</b> (or 48 Mo.)			
<b>75,000 km</b> (or 60 Mo.)			
<b>90,000 km</b> (or 72 Mo.)			
<b>105,000 km</b> (or 84 Mo.)			
<b>120,000 km</b> (or 96 Mo.)			
<b>135,000 km</b> (or 108 Mo.)			
<b>150,000 km</b> (or 120 Mo.)			
<b>165,000 km</b> (or 132 Mo.)			
<b>180,000 km</b> (or 144 Mo.)			
<b>195,000 km</b> (or 156 Mo.)			

# Maintenance Under the Bonnet

## Maintenance Items Under the Bonnet

1.0 L engine models

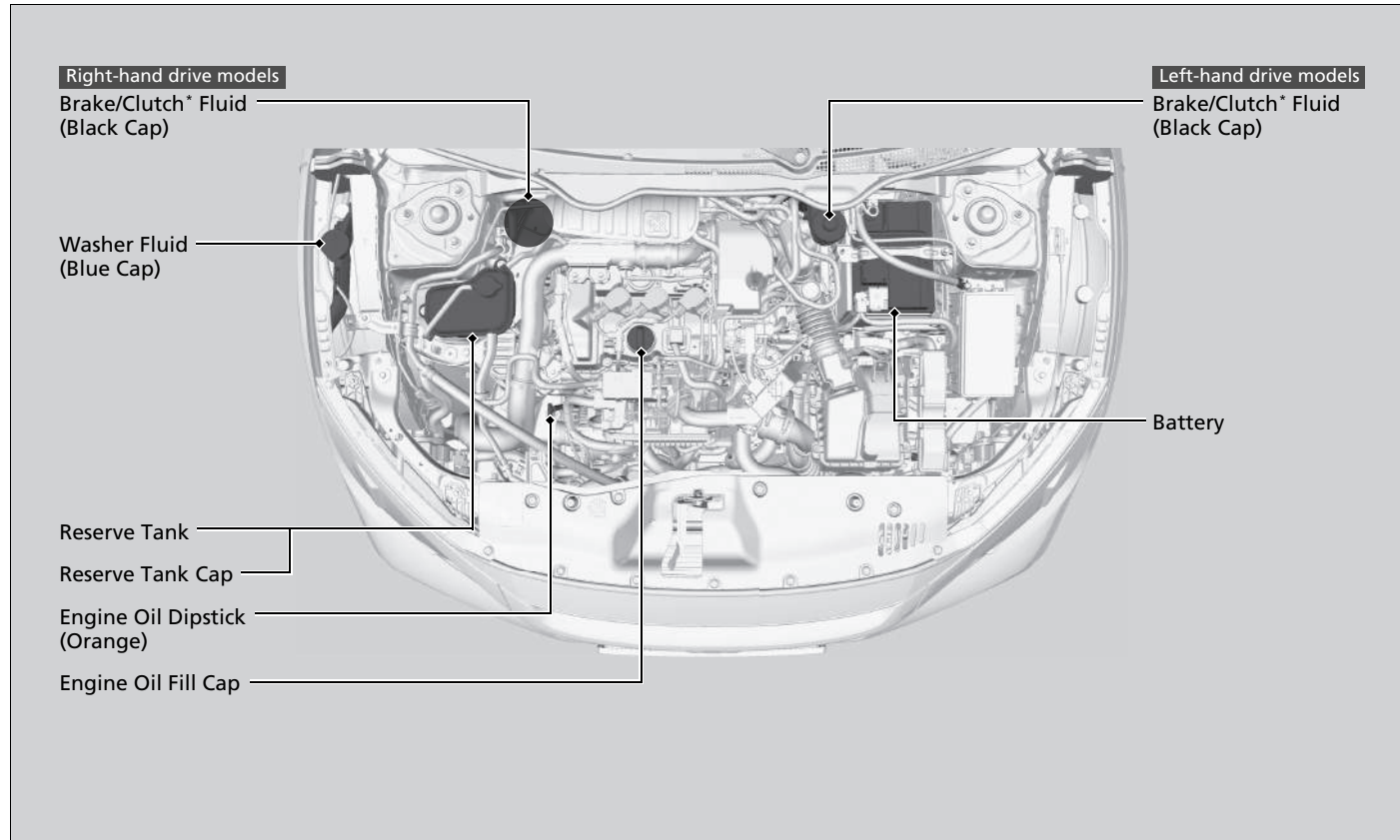

1.5 L engine models

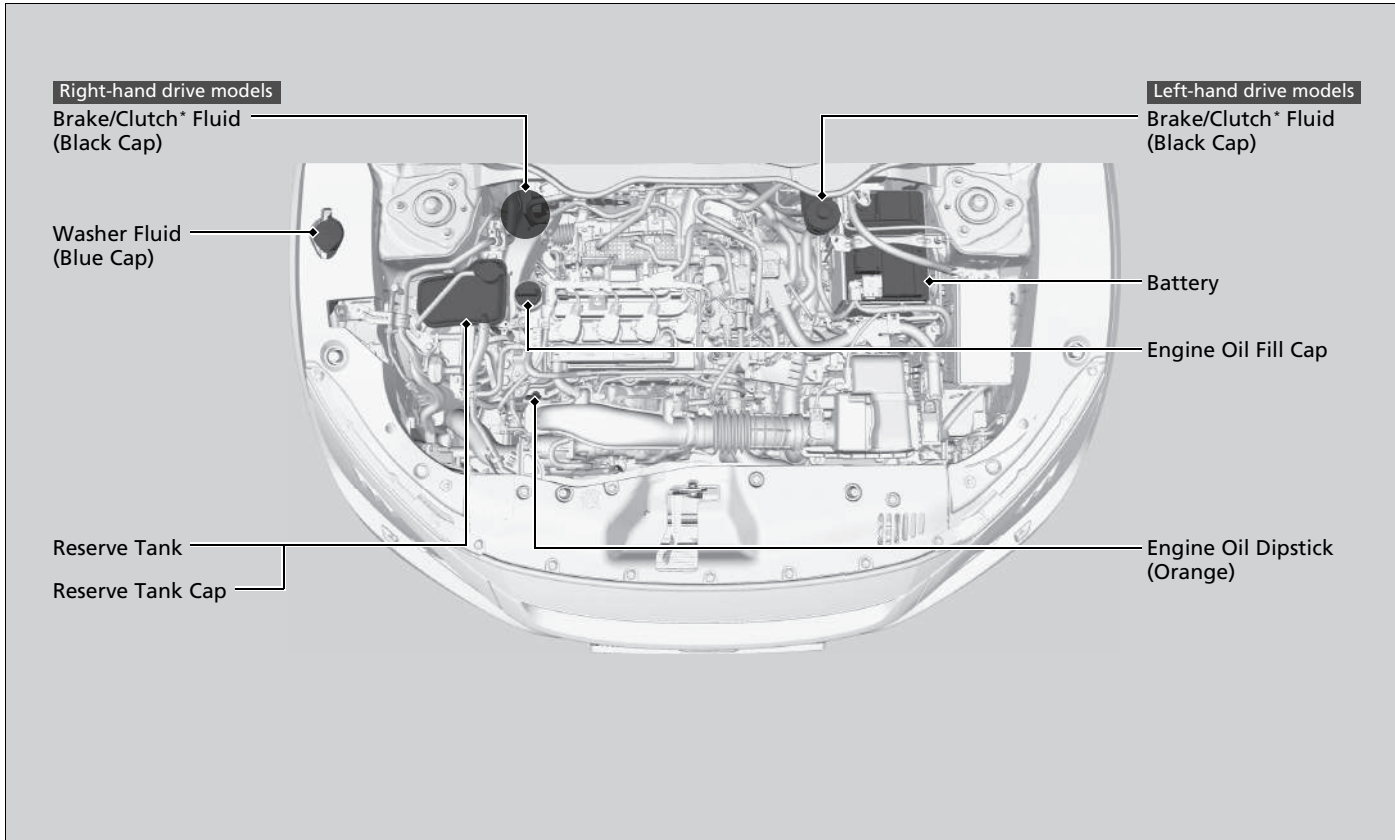

\* Not available on all models

**2.0 L engine models**

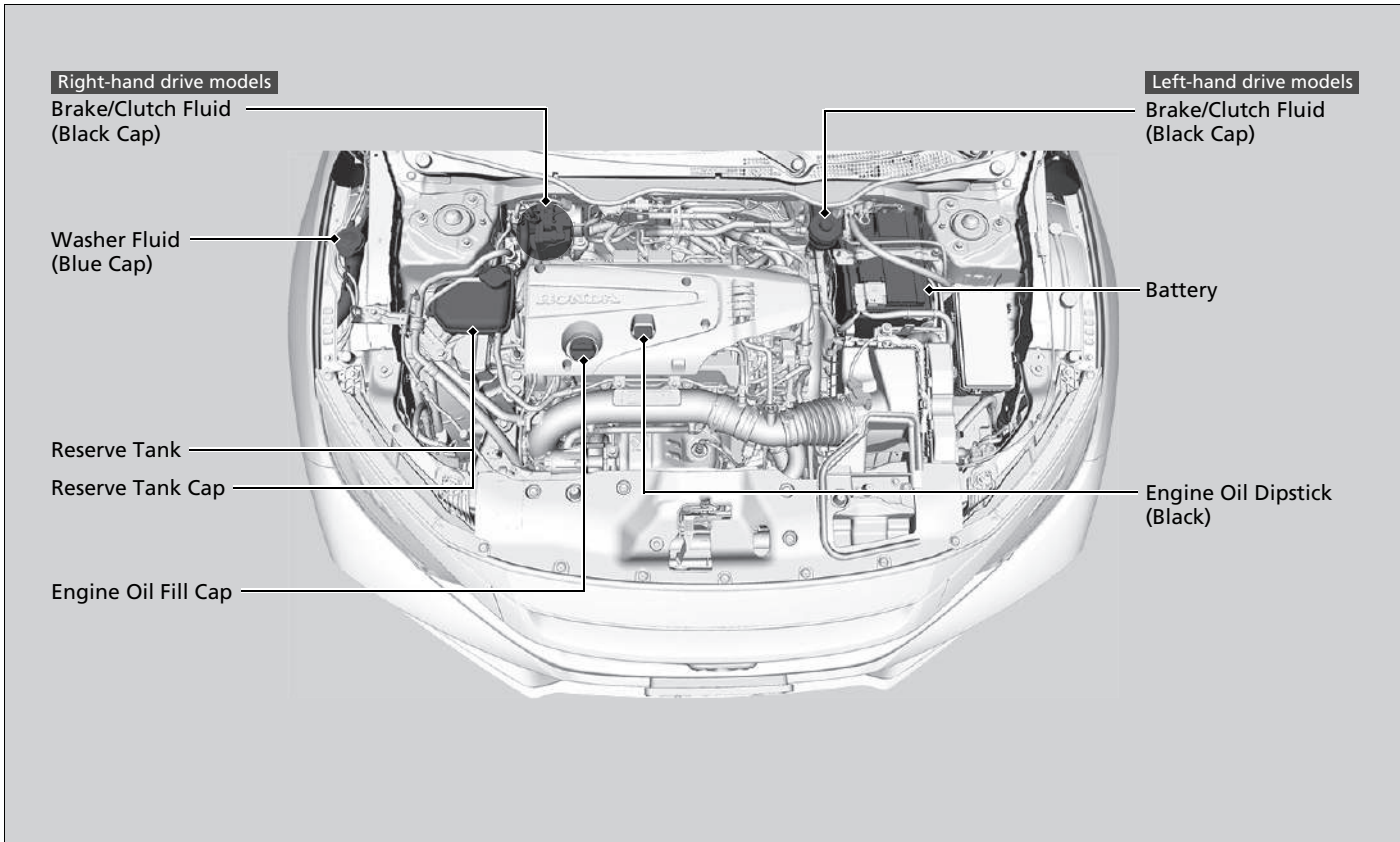

## Opening the Bonnet

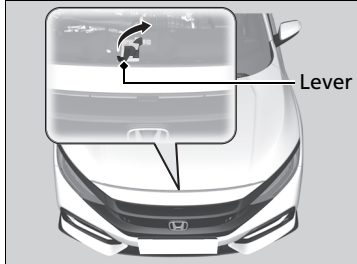
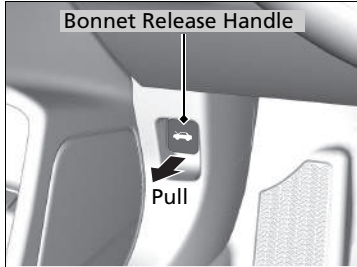

1. Park the vehicle on a level surface, and set the parking brake.
2. Pull the bonnet release handle under the driver's side lower outside corner of the dashboard.
  - The bonnet will pop up slightly.
3. Pull up the bonnet latch lever (located under the front edge of the bonnet to the centre) and raise the bonnet. Once you have raised the bonnet slightly, you can release the lever.

### ►► Opening the Bonnet

#### **⚠ WARNING**

The bonnet support rod can become very hot due to heat from the engine.

To ensure against possible burns, do not handle the metal section of the rod: Use the foam grip instead.

#### **NOTICE**

Do not open the bonnet when the wiper arms are raised. The bonnet will strike the wipers, resulting in possible damage to the bonnet and/or the wipers.

#### **NOTICE**

Do not press the engine cover\* forcibly. This may damage the engine cover and component parts.

When closing the bonnet, check that the bonnet is securely latched.

If the bonnet latch lever moves stiffly, or if you can open the bonnet without lifting the lever, the latch mechanism should be cleaned and lubricated.

#### **Models with Auto Idle Stop**

Do not open the bonnet while the Auto Idle Stop function is activated.

\* Not available on all models

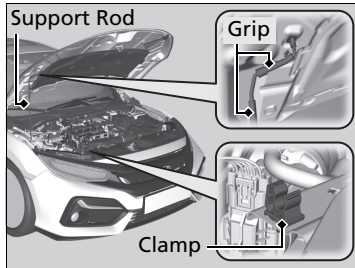

4. Remove the support rod from the clamp using the grip. Mount the support rod in the bonnet.

When closing, remove the support rod, and stow it in the clamp, then gently lower the bonnet. Remove your hand at a height of approximately 30 cm and let the bonnet close.

#### ✕ Opening the Bonnet

##### Models with rear fog light

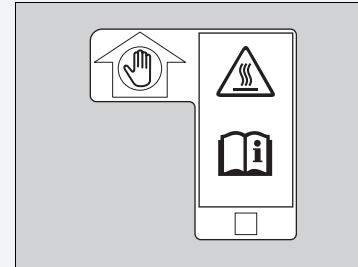

- Grab the foam.
- The support rod gets very hot.
- Refer to the owner's manual.

## Recommended Engine Oil

Use a genuine engine oil or another commercial engine oil of suitable type and viscosity (for the ambient temperature) as shown in the image that follows.

Oil is a major contributor to your engine's performance and longevity. If you drive the vehicle with insufficient or deteriorated oil, the engine may fail or be damaged.

See the engine oil fill cap markings in the image that follows and on the actual cap to check if the vehicle is equipped with a gasoline particulate filter\*.

➤ **Adding Engine Oil** P. 693

### ► Recommended Engine Oil

#### Engine Oil Additives

##### Models with gasoline particulate filter

You cannot use Engine Oil Additives.

##### Models without gasoline particulate filter

Your vehicle does not require oil additives. In fact, they may adversely affect the engine performance and durability.

\* Not available on all models

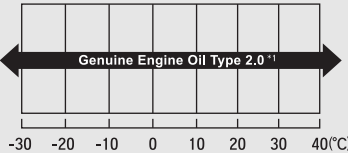
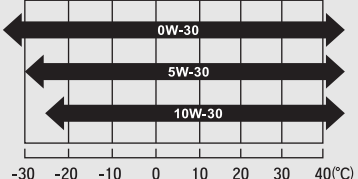

European and Ukrainian Models

Model	Engine Oil Fill Cap Markings	Genuine Engine Oil	Commercial Engine Oil
With Gasoline Particulate Filter		<ul style="list-style-type: none"> <li>• Honda Genuine Engine Oil Type 2.0*1</li> </ul>  <p>Ambient Temperature</p>	<ul style="list-style-type: none"> <li>• ACEA C2/C3</li> </ul>  <p>Ambient Temperature</p>

\*1: Formulated to improve fuel economy.

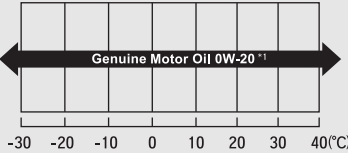
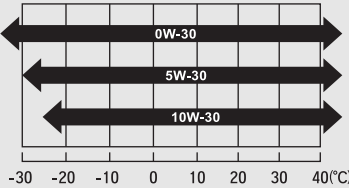

Except European and Ukrainian models

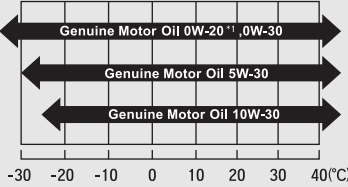
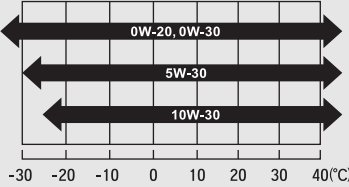
Model	Engine Oil Fill Cap Markings	Genuine Engine Oil	Commercial Engine Oil
With Gasoline Particulate Filter		<ul style="list-style-type: none"> <li>• Honda Genuine Motor Oil</li> </ul>  <p>Ambient Temperature</p>	<ul style="list-style-type: none"> <li>• ACEA C2/C3</li> </ul>  <p>Ambient Temperature</p>
Without Gasoline Particulate Filter		<ul style="list-style-type: none"> <li>• Honda Genuine Motor Oil</li> </ul>  <p>Ambient Temperature</p>	<ul style="list-style-type: none"> <li>• API service SM or higher grade fuel-efficient oil</li> <li>• ACEA A5/B5</li> </ul>  <p>Ambient Temperature</p>

\*1: Formulated to improve fuel economy.

## Oil Check

We recommend that you check the engine oil level every time you refuel.

Park the vehicle on level ground.

Wait approximately three minutes after turning the engine off before you check the oil.

### Oil Check

If the oil level is near or below the lower mark, slowly add oil, being careful not to overfill.

The amount of oil consumed depends on how the vehicle is driven and the climatic and road conditions encountered. The rate of oil consumption can be up to 1 litre per 1,000 km/625 miles.

Consumption is likely to be higher when the engine is new.

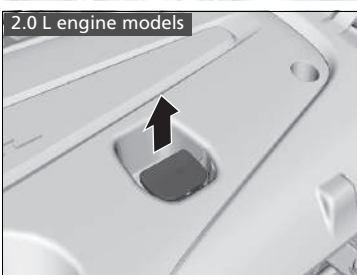
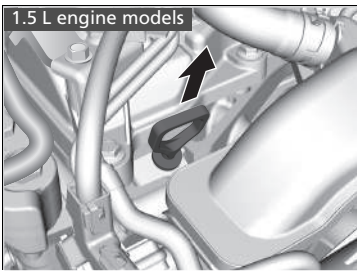
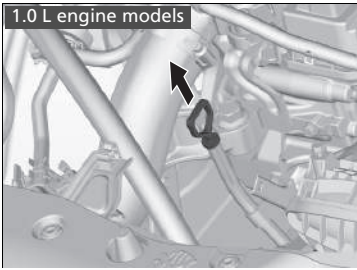

1. Remove the dipstick (orange or black).
2. Wipe the dipstick with a clean cloth or paper towel.
3. Insert the dipstick back all the way into its hole.

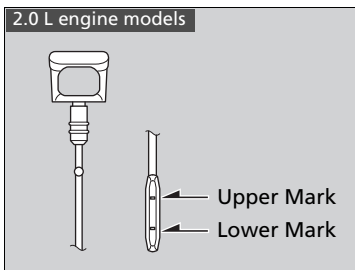
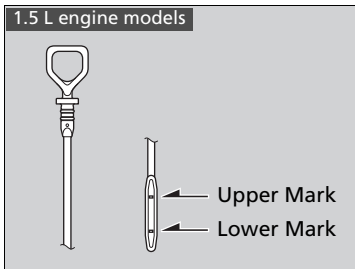
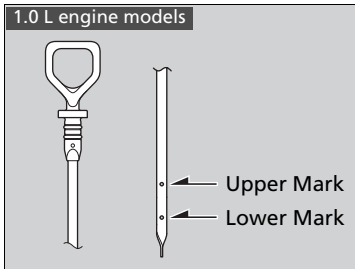

4. Remove the dipstick again, and check the level. It should be between the upper and lower marks. Add oil if necessary.

## Adding Engine Oil

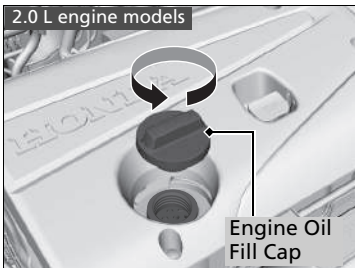
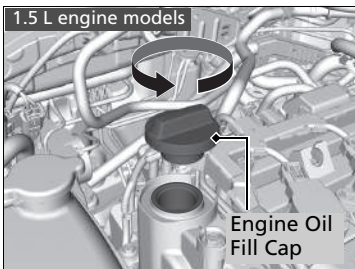
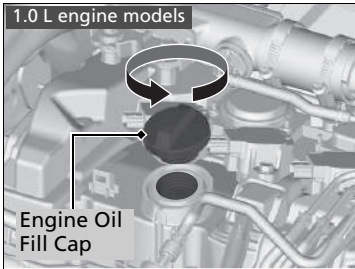

1. Unscrew and remove the engine oil fill cap.
2. Add oil slowly.
3. Reinstall the engine oil fill cap, and tighten it securely.
4. Wait for three minutes and recheck the engine oil dipstick.

### ►► Adding Engine Oil

#### NOTICE

Do not fill the engine oil above the upper mark. Overfilling the engine oil may result in leaks and engine damage.

If any oil spills, wipe it away immediately. Spilled oil may damage the engine compartment components.

## Engine Coolant

### Specified coolant: Honda All Season Antifreeze/Coolant Type 2

This coolant is premixed with 50% antifreeze and 50% water. Do not add any straight antifreeze or water.

We recommend you check the engine coolant level every time you refuel. Check the reserve tank. Add the engine coolant accordingly.

### Engine Coolant

#### **WARNING**

Removing the reserve tank cap while the engine is hot can cause the coolant to spray out, seriously scalding you.

Always let the engine and radiator cool down before removing the reserve tank cap.

If temperatures consistently below  $-30^{\circ}\text{C}$  are expected, the coolant mixture should be changed to a higher concentration. Consult your Honda dealer for details about a suitable coolant mixture.

If Honda antifreeze/coolant is not available, you may use another major brand of non-silicate coolant as a temporary replacement. Check that it is a high quality coolant recommended for aluminium engines. Continued use of any non-Honda coolant can result in corrosion, causing the cooling system to malfunction or fail. Have the cooling system flushed and refilled with Honda antifreeze/coolant as soon as possible.

Do not add rust inhibitors or other additives to your vehicle's cooling system. They may not be compatible with the coolant or with the engine components.

## ■ Checking the Coolant

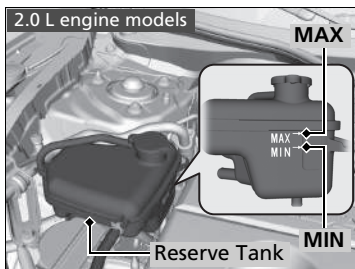
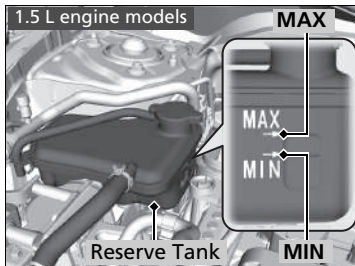
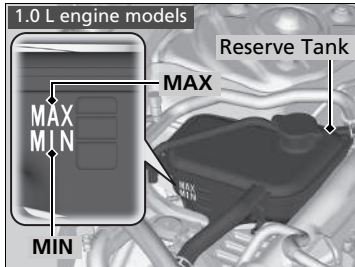

1. **Make sure the engine and radiator are cool.**
2. Check the amount of coolant in the reserve tank.
  - If the coolant level is below the **MIN** mark, add the specified coolant until it reaches the **MAX** mark.
3. Inspect the cooling system for leaks.

## Adding the Coolant

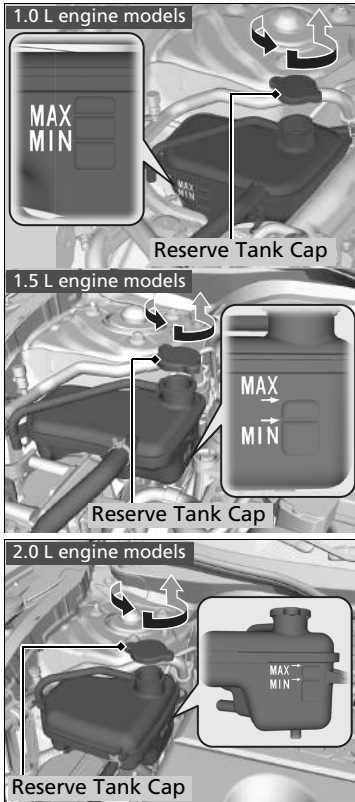

1. **Make sure the engine and radiator are cool.**
2. Turn the reserve tank cap 1/8 turn anticlockwise and relieve any pressure in the cooling system.
3. Push down and turn the reserve tank cap anticlockwise to remove it.
4. Pour coolant into the reserve tank until it reaches the **MAX** mark.
5. Put the reserve tank cap back on, and tighten it fully.

## Adding the Coolant

### NOTICE

Pour the fluid slowly and carefully so you do not spill any. Clean up any spills immediately; they can damage components in the engine compartment.



## ■ Engine Coolant Reserve Tank Cap

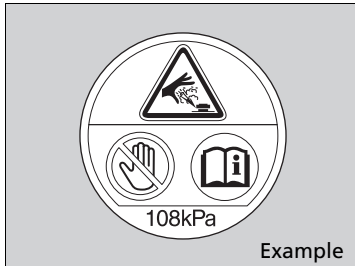

- Never open when hot.
- Hot coolant will scald you.

### Except 2.0 L engine models

- Relief pressure valve begins to open at 108 kPa.

### 2.0 L engine models

- Relief pressure valve begins to open at 127 kPa.

## Transmission Fluid

### Continuously variable transmission models

#### Continuously Variable Transmission (CVT) Fluid

##### Specified fluid: Honda HCF-2

Have a dealer check the fluid level and replace if necessary. Follow your vehicle's maintenance service timing of when to change continuously variable transmission fluid.

🔧 **Maintenance Schedule** \* P. 674

Do not attempt to check or change the continuously variable transmission fluid yourself.

### Manual transmission models

#### Manual Transmission Fluid

##### Specified fluid: Honda MTF

Have a dealer check the fluid level and replace if necessary. Follow your vehicle's maintenance service timing of when to change manual transmission fluid.

🔧 **Maintenance Schedule** \* P. 674

Do not attempt to check or change the manual transmission fluid yourself.

#### Continuously Variable Transmission (CVT) Fluid

##### NOTICE

**Do not mix Honda HCF-2 with other transmission fluids.**

Using a transmission fluid other than Honda HCF-2 may adversely affect the operation and durability of your vehicle's transmission, and damage the transmission.

Any damage caused by using a transmission fluid that is not equivalent to Honda HCF-2 is not covered by Honda's new vehicle limited warranty.

#### Manual Transmission Fluid

##### NOTICE

If Honda MTF is not available, you may use the API certificated SAE 0W-20 or 5W-20 viscosity motor oil as a temporary measure.

Replace with MTF as soon as possible. Motor oil does not contain the proper additives for the transmission and continued use can cause decreased shifting performance and lead to transmission damage.

## Brake/Clutch \* Fluid

**Specified fluid: Brake Fluid with DOT 3 or DOT 4**

Use the same fluid for both the brakes and clutch\*.

### » Brake/Clutch \* Fluid

#### NOTICE

Brake fluid marked DOT 5 is not compatible with your vehicle's braking system and can cause extensive damage.

We recommend using a genuine product.

If the brake fluid level is at or below the **MIN** mark, have a dealer inspect the vehicle for leaks or worn brake pads as soon as possible.

\* Not available on all models

## Checking the Brake Fluid

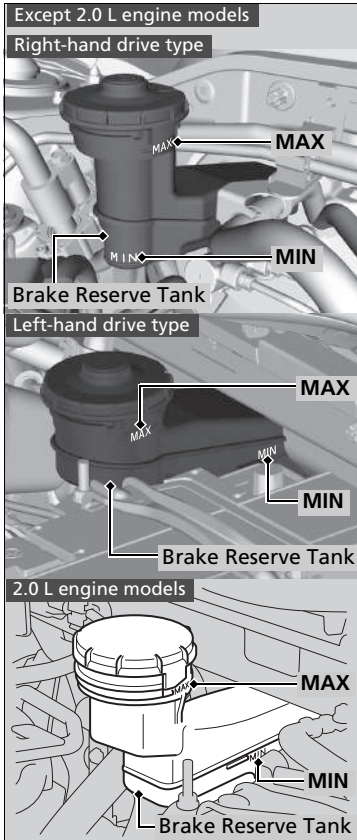

The fluid level should be between the **MIN** and **MAX** marks on the side of the reserve tank.

### Manual transmission models

The brake fluid reserve tank is also used for your vehicle's clutch fluid. As long as you keep the brake fluid level as instructed above, there is no need for checking the clutch fluid level.

## Refilling Window Washer Fluid

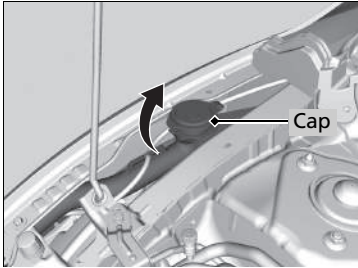

### Models with headlight washers

If the washer fluid is low, a symbol appears on the driver information interface.

### Models without headlight washers

Open the cap and check the amount of window washer fluid.

If the level is low, fill the washer reservoir.

Pour the washer fluid carefully. Do not overflow the reservoir.

## Fuel Filter

Replace the fuel filter according to the time and distance recommendations in the maintenance schedule.

### South African and Ukrainian models

It is recommended to replace the fuel filter every 45,000 km, or 3 years, if you suspect the fuel you are using is contaminated. In a dusty environment, the filter may become clogged sooner.

### Except European and South African models

It is recommended to replace the fuel filter every 40,000 km (25,000 miles), or 2 years, if you suspect the fuel you are using is contaminated. In a dusty environment, the filter may become clogged sooner.

Have a qualified technician change the fuel filter. Fuel in the system can spray out and create a hazard if all fuel line connections are not handled correctly.

### »» Refilling Window Washer Fluid

#### NOTICE

Do not use engine antifreeze or a vinegar/water solution in the windscreen washer reservoir. Antifreeze can damage your vehicle's paint. A vinegar/water solution can damage the windscreen washer pump. Use only commercially available windscreen washer fluid. Avoid prolonged use of hard water to prevent lime scale build up.

### »» Fuel Filter

#### Models with service reminder system

The fuel filter should be replaced according to the service reminder indication.

# Replacing Light Bulbs

## Headlights

Headlights are LED type. Have an authorised Honda dealer inspect and replace the light assembly.

## Front Turn Signal, Position/Daytime Running Lights

Front turn signal, position/daytime running lights are LED type. Have an authorised Honda dealer inspect and replace the light assembly.

## Front Fog Lights \*

Front fog lights are LED type. Have an authorised Honda dealer inspect and replace the light assembly.

### Headlights

The headlight aim is set by the factory, and does not need to be adjusted. However, if you regularly carry heavy items in the luggage area or tow a trailer\*, have the aiming readjusted at a dealer or by a qualified technician.

## Side Marker Light Bulbs\*

When replacing, use the following bulbs.

**Side Marker Light: 5 W (Amber)**

Except 2.0 L engine models

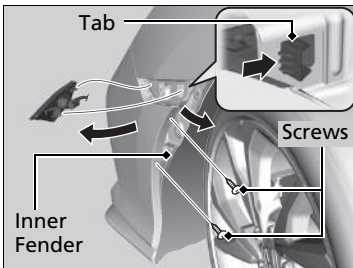

1. Remove the screws, and pull the inner fender back.
2. Push the tab to remove the light assembly.

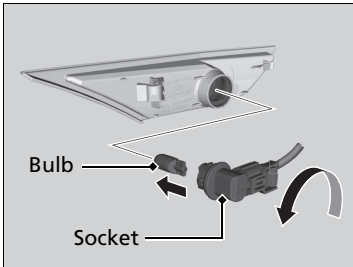

3. Turn the socket anticlockwise to remove it, then remove the old bulb.
4. Insert a new bulb.

\* Not available on all models

2.0 L engine models

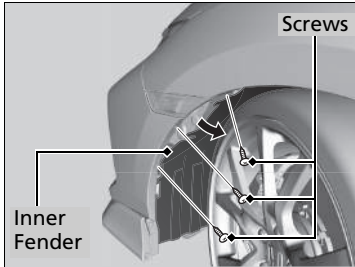

1. Turn the steering wheel all the way to the opposite side from the light being replaced.  
Right side: Turn the steering wheel anticlockwise.  
Left side: Turn the steering wheel clockwise.
2. Remove the screws, and pull the inner fender back.
3. Turn the socket anticlockwise to remove it, then remove the old bulb.
4. Insert a new bulb.

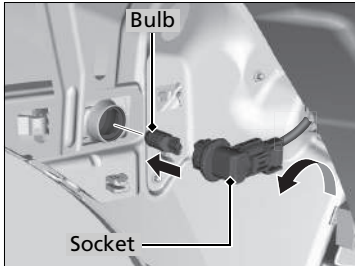



## Side Turn Signal/Emergency Indicator Lights

Door mirror type

### Side Turn Signal/Emergency Indicator Light: LED type

Side turn signal lights are LED type. Have an authorised Honda dealer inspect and replace the light assembly.

Fender type

### Side Turn Signal/Emergency Indicator Light: 5 W (Amber)

Side turn signal lights bulbs and front side marker light bulbs are the same.

➤ **Side Marker Light Bulbs**\* P. 703

\* Not available on all models

## Brake Light, Rear Turn Signal Light and Back-Up Light Bulbs

When replacing, use the following bulbs.

**Brake Light: 21 W**  
**Rear Turn Signal Light: 21 W (Amber)**  
**Back-Up Light: 16 W**

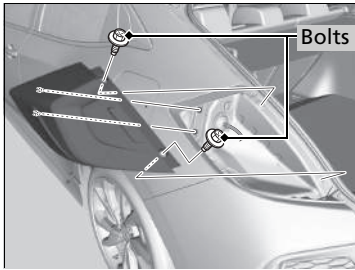

1. Use a Phillips-head screwdriver or socket to remove the bolts.
2. Pull the light assembly out of the rear pillar.

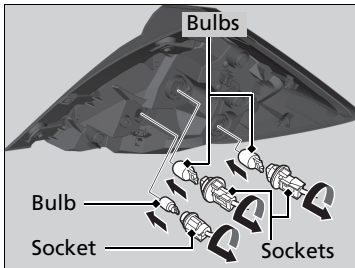

3. Turn the socket anticlockwise and remove it.
4. Remove the old bulb and insert a new bulb.
5. Slide the light assembly onto the guide on the body.
6. Align the pins with the body grommets, then push in until they fully seat.

## **Taillights and Rear Fog Light\***

---

Taillights and rear fog light are LED type. Have an authorised Honda dealer inspect and replace the light assembly.

## **Taillights**

---

Taillights are LED type. Have an authorised Honda dealer inspect and replace the light assembly.

## **Rear Licence Plate Light**

---

Rear licence plate light is LED type. Have an authorised Honda dealer inspect and replace the light assembly.

## **High-Mount Brake Light**

---

High-mount brake light is LED type. Have an authorised Honda dealer inspect and replace the light assembly.

\* Not available on all models

## Other Light Bulbs

### Map Light Bulbs

Models with sunroof switch or ambient light

When replacing, use the following bulbs.

**Map Light: 8 W**

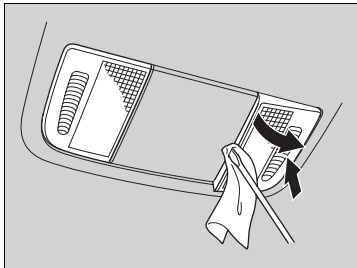

1. Push on the lens of the opposite side you are replacing.
2. Pry on the edge of the cover using a flat-tip screwdriver to remove the cover.
  - Wrap the flat-tip screwdriver with a cloth to prevent scratches.

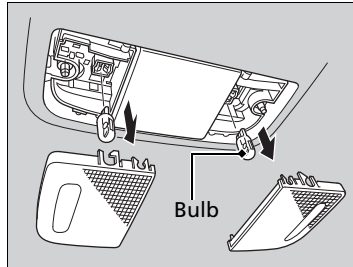

3. Remove the old bulb and insert a new bulb.

Models without sunroof switch or ambient light

When replacing, use the following bulbs.

**Map Light: 8 W**

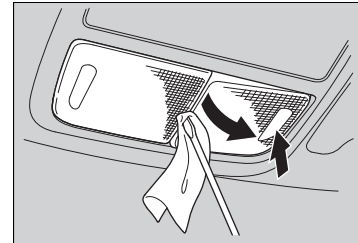

1. Push on the lens of the opposite side you are replacing.
2. Pry on the edge between the lenses using a flat-tip screwdriver to remove the cover.
  - Wrap the flat-tip screwdriver with a cloth to prevent scratches.

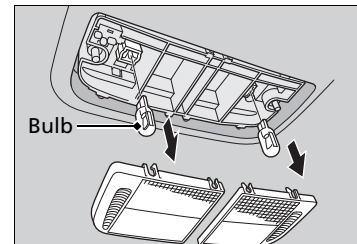

3. Remove the old bulb and insert a new bulb.

### ■ Ceiling Light Bulb

When replacing, use the following bulb.

**Ceiling Light: 8 W**

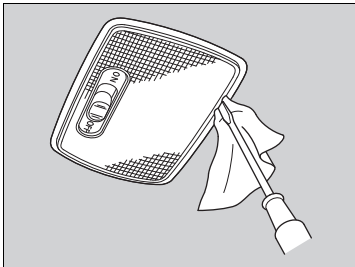

1. Pry on the edge of the cover using a flat-tip screwdriver to remove the cover.
  - Wrap the flat-tip screwdriver with a cloth to prevent scratches.

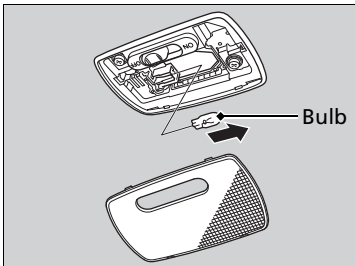

2. Remove the old bulb and insert a new bulb.

\* Not available on all models

### ■ Vanity Mirror Light Bulbs\*

When replacing, use the following bulbs.

**Vanity Mirror Light: 2 W**

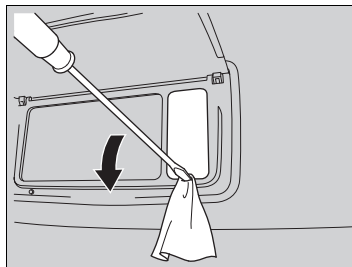

1. Pry on the edge of the cover using a flat-tip screwdriver to remove the cover.
  - Wrap the flat-tip screwdriver with a cloth to prevent scratches.

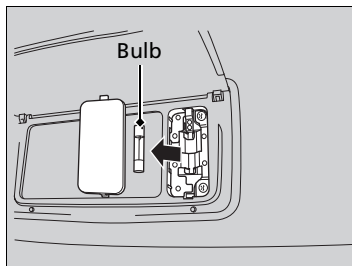

2. Remove the old bulb and insert a new bulb.

### ■ Glove Box Light Bulb\*

When replacing, use the following bulb.

**Glove Box Light: 3.4 W**

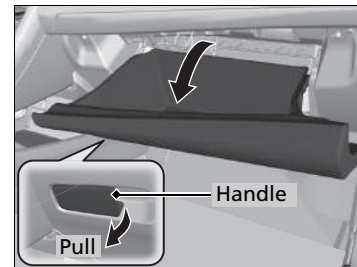

1. Open the glove box.

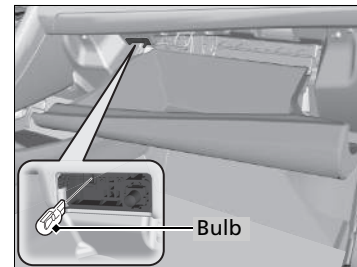

2. Remove the old bulb and insert a new bulb.

### ■ Luggage Area Light Bulb

When replacing, use the following bulb.

**Luggage Area Light: 5 W**

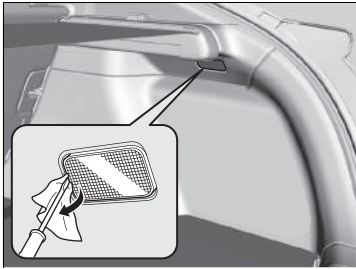

1. Pry on the edge of the cover using a flat-tip screwdriver to remove the cover.
  - Wrap the flat-tip screwdriver with a cloth to prevent scratches.

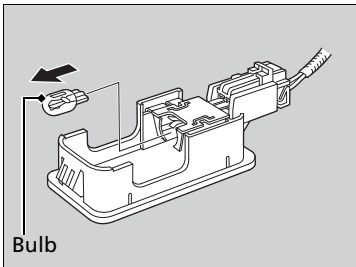

2. Remove the old bulb and insert a new bulb.

# Checking and Maintaining Wiper Blades

## Checking Wiper Blades

If the wiper blade rubber has deteriorated, it will leave streaks and the hard surfaces of the blade may scratch the window glass.

## Changing the Front Wiper Blade Rubber

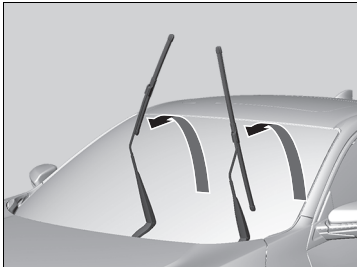
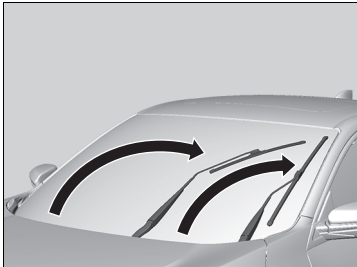

1. Turn the ignition switch to LOCK [0]\*1.
2. While holding the wiper switch in the **MIST** position, turn the ignition switch to ON [II]\*1, then to LOCK [0]\*1.
  - ▶ Both wiper arms are set to the maintenance position as shown in the image.
3. Lift both wiper arms.

\*1: Models with the keyless access system have an **ENGINE START/STOP** button instead of an ignition switch.

### Changing the Front Wiper Blade Rubber

#### NOTICE

Avoid dropping the wiper arm onto the windshield, it may damage the wiper arm and/or the windshield.

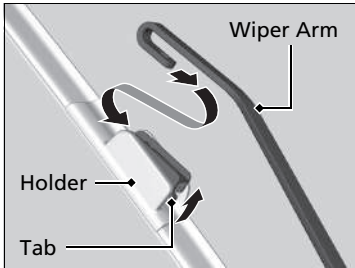

**4.** Press up on and hold the tab, then slide the holder off the wiper arm.

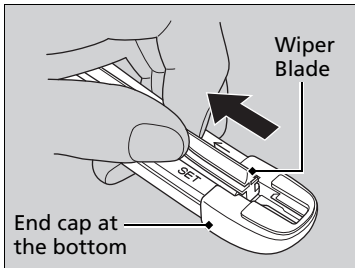

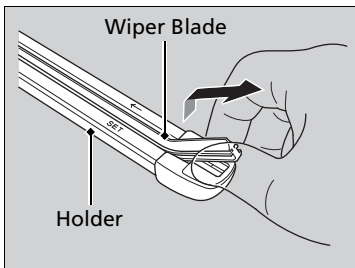

**5.** Pull the end of the wiper blade in the direction of the arrow in the image until it is out of the holder's end cap.



**6.** Pull the wiper blade in the opposite direction to slide it out of the holder.

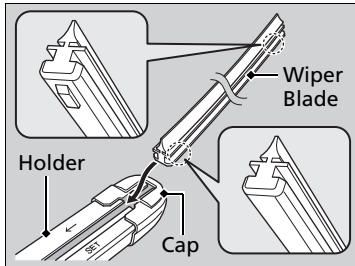



7. Insert the flat side of the new wiper blade onto the bottom part of the holder. Insert the blade all the way.
8. Install the end of the wiper blade into the cap.
9. Slide the holder onto the wiper arm until it locks.
10. Lower both wiper arms.
11. Turn the ignition switch to ON \*1 and hold the wiper switch in the **MIST** position until both wiper arms return to the standard position.

\*1: Models with the keyless access system have an **ENGINE START/STOP** button instead of an ignition switch.

## Changing the Rear Wiper Blade Rubber\*

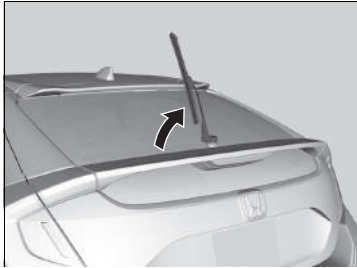

1. Raise the wiper arm off.

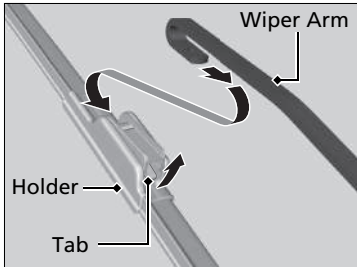

2. Press up on and hold the tab, then slide the holder off the wiper arm.

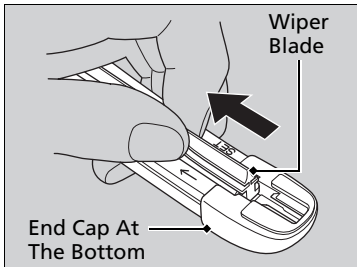

3. Pull the end of the wiper blade in the direction of the arrow in the image until it is out of the holder's end cap.

### Changing the Rear Wiper Blade Rubber\*

#### NOTICE

Avoid dropping the wiper arm; it may damage the rear window.

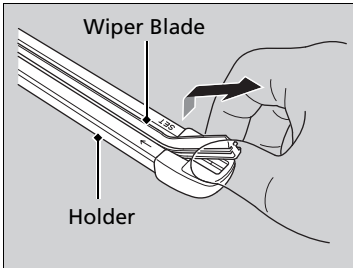

4. Pull the wiper blade in the opposite direction to slide it out of holder.

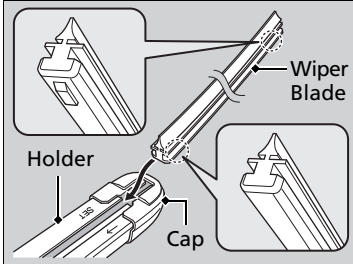

5. Insert the flat side of the new wiper blade onto the bottom part of the holder. Insert the blade all the way.
6. Install the end of the wiper blade into the cap.
7. Slide the holder onto the wiper arm until it locks.
8. Lower the wiper arm.

# Checking and Maintaining Tyres

## Checking Tyres

To safely operate your vehicle, your tyres must be of the proper type and size, in good condition with adequate tread, and properly inflated.

### ■ Inflation guidelines

Properly inflated tyres provide the best combination of handling, tread life, and comfort. Refer to the driver's doorjamb label for the specified pressure.

Underinflated tyres wear unevenly, adversely affect handling and fuel economy, and are more likely to fail from overheating.

Overinflated tyres make your vehicle ride harshly, are more prone to road hazards, and wear unevenly.

Every day before you drive, look at each of the tyres. If one looks lower than the others, check the pressure with a tyre gauge.

At least once a month or before long trips, use a gauge to measure the pressure in all tyres, including the spare\*. Even tyres in good condition can lose 10–20 kPa (0.1–0.2 bar, 1–2 psi) per month.

### ■ Inspection guidelines

Every time you check inflation, also examine the tyres and valve stems.

Look for:

- Bumps or bulges on the side or in the tread. Replace the tyre if you find any cuts, splits, or cracks in the side of the tyre. Replace it if you see fabric or cord.
- Remove any foreign objects and inspect for air leaks.
- Uneven tread wear. Have a dealer check the wheel alignment.
- Excessive tread wear.
  - ▣ **Wear Indicators** P. 717
- Cracks or other damage around valve stem.

\* Not available on all models

### ▣ Checking Tyres

## ⚠ WARNING

Using tyres that are excessively worn or improperly inflated can cause a crash in which you can be seriously hurt or killed.

Follow all instructions in this owner's manual regarding tyre inflation and maintenance.

Measure the air pressure when tyres are cold. This means the vehicle has been parked for at least three hours, or driven less than 1.6 km (1 mile). If necessary, add or release air until the specified pressure is reached.

If checked when hot, tyre pressure can be as much as 30–40 kPa (0.3–0.4 bar, 4–6 psi) higher than if checked when cold.

Whenever tyre pressure is adjusted, you must calibrate the deflation warning system.

▣ **Deflation Warning System** P. 549

Have a dealer check the tyres if you feel a consistent vibration while driving. New tyres and any that have been removed and reinstalled should be properly balanced.

## Wear Indicators

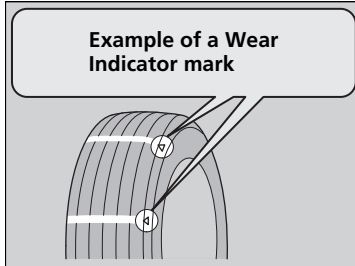

The groove where the wear indicator is located is 1.6 mm (1/16 inch) shallower than elsewhere on the tyre. If the tread has worn so that the indicator is exposed, replace the tyre.

**Worn out tyres have poor traction on wet roads.**

## Tyre Service Life

The life of your tyres is dependent on many factors, including driving habits, road conditions, vehicle loading, inflation pressure, maintenance history, speed, and environmental conditions (even when the tyres are not in use).

In addition to regular inspections and inflation pressure maintenance, it is recommended that you have annual inspections performed once the tyres reach five years old. All tyres, including the spare\*, should be removed from service after 10 years from the date of manufacture, regardless of their condition or state of wear.

\* Not available on all models

### Checking Tyres

#### 2.0 L engine models

#### High speed driving

We recommend that you do not drive faster than the posted speed limits and conditions allow. If you drive at sustained high speeds (over 220 km/h or 112 mph), adjust the cold tyre pressures as shown below to avoid excessive heat build up and sudden tyre failure.

Tyre Size 245/30ZR20 90Y	
Number of occupants	Pressure
1	Front: 280 kPa (2.8 bar, 41 psi)
2	Rear: 230 kPa (2.3 bar, 33 psi)
3	Front: 290 kPa (2.9 bar, 42 psi)
4	Rear: 250 kPa (2.5 bar, 36 psi)

#### Models with FORGED engraved on the wheel

This vehicle is equipped with high grip tyres. Due to their focus on dry-grip performance, these tyres have shallower tread grooves and wear faster than ordinary commercial tyres. Periodically check the tread depth. Drive at a safe speed in the rain and on wet roads.

## Tyre and Wheel Replacement

Replace your tyres with radials of the same size, load range, speed rating, and maximum cold tyre pressure rating (as shown on the tyre's sidewall). Using tyres of a different size or construction can cause certain vehicle systems such as the ABS and Vehicle Stability Assist (VSA) system to work incorrectly.

It is best to replace all four tyres at the same time. If that isn't possible, replace the front or rear tyres in pairs.

Make sure that the wheel's specifications match those of the original wheels.

### ✕ Tyre and Wheel Replacement

#### **⚠ WARNING**

Installing improper tyres on your vehicle can affect handling and stability. This can cause a crash in which you can be seriously hurt or killed.

Always use the size and type of tyres recommended in the tyre information label on your vehicle.

## Tyre Rotation

Rotating tyres according to the maintenance schedule helps to distribute wear more evenly and increase tyre life.

### ■ Tyres without rotation marks

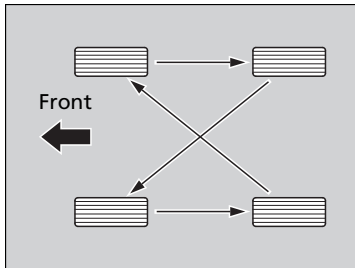

Rotate the tyres as shown here.

### ■ Tyres with rotation marks

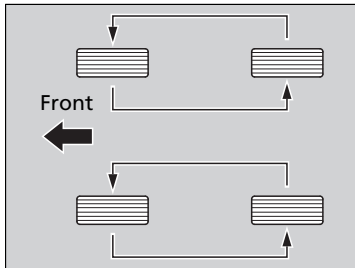

Rotate the tyres as shown here.

### ▣ Tyre Rotation

Tyres with directional tread patterns should only be rotated front to back (not from one side to the other). Directional tyres should be mounted with the rotation indication mark facing forward, as shown below.

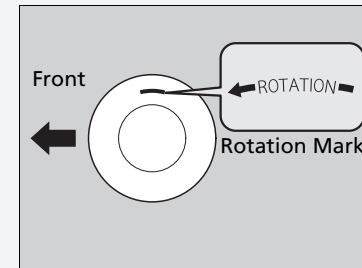

When the tyres are rotated, make sure the air pressures are checked.

Whenever tyres are rotated, you must calibrate the deflation warning system.

▣ **Deflation Warning System** P. 549

## Snow Traction Devices

If driving on snowy or frozen roads, mount winter tyres, or tyre chains; reduce speed; and maintain sufficient distance between vehicles when driving.

Be particularly careful when operating the steering wheel or brakes to prevent skidding.

Use tyre chains, winter tyres, or all season tyres when necessary or according to the law.

When mounting, refer to the following points.

For winter tyres:

- Select the size and load ranges that are the same as the original tyres.
- Mount the tyres to all four wheels.

For tyre chains:

- Consult a dealer before purchasing any type of chains for your vehicle.
- Install them on the front tyres only.
- Because your vehicle has limited tyre clearance, we strongly recommend using the chains listed below:

Original Tyre Size*1	Chain Type
<b>215/55R16 93V</b>	<b>RUD-matic classic 48489</b>
<b>235/45R17 94W*2</b>	<b>(Not Available)</b>
<b>245/30ZR20 90Y*3</b>	<b>(Not Available)</b>
<b>235/40R18 95Y</b>	<b>SCC Auto Truck 0154705</b>

\*1: Original tyre size is mentioned on the tyre information label on the driver's doorjamb.

\*2: You cannot mount chains on this tyre. If you have to use tyre chains, replace the tyres with the original 215/55R16 size tyres.

\*3: You cannot mount chains on this tyre. If you have to use tyre chains, replace the tyres with the original 235/40R18 size tyres.

### ❏ Snow Traction Devices

## ⚠ WARNING

Using the wrong chains, or not properly installing chains, can damage the brake lines and cause a crash in which you can be seriously injured or killed.

Follow all instructions in this owner's manual regarding the selection and use of tyre chains.

### NOTICE

Traction devices that are the wrong size or improperly installed can damage your vehicle's brake lines, suspension, body, and wheels. Stop driving if they are hitting any part of the vehicle.

According to the EU legislation for tyres, when winter tyres are used, it is necessary to affix a sticker with the allowable max. speed of the winter tyres clearly in the field of view of the driver, if the designed max. speed of vehicle is higher than the allowed max. speed of winter tyre. A sticker is obtainable from your tyre dealer. If you have any question, consult a dealer.

When tyre chains are mounted, follow the chain manufacturer's instructions regarding vehicle operational limits.



- Follow the chain manufacturer's instruction when installing. Mount them as tightly as you can.
- Check that the chains do not touch the brake lines or suspension.
- Drive slowly.

#### ▣ Snow Traction Devices

Use tyre chains only in an emergency or when they are legally required for driving through a certain area.

Use greater caution when driving with tyre chains on snow or ice. They may have less-predictable handling than good winter tyres without chains.

If your vehicle is equipped with summer, high grip<sup>\*1</sup> or ultra high performance<sup>\*2</sup> tyres, be aware that these tyres are not designed for winter driving conditions. For more information, contact a dealer.

\*1: Models with FORGED engraved on the wheel

\*2: 2.0 L engine models without FORGED engraved on the wheel

#### ▣ 2.0 L engine models

This vehicle is originally equipped with high grip tyres<sup>\*1</sup> or high performance tyres<sup>\*2</sup>. If exposed to temperatures below approximately 7°C, the tyres will not be able to perform at their full potential.

Do not use the high performance tyres if ambient temperatures are below -10°C<sup>\*1</sup> or -20°C<sup>\*2</sup>: The tyres can become brittle and, as a result, may suffer from surface cracking.

\*1: Models with FORGED engraved on the wheel

\*2: Models without FORGED engraved on the wheel

# Battery

## Checking the Battery

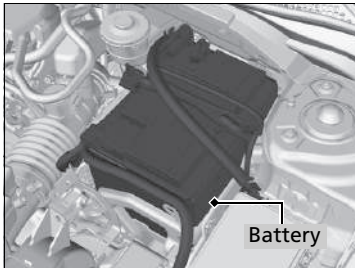

The condition of the battery is monitored by a sensor located on the negative terminal of the battery. If there is a problem with this sensor, the driver information interface will display a warning message. If this happens, have your vehicle inspected by a dealer.

Check the battery terminals for corrosion monthly.

If your vehicle's battery is disconnected or goes dead:

- The audio system\* is disabled.
  - **Reactivating the audio system** P. 287
- The clock resets.
  - **Clock** P. 186
- The immobilizer system\* needs to be reset.
  - **Immobilizer System Indicator** P. 122

### ⚠ Battery

#### ⚠ WARNING

The battery gives off explosive hydrogen gas during normal operation.

A spark or open flame can cause the battery to explode with enough force to kill or seriously hurt you.

Keep all sparks, open flames, and smoking materials away from the battery.

Wear protective clothing and a face shield, or have a skilled technician do any battery maintenance.

#### ⚠ WARNING

The battery contains sulfuric acid (electrolyte) which is highly corrosive and poisonous.

Getting electrolyte in your eyes or on your skin can cause serious burns. Wear protective clothing and eye protection when working on or near the battery.

Swallowing electrolyte can cause fatal poisoning if immediate action is not taken.

**KEEP OUT OF THE REACH OF CHILDREN**

## Charging the Battery

Disconnect both battery cables to prevent damaging your vehicle's electrical system. Always disconnect the negative (-) cable first, and reconnect it last.

### ⌘ Battery

#### Emergency Procedures

Eyes: Flush with water from a cup or other container for at least 15 minutes. (Water under pressure can damage the eye.) Call a physician immediately.

Skin: Remove contaminated clothing. Flush the skin with large quantities of water. Call a physician immediately.

Swallowing: Drink water or milk. Call a physician immediately.

When you find corrosion, clean the battery terminals by applying a baking powder and water solution. Clean the terminals with a damp towel. Cloth/towel dry the battery. Coat the terminals with grease to help prevent future corrosion.

When replacing the battery, the replacement must be of the same specifications.

Consult a dealer for more information.

#### Models with Auto Idle Stop

The battery installed in this vehicle is specifically designed for a model with Auto Idle Stop.

Using a battery other than this specified type may shorten the battery life, and prevent Auto Idle Stop from activating. If you need to replace the battery, make sure to select the specified type. Ask a dealer for more details.

⌘ Specifications P. 804

European models

## Replacing the Battery

When you remove and replace the battery, always follow the maintenance safety and the warnings for when checking the battery to prevent potential hazards.

🔧 **Maintenance Safety** P. 663

🔧 **Checking the Battery** P. 722

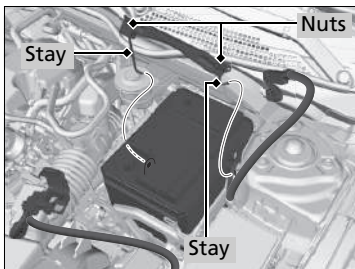
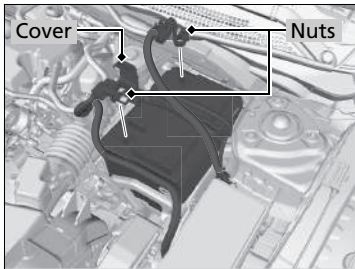

1. Turn the ignition switch to LOCK \*1. Open the bonnet.
2. Loosen the nut on the negative battery cable, then disconnect the cable from the negative (-) terminal.
3. Open the positive battery terminal cover. Loosen the nut on the positive battery cable, then disconnect the cable from the positive (+) terminal.
4. Loosen the nut on each side of the battery bracket with a wrench.
5. Pull the bottom end of each battery stay out of the hole on the battery base, and remove the combination of the battery bracket and the stays.

\* 1: Models with the keyless access system have an **ENGINE START/STOP** button instead of an ignition switch.

\* Not available on all models

### 🔧 Battery

The indicators for the Adaptive Cruise Control (ACC)\*, Adaptive Cruise Control (ACC) with Low Speed Follow\*, road departure mitigation\*, Vehicle Stability Assist (VSA) System, Vehicle Stability Assist (VSA) OFF, low tyre pressure/deflation warning system\*, deflation warning system\* and Collision Mitigation Braking System (CMBS)\* may come on when you turn the ignition switch to ON \*1 after reconnecting a battery. Drive a short distance at more than 20 km/h (12 mph). The indicator should go off. If it does not, have your vehicle checked by a dealer.

### 🔧 Replacing the Battery

#### NOTICE

An improperly disposed of battery can be harmful to the environment and human health. Always confirm local regulations for battery disposal.

This symbol on the battery means that this product must not be treated as household waste.



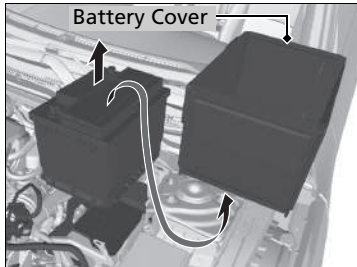

6. Remove the battery cover.
7. Take out the battery carefully.

#### ▣ Replacing the Battery

Always disconnect the negative (-) cable first, and reconnect it last.

To install a new battery, reverse this procedure.

European models

## Battery Label

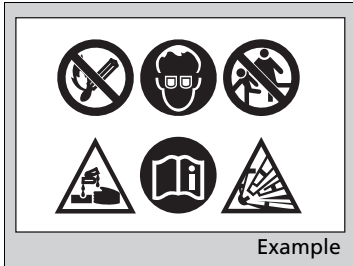

Example

### ☒ Battery Label

#### **DANGER**

- Keep flames and sparks away from the battery. The battery produces explosive gas that can cause an explosion.
- Wear eye protection and rubber gloves when handling the battery to avoid risk of burns or loss of eyesight if exposed to battery electrolyte.
- Do not allow children to handle the battery, under any circumstance. Ensure that anyone handling the battery has a proper understanding of the hazards and correct handling procedures involved.
- Handle battery electrolyte with extreme care, as it contains dilute sulfuric acid. Exposure to eyes or skin can cause burns or loss of eyesight.
- Read this manual carefully, and understand it before handling the battery. Failure to do so can cause personal injury and damage to the vehicle.
- Do not use the battery if the level of electrolyte is at or below the recommended level. Using the battery with low electrolyte can cause it to explode, causing serious injury.

# Remote Transmitter Care

## Replacing the Button Battery

If the indicator does not come on when the button is pressed, replace the battery.

### ■ Retractable Key \*

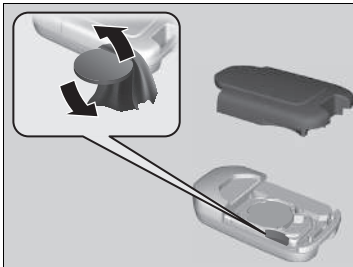

#### Battery type: CR2032

1. Remove the upper half of the cover by carefully prying on the edge with a coin.  
▶ Wrap a coin with a cloth to prevent scratching the retractable key.
2. Remove the button battery with the small flat-tip screwdriver.
3. Make sure to replace the battery with the correct polarity.

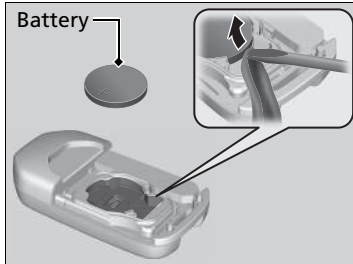

\* Not available on all models

### ▶ Replacing the Button Battery

## ⚠ ⚠ WARNING

### CHEMICAL BURN HAZARD

The battery that powers the remote transmitter can cause severe internal burns and can even lead to death if swallowed. Keep new and used batteries away from children. If you suspect that a child has swallowed the battery, seek medical attention immediately.

A warning mark is located adjacent to the button battery\*.

### NOTICE

An improperly disposed of battery can damage the environment. Always confirm local regulations for battery disposal.

### European models

This symbol on the battery means that this product must not be treated as household waste.



Continued

## ■ Keyless Remote \*



### Battery type: CR2032

1. Remove the built-in key.
2. Remove the upper half by carefully prying on the edge with a coin.
  - ▶ Wrap a coin with a cloth to prevent scratching the keyless remote.
  - ▶ Remove carefully to avoid losing the buttons.
3. Make sure to replace the battery with the correct polarity.

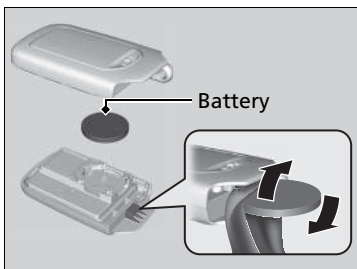

## ▣ Replacing the Button Battery

Replacement batteries are commercially available or at a dealer.



# Heating System\*/Climate Control System\* Maintenance

Models with climate control system and rear fog light

## Air Conditioning

For proper and safe operation of the climate control system, the refrigerant system should only be served by a qualified technician.

Never repair or replace the air conditioning evaporator (cooling coil) with one removed from a used or salvaged vehicle.

### » Air Conditioning

#### NOTICE

Vented refrigerant is harmful to the environment. To avoid refrigerant from venting, never replace the evaporator with one removed from a used or salvaged vehicle.

Refrigerant in your vehicle's air conditioning system is flammable and can be ignited during servicing if proper procedures are not followed.

The air conditioner label is found under the bonnet:



 : Caution

 : Flammable Refrigerant

 : Requires a qualified technician to service

 : Air Conditioning System

\* Not available on all models

## Dust and Pollen Filter

### When to Replace the Dust and Pollen Filter

Replace the dust and pollen filter according to your vehicle's recommended maintenance schedule. It is recommended to replace the filter even sooner if the vehicle has been driven in a dusty environment.

📖 **Maintenance Schedule\*** P. 674

### How to Replace the Dust and Pollen Filter

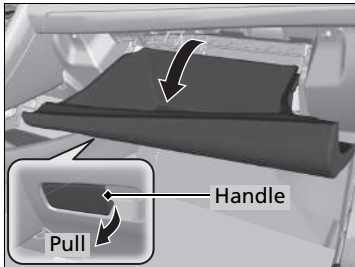

1. Open the glove box.

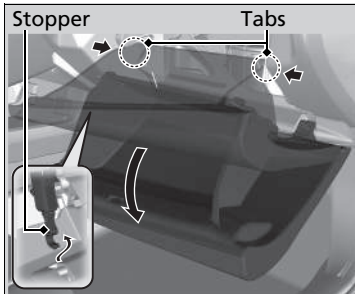

**Models with glove box damper**

2. Push the stopper on the driver's side of the glove box to detach it from the glove box.

**All models**

3. Disengage the two tabs by pushing on each side panel.

4. Pivot the glove box out of the way.

### 📖 Dust and Pollen Filter

If the airflow from the heating system\*/climate control system\* deteriorates noticeably, and the windows fog up easily, the filter may need to be replaced.

The dust and pollen filter collects pollen, dust, and other debris in the air.

If you are not sure how to replace the dust and pollen filter, have it replaced by a dealer.

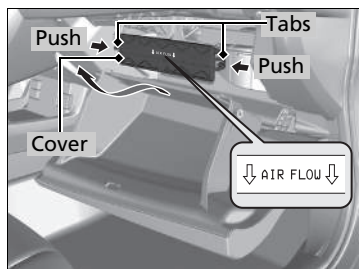

5. Push in the tabs on the corners of the filter case cover, and remove it.

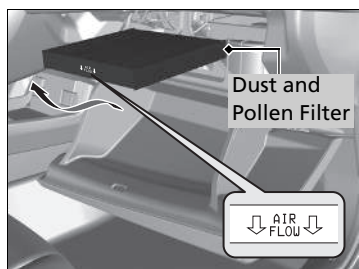

6. Remove the filter from the case.

7. Install a new filter in the case.

► Put the **AIR FLOW** arrow directed side down.

#### ►► Dust and Pollen Filter

##### Models with glove box damper

Installing the dust and pollen filter:

1. Install the filter case cover.
2. Remove the driver's side claw at the bottom of the glove box.
3. Pivot the glove box up into position. Install the tabs back in place.
4. Open the glove box to angle of about 30 °.
5. Install the hook portion of the stopper to the glove box.  
When installing the stopper, put a hand from the bottom of the glove box.
6. Install the claw at bottom of the glove box.

After installing the glove box, open and close several times and make sure the glove box is installed properly.

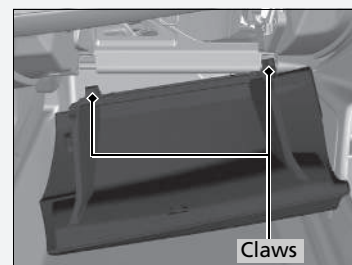

# Cleaning

## Interior Care

Use a vacuum cleaner to remove dust before using a cloth.

Use a damp cloth with a mixture of mild detergent and warm water to remove dirt.

Use a clean cloth to remove detergent residue.

### ■ Cleaning Seat Belts

Use a soft brush with a mixture of mild soap and warm water to clean the seat belts. Let the belts air dry. Wipe the loops of the seat belt anchors using a clean cloth.

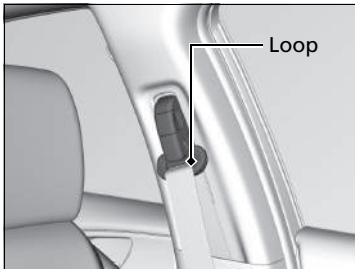

### ▣ Interior Care

Do not spill liquids inside the vehicle.

Electrical devices and systems may malfunction if liquids are splashed on them.

Do not use silicone based sprays on electrical devices such as audio devices and switches.

Doing so may cause the items to malfunction or cause a fire inside the vehicle.

If a silicone based spray is inadvertently used on electrical devices, consult a dealer.

Depending on their composition, chemicals and liquid aromatics may cause discolouration, wrinkles, and cracking to resin-based parts and textiles.

Do not use alkali solvents or organic solvents such as benzene or petrol.

After using chemicals, make sure to gently wipe them away using a dry cloth.

Do not place used cloths on top of resin based parts or textiles for long periods of time without washing.

Be careful not to spill a liquid type air freshener.

## ■ Cleaning the Window

Wipe using a glass cleaner.

## ■ Floor Mats\*

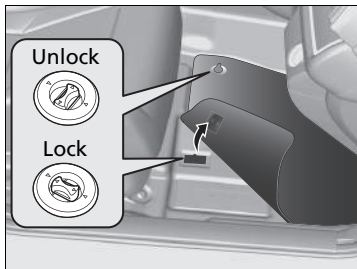

The driver's floor mat hooks over the floor anchors, which keep the mat from sliding forward. To remove a mat for cleaning, turn the anchor knobs to the unlock position. When reinstalling the mat after cleaning, turn the knobs to the lock position.

**Do not put additional floor mats on top of the anchored mat.**

## ■ Maintaining Genuine Leather\*

To properly clean leather:

1. Use a vacuum or soft dry cloth first to remove any dirt or dust.
2. Clean the leather with a soft cloth dampened with a solution comprised of 90% water and 10% neutral soap.
3. Wipe away any soap residue with a clean damp cloth.
4. Wipe away residual water and allow leather to air dry in the shade.

\* Not available on all models

### ►► Cleaning the Window

Wires are mounted to the inside of the rear window. Wipe along the same direction as the wires with a soft cloth so as not to damage them.

Be careful not to spill fluids, such as water or glass cleaner, on or around the cover of both the front sensor camera\* and the rainfall/light sensor\*.

- **Automatic Operation (automatic lighting control)** P. 225
- **Automatic Intermittent Wipers\*** P. 234
- **Front Sensor Camera** P. 630

### ►► Floor Mats\*

If you use any floor mats that were not originally provided with your vehicle, make sure they are designed for your specific vehicle, fit correctly, and are securely anchored by the floor anchors. Position the rear seat floor mats properly. If they are not properly positioned, the floor mats can interfere with the front seat functions.

### ►► Maintaining Genuine Leather\*

It is important to clean or wipe away dirt or dust as soon as possible. Spills can soak into leather resulting in stains. Dirt or dust can cause abrasions in the leather. In addition, please note that some dark coloured clothing can rub onto the leather seats resulting in discolouration or stains.

Continued

### ■ Alcantara® Care \*

After having dusted the material, moisten a soft cloth with clean lukewarm water, wring it dry and blot gently to remove any dirt.  
Once dry, lightly brush with a soft brush.

## Exterior Care

Dust off the vehicle body after you drive. Regularly inspect your vehicle for scratches on painted surfaces. A scratch on a painted surface can result in body rust. If you find a scratch, promptly repair it.

### ■ Washing the Vehicle

Wash the vehicle regularly. Wash more frequently when driving in the following conditions:

- If driving on roads with road salt.
- If driving in coastal areas.
- If tar, soot, bird droppings, insects, or tree sap are stuck to painted surfaces.

### ■ Using an Automated Car Wash

- Make sure to follow the instructions indicated on the automated car wash.
- Fold in the door mirrors.
- For models equipped with automatic intermittent wipers, turn the wipers off.

### ■ Using High Pressure Cleaners

- Keep sufficient distance between the cleaning nozzle and the vehicle body.
- Take particular care around the windows. Standing too close may cause water to enter the vehicle interior.
- Do not spray high pressure water directly into the engine compartment. Instead, use low pressure water and a mild detergent.

\* Not available on all models

### ▶▶ Washing the Vehicle

Do not spray water into the air intake and bonnet intake\* vents. It can cause a malfunction.

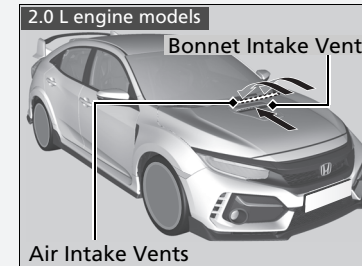
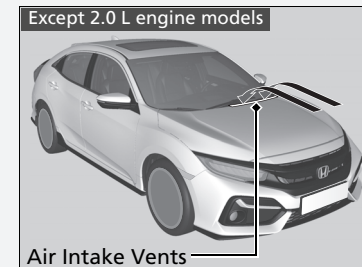

Do not spray water onto the fuel fill door directly. A high-pressure spray may cause it to open.

Continued

## ■ Applying Wax

A good coat of automotive body wax helps to protect your vehicle's paint from the elements. Wax will wear off over time and expose your vehicle's paint to the elements, so reapply as necessary.

## ■ Maintaining the Bumpers and Other Resin Coated Parts

If you get petrol, oil, engine coolant, or battery fluid on resin coated parts, they may be stained or the coating may peel. Promptly wipe it away using a soft cloth and clean water.

## ■ Cleaning the Window

Wipe using a glass cleaner.

## ■ Maintaining Aluminium Wheels\*

Aluminium is susceptible to deterioration caused by salt and other road contaminants. When necessary, as early as possible use a sponge and mild detergent to wipe away these contaminants. Do not use a stiff brush or harsh chemicals (including some commercial wheel cleaners). These can damage the protective finish on aluminium alloy wheels, resulting in corrosion. Depending on the type of finish, the wheels also may lose their luster or appear burnished. To avoid water stains, wipe the wheels dry with a cloth while they are still wet.

## ✎ Washing the Vehicle

Do not spray water onto the capless unit when the fuel fill door is open. It can cause damage to the fuel system or engine.

If you need to lift the wiper arms away from the windscreen, first set the wiper arms to the maintenance position.

✎ **Changing the Front Wiper Blade Rubber**  
P. 711

## ✎ Applying Wax

### NOTICE

Chemical solvents and strong cleaners can damage the paint, metal, and plastic on your vehicle. Wipe away spills immediately.

## ✎ Maintaining the Bumpers and Other Resin Coated Parts

Ask a dealer about the correct coating material when you want to repair the painted surface of the parts made of resin.



### ■ Fogged Exterior Light Lenses

The inside lenses of exterior lights (headlights, brake lights, etc.) may fog temporarily if you have driven in the rain, or after the vehicle has been run through a car wash. Dew condensation also may build up inside the lenses when there is a significant enough difference between the ambient and inside lens temperatures (similar to vehicle windows fogging up in rainy conditions). These conditions are natural processes, not structural design problems in the exterior lights.

Lens design characteristics may result in moisture developing on the light lens frame surfaces. This also is not a malfunction.

However, if you see large amounts of water accumulation, or large water drops building up inside the lenses, have your vehicle inspected by a dealer.

# Accessories and Modifications

## Accessories

When installing accessories, check the following:

- Do not install accessories on the windshield. They can obstruct your view and delay your reaction to driving conditions.
- Do not install any accessories over areas marked SRS Airbag, on the sides or backs of the front seats, on front or side pillars, or near the side windows. Accessories installed in these areas may interfere with proper operation of the vehicle's airbags or may be propelled into you or another occupant if the airbags deploy.
- Be sure electronic accessories do not overload electrical circuits or interfere with proper operation of your vehicle.
  - **Fuses** P. 790
- Before installing any electronic accessory, have the installer contact a dealer for assistance. If possible, have a dealer inspect the final installation.

### ➤ Accessories and Modifications

#### **⚠ WARNING**

**Improper accessories or modifications can affect your vehicle's handling, stability, and performance, and cause a crash in which you can be seriously hurt or killed.**

**Follow all instructions in this owner's manual regarding accessories and modifications.**

When properly installed, mobile phones, alarms, two-way radios, radio antennas, and low-powered audio systems should not interfere with your vehicle's computer controlled systems, such as your airbags and anti-lock brakes.

Honda Genuine accessories are recommended to ensure proper operation on your vehicle.

## Modifications

---

Do not modify your vehicle in a manner that may affect its handling, stability, or reliability, or install non-genuine Honda parts or accessories that may have a similar effect.

Even minor modifications to vehicle systems can affect overall vehicle performance. Always make sure all equipment is properly installed and maintained, and do not make any modification to your vehicle or its systems that might cause your vehicle to no longer meet your country's and local regulations.

The on-board diagnostic port (OBD-II/SAE J1962 connector) installed on this vehicle is intended to be used with automobile system diagnostic devices or with other devices that Honda has approved. Use of any other type of device may adversely affect the vehicle's electronic systems or allow them to be compromised, possibly resulting in a system malfunction, drained battery, or other unexpected problems.

Do not modify or attempt to repair any of the electrical components.



# Handling the Unexpected

This chapter explains how to handle unexpected troubles.



<b>Tools</b>	
Types of Tools.....	742
<b>If a Tyre Goes Flat</b>	
Models with a compact spare tyre	
Changing a Flat Tyre.....	744
Temporarily Repairing a Flat Tyre.....	755
<b>Handling of the Jack</b> .....	767
<b>Engine Does Not Start</b>	
Checking the Engine.....	768
If the Keyless Remote Battery is Weak..	770
Emergency Engine Stop .....	771
<b>If the Battery Is Dead</b> .....	772
<b>Shift Lever Does Not Move</b> .....	776

<b>Overheating</b> .....	779
<b>Indicator, Coming On/Blinking</b>	
If the Low Oil Pressure Indicator Comes On.....	782
If the Charging System Indicator Comes On .....	782
If the Malfunction Indicator Lamp Comes On or Blinks .....	783
If the Brake System Indicator (Red) Comes On or Blinks .....	784
If the Brake System Indicator (Red) comes on or blinks at the same time when the Brake System Indicator (Amber) comes on ...	785

If the Electric Power Steering (EPS) System Indicator Comes On.....	786
If the Low Tyre Pressure/Deflation Warning System Indicator Comes On or Blinks..	787
If the Low Oil Level Symbol Appears..	789
<b>Fuses</b>	
Fuse Locations .....	790
Inspecting and Changing Fuses.....	796
<b>Emergency Towing</b> .....	797
<b>If You Cannot Unlock the Fuel Fill Door</b> ..	800
<b>If You Cannot Open the Hatch</b> .....	801
<b>Refueling</b> .....	802

# Tools

## Types of Tools

Models with a compact spare tyre

Models without tool case

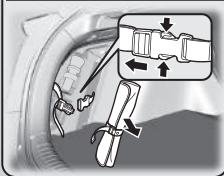

Models with tool case

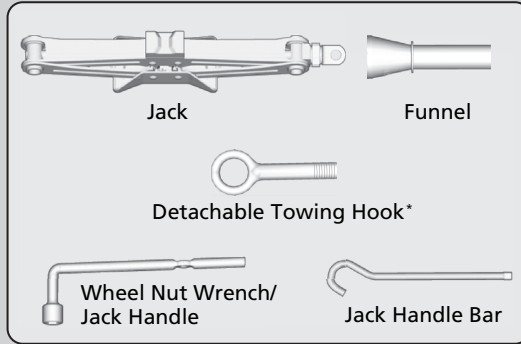
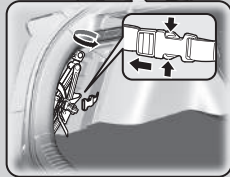
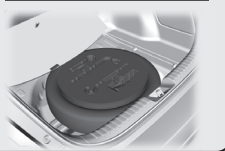

### Types of Tools

The tools were stored in the luggage area.

Models with temporary tyre repair kit

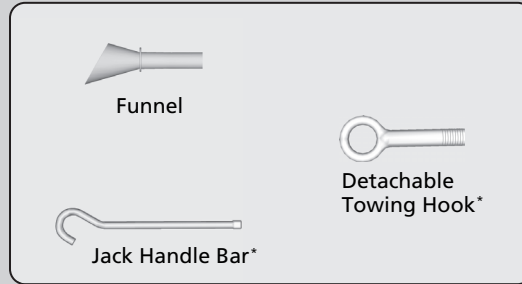
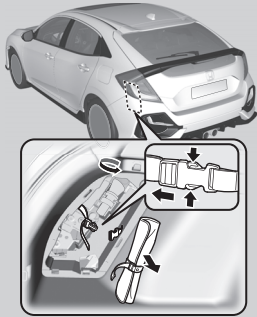

\* Not available on all models

# If a Tyre Goes Flat

Models with a compact spare tyre

## Changing a Flat Tyre

If a tyre goes flat while driving, grasp the steering wheel firmly, and brake gradually to reduce speed. Then, stop in a safe place. Replace the flat tyre with a compact spare tyre. Go to a dealer as soon as possible to have the full-size tyre repaired or replaced.

1. Park the vehicle on a firm, level, non-slippery surface and apply the parking brake.

Continuously variable transmission models

2. Put the transmission into **P**.

Manual transmission models

2. Put the transmission into **R**.

All models

3. Turn on the hazard warning lights and turn the ignition switch to LOCK **0**\*<sup>1</sup>.

\*1: Models with the keyless access system have an **ENGINE START/STOP** button instead of an ignition switch.

### Changing a Flat Tyre

Follow compact spare precautions:  
Periodically check the tyre pressure of the compact spare. It should be set to the specified pressure.  
Specified Pressure: 420 kPa (4.2 bar, 60 psi)

When driving with the compact spare tyre, keep the vehicle speed under 80 km/h (50 mph). Replace with a full-size tyre as soon as possible.

The compact spare tyre and wheel in your vehicle are specifically for this model. Do not use them with another vehicle. Do not use another type of compact spare tyre or wheel with your vehicle.

Do not mount tyre chains on a compact spare tyre. If a chain-mounted front tyre goes flat, remove one of the full-size rear tyres and replace it with the compact spare tyre. Remove the flat front tyre and replace it with the full-size tyre that was removed from the rear. Mount the tyre chains on the front tyre.

A compact spare tyre gives a harsher ride and less traction on some road surfaces. Use greater caution while driving.

Do not use more than one compact spare tyre at the same time.

The compact spare tyre is smaller than the regular tyre. Your vehicle's ground clearance reduces when the compact spare tyre is installed. Driving over road debris or bumps could possibly damage the underside of your vehicle.



## ■ Getting Ready to Replace the Flat Tyre

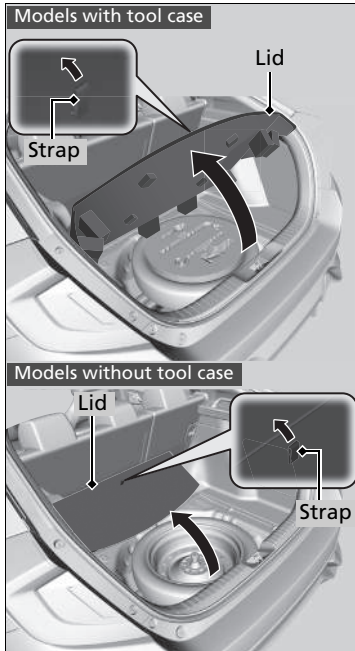

1. Pull the strap on the luggage area floor lid and open the lid.

### » Getting Ready to Replace the Flat Tyre

**WARNING:** The jack can only be used for helping an emergency vehicle breakdown, not for changing the regular seasonal tyre or any other normal maintenance or repair operation.

#### NOTICE

Do not use the jack if it doesn't work properly. Call your dealer or a professional towing service.

Continued

►► If a Tyre Goes Flat ► Changing a Flat Tyre

---

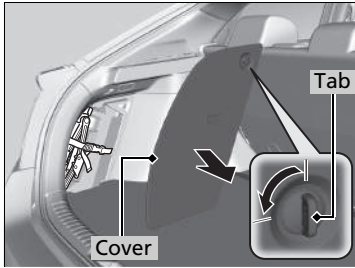

**2.** Turn and pull the tab to open the compartment cover located on the left side of the luggage area.

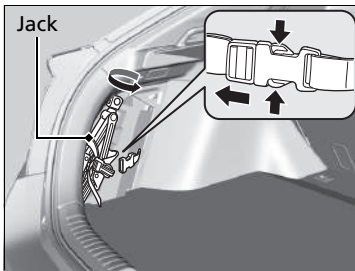

**3.** Turn the jack's end bracket to loosen it, then remove it.

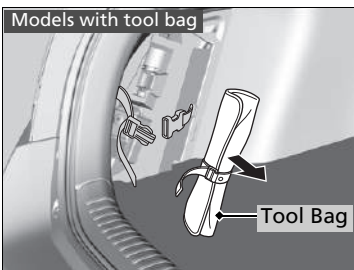
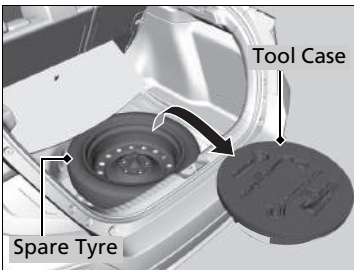
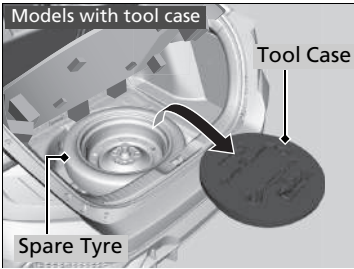

**Models with tool case**

4. Take the tool case out of the luggage area. Take the jack handle bar and wheel nut wrench out of the tool case.

**Models with tool bag**

4. Take the tool bag out of the compartment. Take the jack handle bar and wheel nut wrench out of the tool bag.

**All models**

5. Unscrew the wing bolt, and remove the spacer cone. Then, remove the spare tyre.

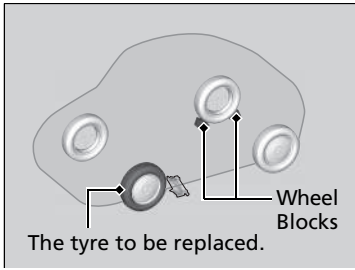

6. Place a wheel block or rock in front and rear of the wheel diagonal to the flat tyre.

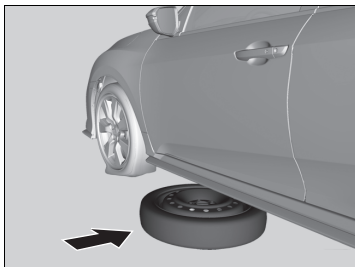

7. Place the compact spare tyre (wheel side up) under the vehicle body, near the tyre that needs to be replaced.

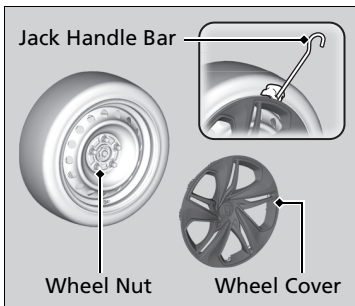

**Models with wheel cover**

8. Put the flat tip of the jack handle bar into the edge of the wheel cover. Carefully pry the edge and remove the cover.
- Wrap a cloth around the flat tip of the jack handle bar to prevent scratches on the cover.



All models

9. Loosen each wheel nut about one turn using the wheel nut wrench.

## How to Set Up the Jack

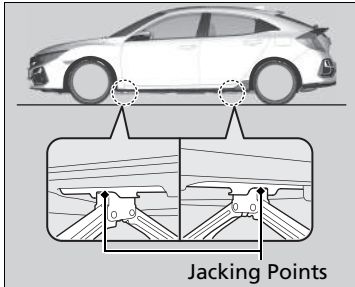

Jacking Points

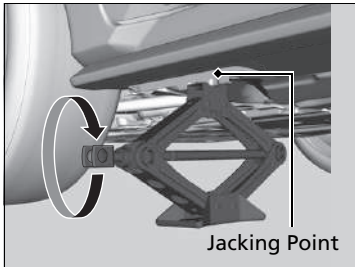

Jacking Point

1. Place the jack under the jacking point closest to the tyre to be changed.

2. Turn the end bracket clockwise as shown in the image until the top of the jack contacts the jacking point.

► Make sure that the jacking point tab is resting in the jack notch.

## How to Set Up the Jack

### **⚠ WARNING**

The vehicle can easily roll off the jack, seriously injuring anyone underneath.

Follow the directions for changing a tyre exactly, and no person should place any portion of their body under a vehicle that is supported by a jack.

#### Models with rear fog light

The jack that came with your vehicle has the following label.

1.	2.	3.

1. See Owner's Manual.
2. Never get under vehicle when supported by jack.
3. Place jack underneath reinforced area.

**WARNING:** The jack shall be placed on a flat and stable surface on the same level as the vehicle is parked.

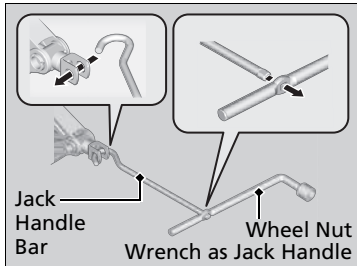

3. Raise the vehicle, using the jack handle bar and the jack handle, until the tyre is off the ground.

#### How to Set Up the Jack

Do not use the jack with people or luggage in the vehicle.

Use the jack provided in your vehicle. Other jacks may not support the weight ("load") or may not fit the jacking point.

The following instructions must be followed to use the jack safely:

- Do not use while the engine is running.
- Use only where the ground is firm and level.
- Use only at the jacking points.
- Do not get in the vehicle while using the jack.
- Do not put anything on top of or underneath the jack.

## Replacing the Flat Tyre

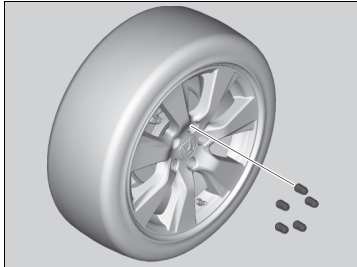

1. Remove the wheel nuts and flat tyre.

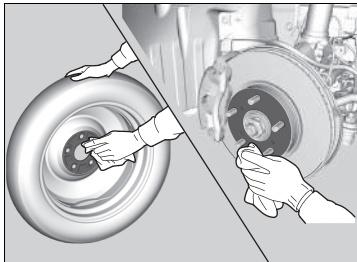

2. Wipe the mounting surfaces of the wheel with a clean cloth.

3. Mount the compact spare tyre.

4. Screw the wheel nuts until they touch the lips around the mounting holes, then stop rotating.

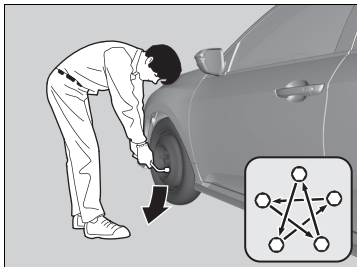

5. Lower the vehicle and remove the jack. Tighten the wheel nuts in the order indicated in the image. Go around, tightening the nuts, two to three times in this order.

### Wheel nut torque:

**1.0 L and 1.5 L engine models**

108 N·m (11 kgf·m, 80 lbf·ft)

**2.0 L engine models**

127 N·m (13 kgf·m, 94 lbf·ft)

## Replacing the Flat Tyre

Do not over tighten the wheel nuts by applying extra torque using your foot or a pipe.

### Models with wheel cover

Make sure the wire support ring is hooked into the clips around the edge of the wheel cover.

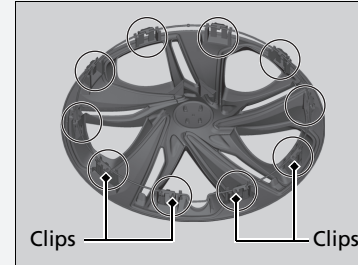

Align the valve mark on the wheel cover to the tyre valve on the wheel, then install the wheel cover.

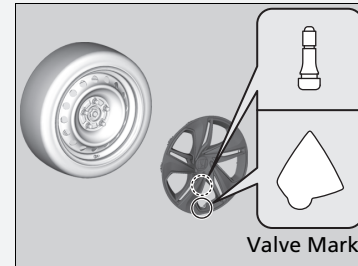



## ■ Storing the Flat Tyre

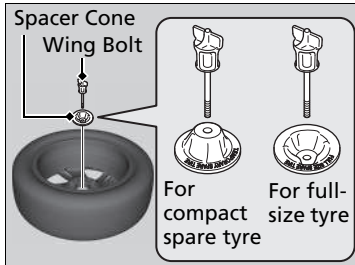
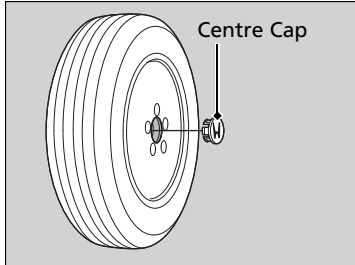

### Models with aluminium wheels

1. Remove the centre cap.
2. Place the flat tyre face down in the spare tyre well.
3. Remove the spacer cone from the wing bolt, flip it over, and insert it back on the bolt. Secure the flat tyre with the wing bolt.

### All models

### Models with tool case

4. Securely put the jack handle bar and wheel nut wrench back in the tool case. Store the case in the luggage area.

### Models with tool bag

4. Securely put the jack handle bar and wheel nut wrench back in the tool bag. Store the bag in the compartment on the left side.
5. Store the jack in the compartment on the left side. Turn the jack's end bracket to lock it in place.

## ▶▶ Replacing the Flat Tyre

### Models with wheel cover

Make sure the wire support ring is on the outer side of the tyre valve as shown.

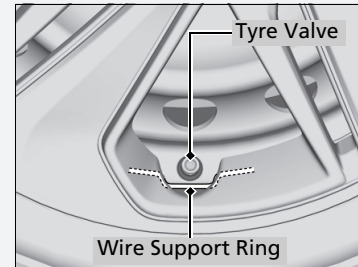

### ▶▶ Storing the Flat Tyre

## ⚠ WARNING

Loose items can fly around the interior in a crash and can seriously injure the occupants.

Store the wheel, jack, and tools securely before driving.

### ■ Deflation Warning System and the Compact Spare Tyre

If you replace a flat tyre with the spare tyre, the low tyre pressure/deflation warning system indicator comes on while you are driving. After driving for a few kilometres,  will appear on the driver information interface and the indicator will start blinking for a short time and then stay on; however, this is normal and is no cause for concern.

Calibrate the deflation warning system when you replace the tyre with a specified regular tyre.

🔧 **Deflation Warning System Initialisation** P. 550

## Temporarily Repairing a Flat Tyre

If the tyre has a large cut or is otherwise severely damaged, you will need to have the vehicle towed. If the tyre only has a small puncture, from a nail for instance, you can use the temporary tyre repair kit so that you can drive to the nearest service station for a more permanent repair.

If a tyre goes flat while driving, grasp the steering wheel firmly, and brake gradually to reduce speed. Then stop in a safe place.

1. Park the vehicle on firm, level, and non-slippery surface and apply the parking brake.

### Continuously variable transmission models

2. Put the transmission into **P**.

### Manual transmission models

2. Put the transmission into **R**.

### All models

3. Turn on the hazard warning lights and turn the ignition switch to LOCK **0**\*1.

\*1: Models with the keyless access system have an **ENGINE START/STOP** button instead of an ignition switch.

### Temporarily Repairing a Flat Tyre

The kit should not be used in the following situations. Instead, contact a dealer or a roadside assistant to have the vehicle towed.

- The tyre sealant has expired.
- More than one tyre is punctured.
- The puncture or cut is larger than 4 mm (3/16 inch).
- The tyre side wall is damaged or the puncture is outside the contact area.

	When the puncture is:	Kit Use
	Smaller than 4 mm (3/16 inch)	Yes
	Larger than 4 mm (3/16 inch)	No

- Damage has been caused by driving with the tyres extremely under inflated.
- The tyre bead is no longer seated.
- The rim is damaged.

Do not remove a nail or screw that punctured the tyre. If you remove it from the tyre, you may not be able to repair the puncture using the kit.

### ■ Getting Ready to Temporarily Repair the Flat Tyre

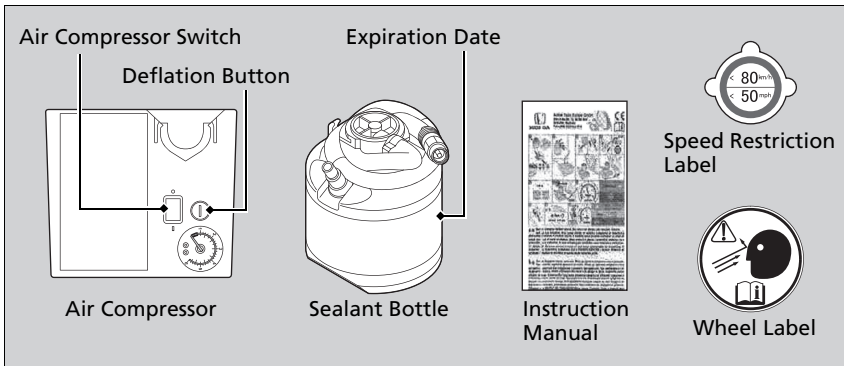

### ▣ Getting Ready to Temporarily Repair the Flat Tyre

When making a temporary repair, carefully read the instruction manual provided with the kit.

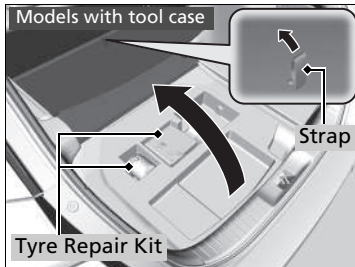

**Models with tool case**

1. Pull the strap on the luggage area floor lid and open the lid.
2. Take the kit out of the tool case.
3. Place the kit face up, on flat ground near the flat tyre, and away from traffic. Do not place the kit on its side.

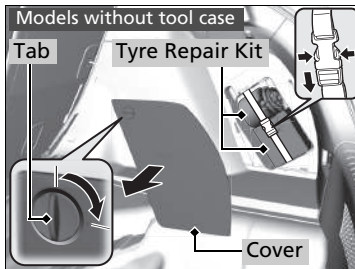

**Models without tool case**

1. Turn and pull the tab to open the compartment cover located on the right side of the luggage area.
2. Take the kit out of the rear right side compartment.
3. Place the kit, face up, on flat ground near the flat tyre, and away from traffic. Do not place the kit on its side.

## Injecting Sealant and Air

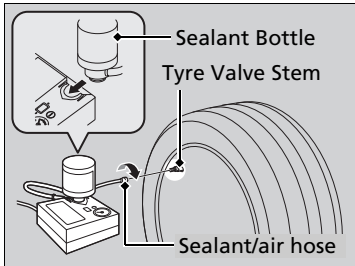
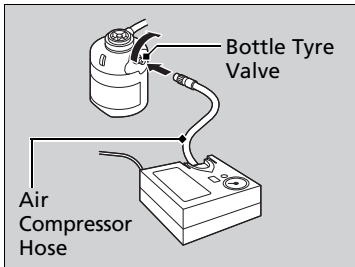
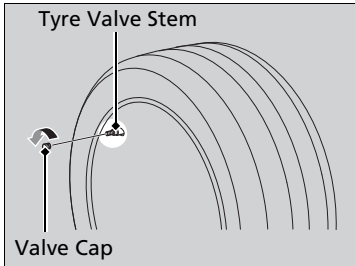

1. Remove the valve cap from the tyre valve stem.
2. Shake the sealant bottle.
3. Attach the air compressor hose onto the bottle tyre valve. Screw it until it is tight.
4. Upside down the sealant bottle, then attach the bottle into the cutout of the air compressor.
5. Attach the sealant/air hose onto the tyre valve stem. Screw it until it is tight.

## Injecting Sealant and Air

### **⚠ WARNING**

Tyre sealant contains substances that are harmful and can be fatal if swallowed.

If accidentally swallowed, do not induce vomiting. Drink plenty of water and get medical attention immediately.

For skin or eye contact, flush with cool water and get medical attention if necessary.

Keep the sealant bottle out of the reach of children.

In cold temperatures, the sealant may not flow easily. In this situation, warm it up for five minutes before using.

The sealant is latex based and can permanently stain clothing and other materials. Be careful during handling and wipe up any spills immediately.

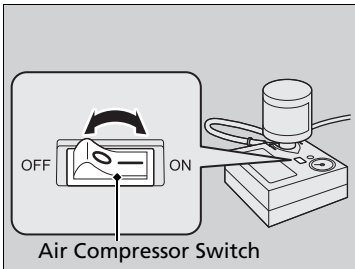
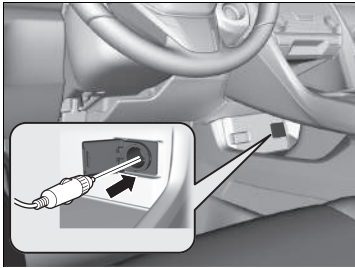

6. Plug in the compressor to the accessory power socket.
  - ▶ Be careful not to pinch the cord in a door or window.
  - ▶ Do not plug any other electric devices into other accessory power sockets.
    - ❏ **Accessory Power Socket** P. 259
7. Turn the ignition switch to START \*1 without depressing the accelerator pedal, then start the engine.
  - ❏ **Carbon Monoxide Gas** P. 104
8. Turn the air compressor on to inflate the tyre.
  - ▶ The compressor starts injecting sealant and air into the tyre.
9. After the air pressure reaches to specified pressure, turn off the kit.
  - ▶ Check the air pressure gauge on the air compressor.
  - ▶ Refer to the driver's doorjamb label for the specified pressure.

❏ Injecting Sealant and Air

**⚠ WARNING**

Running the engine with the vehicle in an enclosed or even partly enclosed area can cause a rapid build-up of toxic carbon monoxide.

Breathing this colourless, odourless gas can cause unconsciousness and even death. Only run the engine to power the air compressor with the vehicle outdoors.

**NOTICE**

Do not operate the temporary tyre repair kit compressor for more than 15 minutes. The compressor can overheat and become permanently damaged.

Until the sealant injection is complete, the pressure shown on the pressure gauge will appear higher than actual. After the sealant injection is complete the pressure will drop and then begin to rise again as the tyre is inflated with air. This is normal. To accurately measure the air pressure using the gauge, turn the air compressor off only after the sealant injection is complete.

If the required air pressure is not reached within 10 minutes, the tyre may be too severely damaged for the kit to provide the necessary seal and your vehicle will need to be towed.

See a Honda dealer for a replacement sealant bottle and proper disposal of an empty bottle.

\*1: Models with the keyless access system have an **ENGINE START/STOP** button instead of an ignition switch.

Continued

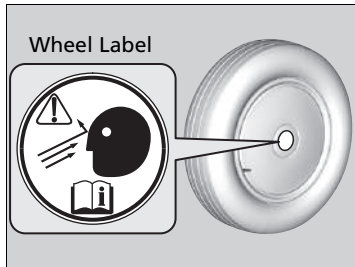

10. Unplug the kit from the accessory power socket.
11. Unscrew the sealant hose from the tyre valve stem. Reinstall the valve cap.
12. Apply the wheel label to the flat surface of the wheel.
  - The wheel surface must be clean to ensure the label adheres properly.



### ■ Distributing the Sealant in the Tyre

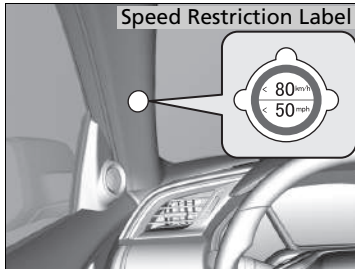

1. Apply the speed restriction label to the location as shown.
2. Drive the vehicle for about 10 minutes.
  - Do not exceed 80 km/h (50 mph).
3. Stop the vehicle in a safe place.

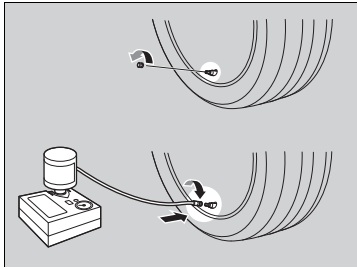

4. Recheck the air pressure using the gauge on the air compressor.
  - Do not turn the air compressor on to check the pressure.
5. If the air pressure is:
  - Less than 130 kPa (1.3 bar, 19 psi):  
Do not add air or continue driving. The leak is too severe. Call for help and have your vehicle towed.
    - ▣ **Emergency Towing** P. 797
  - Specified pressure more:  
Continue driving for another 10 minutes or until you reach the nearest service station. Do not exceed 80 km/h (50 mph).
- If the air pressure does not go down after the 10 minute driving, you do not need to check the pressure any more.

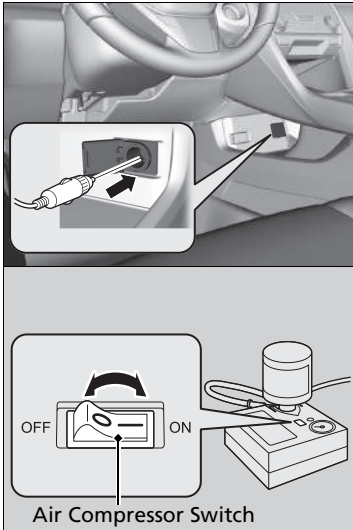

- Greater than 130 kPa (1.3 bar, 19 psi), but less than specified pressure: Turn the air compressor on to inflate the tyre until the tyre pressure reaches specified pressure.
  - **Inflating an Under-inflated Tyre** P. 764
 Then drive carefully for 10 more minutes or until you reach the nearest service station. Do not exceed 80 km/h (50 mph).
  - You should repeat this procedure as long as the air pressure is within this range.
- 6. Unplug the kit from the accessory power socket.
- 7. Unscrew the air only hose from the tyre valve stem. Reinstall the valve cap.
- 8. Press the pressure relief button until the gauge returns to 0 kPa (0 bar, 0 psi).
- 9. Repackage and properly stow the kit.

► Distributing the Sealant in the Tyre

**⚠ WARNING**

Running the engine with the vehicle in an enclosed or even partly enclosed area can cause a rapid build-up of toxic carbon monoxide.

Breathing this colourless, odourless gas can cause unconsciousness and even death. Only run the engine to power the air compressor with the vehicle outdoors.

Refer to the driver's doorjamb label for the specified pressure.

## ■ Inflating an Under-inflated Tyre

You can use the kit to inflate a non-punctured under-inflated tyre.

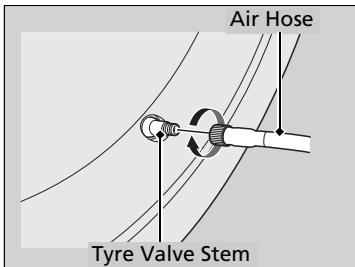
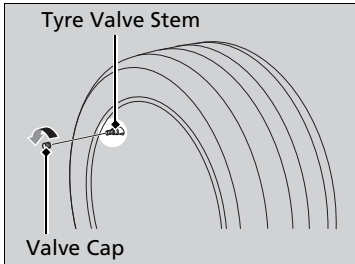
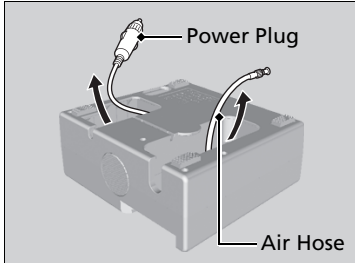

1. Take the kit out of the luggage area.  
    **➤ Getting Ready to Temporarily Repair the Flat Tyre P. 756**
2. Place the kit, face up, on flat ground near the flat tyre, away from traffic. Do not place the kit on its side.
3. Remove the air hose from the kit.
4. Remove the valve cap from the tyre valve stem.
5. Attach the air hose onto the tyre valve stem.  
    Screw it until it is tight.

## ▣ Inflating an Under-inflated Tyre

### ⚠ WARNING

Running the engine with the vehicle in an enclosed or even partly enclosed area can cause a rapid build-up of toxic carbon monoxide.

Breathing this colourless, odourless gas can cause unconsciousness and even death. Only run the engine to power the air compressor with the vehicle outdoors.

### NOTICE

Do not operate the temporary tyre repair kit compressor for more than 15 minutes. The compressor can overheat and become permanently damaged.

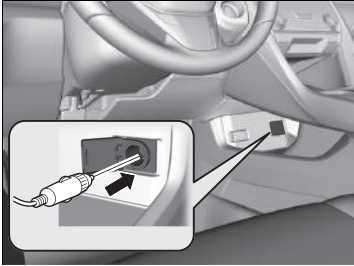

6. Plug in the compressor to the accessory power socket.
  - ▶ Be careful not to pinch the cord in a door or window.
  - ▶ **Accessory Power Socket** P. 259
7. Turn the ignition switch to ACCESSORY \*1.
  - ▶ In freezing temperatures, start the engine and leave it running while the flat tyre is being serviced.
  - ▶ **Carbon Monoxide Gas** P. 104

\*1: Models with the keyless access system have an **ENGINE START/STOP** button instead of an ignition switch.

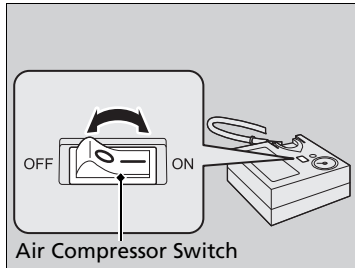

- 8.** Turn the air compressor switch on to inflate the tyre.
  - ▶ The compressor starts to inject air into the tyre.
  - ▶ If you have started the engine, leave it running while injecting air.
- 9.** Inflate the tyre to the specified air pressure.
- 10.** Turn off the kit.
  - ▶ Check the pressure gauge on the air compressor.
  - ▶ If overinflated, press the deflate button.
- 11.** Unplug the kit from the accessory power socket.
- 12.** Unscrew the air hose from the tyre valve stem. Reinstall the valve cap.
- 13.** Repackage and properly stow the kit.

## Handling of the Jack

Your vehicle has jacking points as shown.  
When replacing your tyres, consult a dealer.

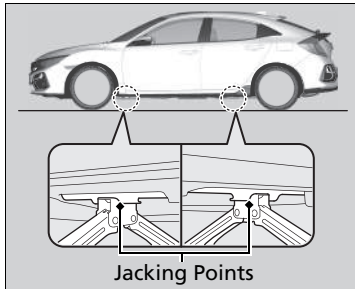

# Engine Does Not Start

## Checking the Engine

If the engine does not start, check the starter.

### ☒ Checking the Engine

If you must start the vehicle immediately, use an assisting vehicle or booster battery to jump start it.

☒ **If the Battery Is Dead** P. 772

Do not hold the **ENGINE START/STOP** button\* for more than 15 seconds.

### Starter condition

### Checklist

#### Starter doesn't turn or turns over slowly.

The battery may be dead. Check each of the items on the right and respond accordingly.

#### Models with keyless access system

#### Check for a message on the driver information interface.

- If the **To Start, Hold Remote Near Start Button** message or  appears.

☒ **If the Keyless Remote Battery is Weak** P. 770

- ▶ Make sure the keyless remote is in its operating range.

☒ **ENGINE START/STOP Button Operating Range** P. 219

#### Check the brightness of the interior lights.

Turn on the interior lights and check the brightness.

- If the interior lights are dim or do not come on at all

☒ **Battery** P. 722

- If the interior lights come on normally ☒ **Fuses** P. 790



Starter condition	Checklist
<p><b>The starter turns over normally but the engine doesn't start.</b> There may be a problem with the fuse. Check each of the items on the right and respond accordingly.</p>	<p><b>Review the engine start procedure.</b> Follow its instructions, and try to start the engine again. ➤ <b>Starting the Engine</b> P. 493, 496</p>
	<p><b>Check the immobilizer system indicator.</b> When the immobilizer system indicator is blinking, the engine cannot be started. ➤ <b>Immobilizer System</b> P. 207</p>
	<p><b>Check the fuel level.</b> There should be enough fuel in the tank. ➤ <b>Fuel Gauge</b> P. 159</p>
	<p><b>Check the fuse.</b> Check all fuses, or have your vehicle checked by a dealer. ➤ <b>Inspecting and Changing Fuses</b> P. 796</p>
	<p><b>If the problem continues:</b> ➤ <b>Emergency Towing</b> P. 797</p>

Model with keyless access system

## If the Keyless Remote Battery is Weak

If the beeper sounds, the **To Start, Hold Remote Near Start Button** message or  appears on the driver information interface, and the **ENGINE START/STOP** button flashes, and the engine won't start, start the engine as follows:

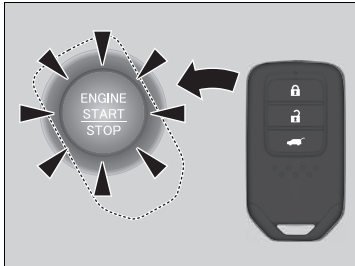

1. Touch the centre of the **ENGINE START/STOP** button with the **H** logo on the keyless remote while the **ENGINE START/STOP** button is flashing. The buttons on the keyless remote should be facing you.
  - ▶ The **ENGINE START/STOP** button flashes for about 30 seconds.

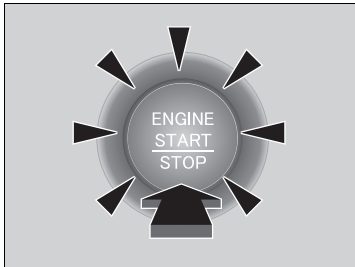

2. Depress the brake pedal (Continuously variable transmission) or clutch pedal (manual transmission) and press the **ENGINE START/STOP** button within 10 seconds after the beeper sounds and the **ENGINE START/STOP** button changes from flashing to on.
  - ▶ If you don't depress the pedal, the mode will change to ACCESSORY.

Model with keyless access system

## Emergency Engine Stop

The **ENGINE START/STOP** button may be used to stop the engine due to an emergency situation even while driving. If you must stop the engine, do either of the following operations:

- Press and hold the **ENGINE START/STOP** button for about two seconds.
- Firmly press the **ENGINE START/STOP** button three times.

The steering wheel will not lock.

Continuously variable transmission models

The power mode is in ACCESSORY when the engine is stopped. To change the mode to VEHICLE OFF, transmission is put into **P** after the vehicle comes to a complete stop. Then press the **ENGINE START/STOP** button twice without depressing the brake pedal.

Manual transmission models

The power mode changes to VEHICLE OFF.

### Emergency Engine Stop

Do not press the **ENGINE START/STOP** button while driving unless it is absolutely necessary for the engine to be turned off.

If you press the **ENGINE START/STOP** button while driving, the beeper sounds.

# If the Battery Is Dead

## Jump Starting Procedure

Turn off the power to electric devices, such as audio and lights. Turn off the engine, then open the bonnet.

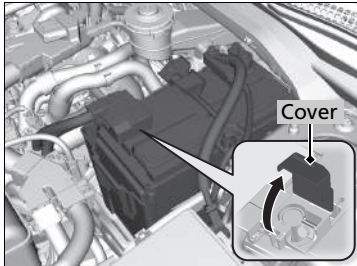

1. Open the terminal cover on the positive ⊕ terminal.
2. Connect the first jumper cable to your vehicle's battery ⊕ terminal.
3. Connect the other end of the first jumper cable to the booster battery ⊕ terminal.
  - ▶ Use a 12-volt booster battery only.
  - ▶ When using an automotive battery charger to boost your 12-volt battery, select a lower charging voltage than 15-volt. Check the charger manual for the proper setting.

## If the Battery Is Dead

### **⚠ WARNING**

A battery can explode if you do not follow the correct procedure, seriously injuring anyone nearby.

Keep all sparks, open flames, and smoking materials away from the battery.

### **NOTICE**

If a battery sits in extreme cold, the electrolyte inside can freeze. Attempting to jump start with a frozen battery can cause it to rupture.

Securely attach the jumper cables clips so that they do not come off when the engine vibrates. Also be careful not to tangle the jumper cables or allow the cable ends to touch each other while attaching or detaching the jumper cables.

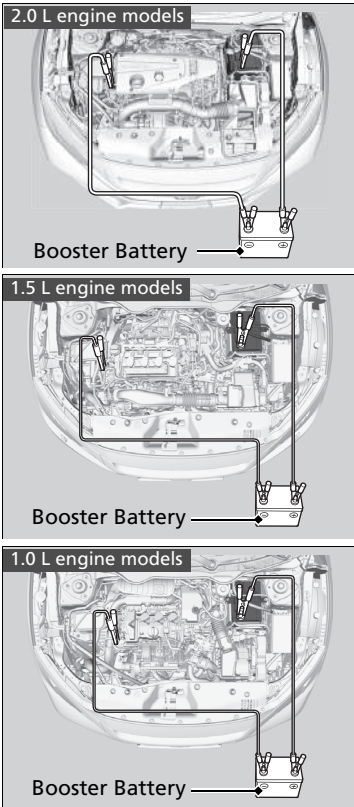

4. Connect the second jumper cable to the booster battery ⊖ terminal.

▶▶ If the Battery Is Dead

Battery performance degrades in cold conditions and may prevent the engine from starting.

▶▶ If the Battery Is Dead ▶▶

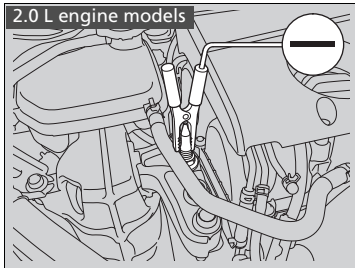

5. Connect the other end of the second jumper cable to the engine mounting bolt as shown. Do not connect this jumper cable to any other part.
6. If your vehicle is connected to another vehicle, start the assisting vehicle's engine and increase its rpm slightly.
7. Attempt to start your vehicle's engine. If it turns over slowly, check that the jumper cables have good metal-to-metal contact.

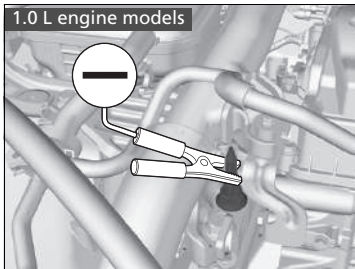
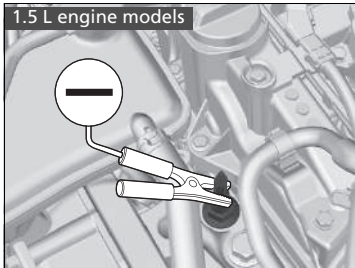

## ■ What to Do After the Engine Starts

Once your vehicle's engine has started, remove the jumper cables in the following order.

1. Disconnect the jumper cable from your vehicle's ground.
2. Disconnect the other end of the jumper cable from the booster battery ⊖ terminal.
3. Disconnect the jumper cable from your vehicle's battery ⊕ terminal.
4. Disconnect the other end of the jumper cable from the booster battery ⊕ terminal.

Have your vehicle inspected by a nearby service station or a dealer.

## ▣ If the Battery Is Dead

The indicators for the Adaptive Cruise Control (ACC)\*, Adaptive Cruise Control (ACC) with Low Speed Follow\*, Road Departure Mitigation\*, Vehicle Stability Assist (VSA) System, Vehicle Stability Assist (VSA) OFF, low tyre pressure/deflation warning system\*, deflation warning system\* and Collision Mitigation Braking System (CMBS)\* may come on when you turn the ignition switch to ON **II**\*<sup>1</sup> after reconnecting a battery.

Drive a short distance at more than 20 km/h (12 mph). Each indicator should go off. If it does not, have your vehicle checked by a dealer.

\*1: Models with the keyless access system have an **ENGINE START/STOP** button instead of an ignition switch.

\* Not available on all models

# Shift Lever Does Not Move

## Continuously variable transmission models

Follow the procedure below if you cannot move the shift lever out of the **P** position.

## Left-hand Drive Type

### Releasing the Lock

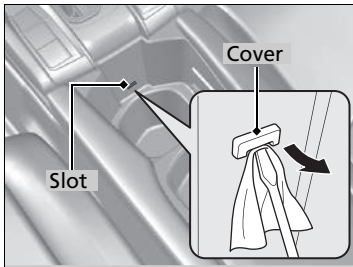

1. Set the parking brake.

#### Models without keyless access system

2. Remove the key from the ignition switch.

#### Models with keyless access system

2. Remove the built-in key from the keyless remote.

#### All models

3. Move the removable beverage holder tray rearward.

➤ **Front seat beverage holders** P. 257

4. Wrap a cloth around the tip of a small flat-tip screwdriver to remove the cover of the shift lock release slot. Put the tip of the flat-tip screwdriver into the slot and remove it as shown in the image.



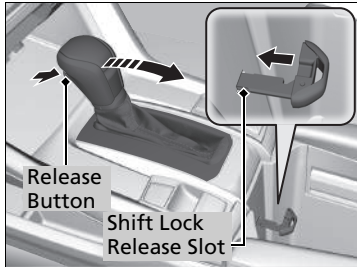

5. Insert the key into the shift lock release slot.
6. While pushing the key, press the shift lever release button, and place the shift lever into **N**.
  - ▶ The lock is now released. Have the shift lever checked by a dealer as soon as possible.

Right-hand Drive Type

■ Releasing the Lock

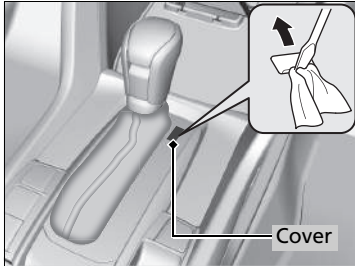

1. Set the parking brake.

Models without keyless access system

2. Remove the key from the ignition switch.

Models with keyless access system

2. Remove the built-in key from the keyless remote.

All models

3. Wrap a cloth around the tip of a small flat-tip screwdriver to remove the cover of the shift lock release slot. Put the tip of the flat-tip screwdriver into the slot and remove it as shown in the image.

4. Insert the key into the shift lock release slot.  
5. While pushing the key down, press the shift lever release button, and place the shift lever into **N**.

▶ The lock is now released. Have the shift lever checked by a dealer as soon as possible.

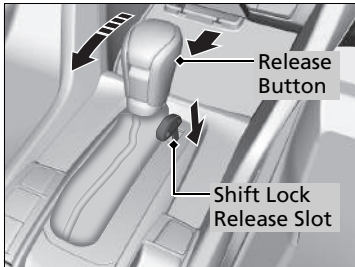

# Overheating

## How to Handle Overheating

Overheating symptoms are as follows:

- The temperature gauge pointer is at the upper level or the engine suddenly loses power.
- Steam or spray comes out of the engine compartment.

### ■ First thing to do

1. Immediately park the vehicle in a safe place.
2. Turn off all accessories and turn on the hazard warning lights.
  - ▶ **No steam or spray present:** Keep the engine running and open the bonnet.
  - ▶ **Steam or spray is present:** Turn off the engine and wait until it subsides. Then open the bonnet.

### » How to Handle Overheating

#### **WARNING**

Steam and spray from an overheated engine can seriously scald you.

Do not open the bonnet if steam is coming out.

#### **NOTICE**

Continuing to drive with the temperature gauge pointer at the upper level may damage the engine.

*Continued*

### ■ Next thing to do

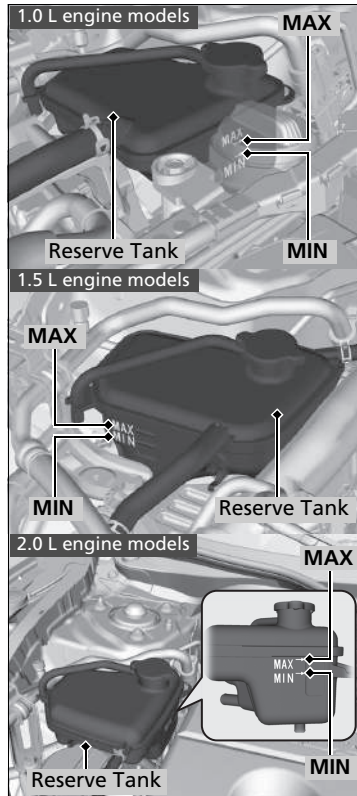

1. Check that the cooling fan is operating and stop the engine once the high temperature gauge pointer comes down.
  - If the cooling fan is not operating, immediately stop the engine.
2. Once the engine has cooled down, inspect the coolant level and check the cooling system components for leaks.
  - If the coolant level in the reserve tank is low, add coolant until it reaches the **MAX** mark.
  - If there is no coolant in the reserve tank, check that the radiator is cool. Cover the reserve tank cap with a heavy cloth and open the cap. If necessary, add coolant up to the base of the filler neck, and put the cap back on.

### How to Handle Overheating

## ⚠ WARNING

Removing the reserve tank cap while the engine is hot can cause the coolant to spray out, seriously scalding you.

Always let the engine and radiator cool down before removing the reserve tank cap.

If the coolant is leaking, contact a dealer for repairs.

Use water as an emergency/temporary measure only. Have a dealer flush the system with proper antifreeze as soon as possible.

■ **Last thing to do**

Once the engine has cooled sufficiently, restart it and check the temperature gauge. If the temperature gauge pointer has gone down, resume driving. If it has not gone down, contact a dealer for repairs.

## Indicator, Coming On/Blinking

### If the Low Oil Pressure Indicator Comes On



■ **Reasons for the indicator to come on**

Comes on when the engine oil pressure is low.

■ **What to do as soon as the indicator comes on**

1. Immediately park the vehicle on level ground in a safe place.
2. If necessary, turn the hazard warning lights on.

■ **What to do after parking the vehicle**

1. Stop the engine and let it sit for approximately three minutes.
2. Open the bonnet and check the oil level.
  - 🔧 **Oil Check** P. 690
3. Start the engine and check the low oil pressure indicator.
  - ▶ The indicator goes off: Start driving again.
  - ▶ The indicator does not go off within 10 seconds: Immediately stop the engine and contact a dealer for repairs.

### If the Charging System Indicator Comes On



■ **Reasons for the indicator to come on**

Comes on when the battery is not being charged.

■ **What to do when the indicator comes on**

Turn off the climate control system, rear demister, and other electrical systems, and immediately contact a dealer for repairs.

#### ⚠ If the Low Oil Pressure Indicator Comes On

**NOTICE**

Running the engine with low oil pressure can cause serious mechanical damage almost immediately.

#### ⚠ If the Charging System Indicator Comes On

If you need to stop temporarily, do not turn off the engine. Restarting the engine may rapidly discharge the battery.

## If the Malfunction Indicator Lamp Comes On or Blinks



### ■ Reasons for the indicator lamp to come on or blink

- Comes on when there is a problem with the engine emissions control system.
- Blinks when engine misfiring is detected.

### ■ What to do when the indicator lamp comes on

Avoid high speeds and immediately get your vehicle inspected at a dealer.

### ■ What to do when the indicator lamp blinks

Park the vehicle in a safe place with no flammable items and wait at least 10 minutes or more with the engine stopped until it cools.

### ▶▶ If the Malfunction Indicator Lamp Comes On or Blinks

#### NOTICE

If you drive with the malfunction indicator lamp on, the emissions control system and the engine could be damaged.

If the malfunction indicator lamp blinks again when restarting the engine, drive to the nearest dealer at 50 km/h (30 mph) or less. Have your vehicle inspected.

## If the Brake System Indicator (Red) Comes On or Blinks



(Red)

### ■ Reasons for the indicator to come on

- The brake fluid is low.
- There is a malfunction in the brake system.

### ■ What to do when the indicator comes on while driving

Depress the brake pedal lightly to check pedal pressure.

- If normal, check the brake fluid level the next time you stop.
- If abnormal, take immediate action. If necessary, downshift the transmission to slow the vehicle using engine braking.

### ■ Reasons for the indicator to blink

- There is a problem with the electric parking brake system.

### ■ What to do when the indicator blinks

- Avoid using the parking brake and have your vehicle checked by a dealer immediately.

### ☒ If the Brake System Indicator (Red) Comes On or Blinks

Have your vehicle repaired immediately.

It is dangerous to drive with low brake fluid. If there is no resistance from the brake pedal, stop immediately in a safe place. If necessary downshift the gears.

If the brake system indicator and **ABS** indicator come on simultaneously, the electronic brake distribution system is not working. This can result in vehicle instability under sudden braking.

Have your vehicle inspected by a dealer immediately.

If the Brake System Indicator (Red) blinks at the same time when the Brake System Indicator (Amber) comes on, the parking brake may not work.

Avoid using the parking brake and have your vehicle checked by a dealer immediately.

☒ **If the Brake System Indicator (Red) comes on or blinks at the same time when the Brake System Indicator (Amber) comes on**  
P. 785

If you repeatedly operate the electric parking brake in a short period of time, the brake stops operating to prevent heating of the system and the indicator blinks.

It returns to its original state in approximately 1 minute.



▶▶ Indicator, Coming On/Blinking ▶ If the Brake System Indicator (Red) comes on or blinks at the same time when the Brake System Indicator (Amber) comes on

## If the Brake System Indicator (Red) comes on or blinks at the same time when the Brake System Indicator (Amber) comes on



(Red)



(Amber)

■ **If the Brake System Indicator (red) comes on or blinks at the same time when the Brake System Indicator (amber) comes on, release the parking brake manually or automatically.**

🔧 **Parking Brake** P. 633

- If the Brake System Indicator (red) continuously comes on or blinks at the same time when the Brake System Indicator (amber) comes on, stop the vehicle in a safe place and have it inspected by a dealer immediately.
  - ▶ Preventing the vehicle from moving.

### Continuously variable transmission models

Put the transmission into **P**.

### Manual transmission models

Put the transmission into **1** or **R**.

- If only the Brake System Indicator (Red) is turned off, avoid using the parking brake and have your vehicle checked by a dealer immediately.

▶▶ If the Brake System Indicator (Red) comes on or blinks at the same time when the Brake System Indicator (Amber) comes on

If you apply the parking brake, you may not be able to release it.

If the Brake System Indicator (red) and the Brake System Indicator (amber) come on at the same time, the parking brake is working.

If the Brake System Indicator (red) blinks at the same time when the Brake System Indicator (amber) comes on, the parking brake may not work because it is checking the system.

## If the Electric Power Steering (EPS) System Indicator Comes On

---



### ■ Reasons for the indicator to come on

- Comes on when there is a problem with the EPS system.
- If you depress the accelerator pedal repeatedly to increase the engine speed while the engine is idling, the indicator comes on, and sometimes the steering wheel becomes harder to operate.

### ■ What to do when the indicator comes on

- Stop the vehicle in a safe place and restart the engine.  
If the indicator comes on and stays on, immediately have your vehicle inspected by a dealer.

Models with rear fog light

## If the Low Tyre Pressure/Deflation Warning System Indicator Comes On or Blinks



### ■ Reasons for the indicator to come on or blink

A tyre pressure is significantly low, or the deflation warning system has not been calibrated. If there is a problem with the deflation warning system, the indicator blinks for about one minute, and then stays on. If the compact spare tyre\* is installed, the indicator will either come on or it will first blink for about one minute, then stays on.

### ■ What to do when the indicator comes on

Drive carefully and avoid abrupt cornering and hard braking. Stop your vehicle in a safe place. Check the tyre pressure and adjust the pressure to the specified level. The specified tyre pressure is on a label on the driver side doorjamb.

- ▶ Calibrate the deflation warning system after the tyre pressure is adjusted.

### ➤ Deflation Warning System Initialisation P. 550

If the compact spare tyre\* causes the indicator to come on, change the tyre to a full-size tyre. The indicator goes off after calibrating the deflation warning system.

### ■ What to do when the indicator blinks, then remains on

Have the tyre inspected by a dealer as soon as possible. If the compact spare tyre\* causes the indicator first blink, and then stays on, change the tyre to a full-size tyre.

The indicator goes off after calibrating the deflation warning system.

▶▶ If the Low Tyre Pressure/Deflation Warning System Indicator Comes On or Blinks

### NOTICE

Driving on an extremely underinflated tyre can cause it to overheat. An overheated tyre can fail. Always inflate your tyres to the prescribed level.

\* Not available on all models

Models without rear fog light

## If the Deflation Warning System Indicator Comes On or Blinks



### ■ Reasons for the indicator to come on/blink

A tyre pressure is significantly low, or the deflation warning system has not been calibrated. If there is a problem with the deflation warning system, the indicator blinks for about one minute, and then stays on.

### ■ What to do when the indicator comes on

Drive carefully and avoid abrupt cornering and hard braking.

Stop your vehicle in a safe place. Check the tyre pressure and adjust the pressure to the specified level. The specified tyre pressure is on a label on the driver side doorjamb.

- Calibrate the deflation warning system after the tyre pressure is adjusted.

➤ **If a Tyre Goes Flat** P. 744

### ■ What to do when the indicator blinks

Have the tyre inspected by a dealer as soon as possible.

➤ If the Deflation Warning System Indicator Comes On or Blinks

### NOTICE

Driving on an extremely underinflated tyre can cause it to overheat. An overheated tyre can fail. Always inflate your tyres to the prescribed level.

Models with rear fog light

## If the Low Oil Level Symbol Appears



### ■ Reasons for the symbol to appear

Appears when the engine oil level is low.

### ■ What to do as soon as the symbol appears

1. Immediately park the vehicle on level ground in a safe place.
2. If necessary, turn the hazard warning lights on.

### ■ What to do after parking the vehicle

1. Stop the engine and let it sit for about three minutes.
2. Open the bonnet and check the oil level.
  - ▶ Add oil as necessary.
  - **Oil Check** P. 690

### ▶▶ If the Low Oil Level Symbol Appears

#### NOTICE

Running the engine with low oil level can cause serious mechanical damage almost immediately.

This system activates after the engine warms up. If the outside temperature is extremely low, you may have to drive for a long time until the system senses the engine oil level.

If the symbol appears again, stop the engine and contact a dealer for repairs immediately.



■ Circuit protected and fuse rating

	Circuit Protected	Amps
1	OP Block1 *	(60 A)
	VST1 (Idle Stop)*	30 A
	Cooling Fan* <sup>1, *2</sup>	50 A
	Main Fan* <sup>7</sup>	(30 A)
	Audio Amp*	(30 A)
	IG Main2*	(30 A)
	Headlight High Beam Main	30 A
	Battery (Main Fuse)	125 A* <sup>1, *7</sup> 150 A* <sup>2</sup>
	EPS	70 A
	IG Main1	30 A* <sup>3</sup> 50 A* <sup>4</sup>
2	Fuse Box Option*	(40 A)
	Fuse Box Main	60 A
	Front Wiper Motor	30 A
	Headlight Low Beam Main	30 A
3	Rear Demister	40 A
	Starter Motor	30 A
	Fuse Box	40 A
	ABS/VSA Motor	40 A
	ABS/VSA FSR	40 A
	Blower Motor	40 A

	Circuit Protected	Amps
4	–	(40 A)
	PTC HTR2*	(40 A)
	–	(40 A)
	PTC HTR4*	(40 A)
5	Cooling Fan* <sup>1, *2</sup>	5 A
6	Washer	15 A
7	IGP	15 A* <sup>1</sup> 20 A* <sup>2, *7</sup>
8	Stop Lights	10 A
9	FI Sub	15 A
10	Injector* <sup>1</sup>	(15 A)
	EVP* <sup>2</sup>	(30 A)
	Sub Fan* <sup>7</sup>	(20 A)
11	LAF	5 A
12	FI ECU	10 A
13	Hazard	15 A
14	Rear Seat Heater*	(15 A)
15	IG Coil	15 A
16	Transmission*	(15 A)
17	Daytime Running Lights	10 A
18	Back Up	10 A
19	Audio	15 A
20	Position Lights	10 A

	Circuit Protected	Amps
21	Interior Lights	10 A
22	Fog Lights*	(15 A)
23	A/C Compressor*	10 A
24	Horn	10 A
25	Audio*	(30 A)
26	Left Headlight Low Beam	10 A
27	Right Headlight Low Beam	10 A
28	Back Up2	(30 A)* <sup>5</sup>
	Stop Switch	(5 A)* <sup>6</sup>
29	Left Headlight High Beam	10 A
30	Right Headlight High Beam	10 A
31	ADS*	(15 A)
32	Headlight Washer*	(30 A)
33	VB ACT* <sup>1</sup>	(5 A)

\*1: 1.5 L engine models

\*2: 1.0 L engine models

\*3: Models with keyless access system

\*4: Models without keyless access system

\*5: Models with Idle Stop

\*6: Models without Idle Stop system and models with trailer hitch harness

\*7: 2.0 L engine models

\* Not available on all models

## Interior Fuse Box

### ■ Fuse Box A

Located under the dashboard.

Fuse locations are shown on the image below.

Locate the fuse in question by the fuse number in the image and chart.

Left-hand Drive Type

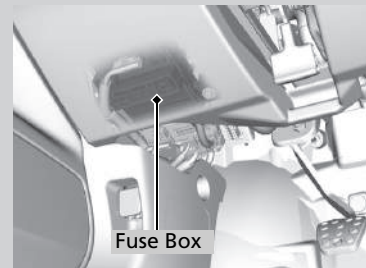

Right-hand Drive Type

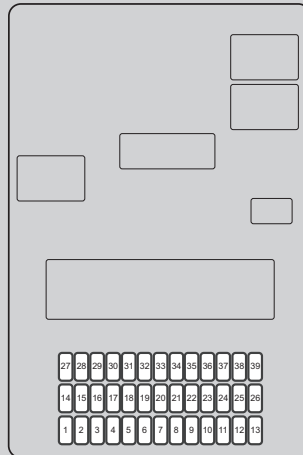
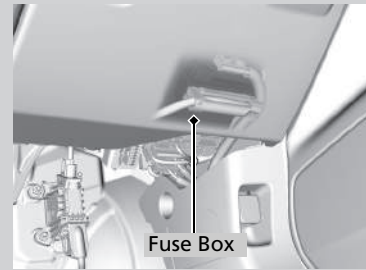



■ **Circuit protected and fuse rating**

	Circuit Protected	Amps
1	Accessory	10 A
2	Key Lock	5 A
3	Rear Wiper Motor*	(10 A)
4	Option3* <sup>6, *7</sup> Transmission* <sup>8</sup>	(5 A) (10 A)
5	Option	10 A
6	Option2* <sup>3, *4</sup>	10 A
7	Meter	10 A
8	Fuel Pump	(15 A)* <sup>3, *4</sup> (20 A)* <sup>5</sup>
9	AIRCON	10 A
10	Rear Accessory Power Socket*	(20 A)
11	Monitor* <sup>3</sup>	(5 A)
12	Right Side Door Lock	10 A
13	Left Side Door Unlock	10 A
14	Rear Left Side Power Window	20 A
15	Front Passenger's Side Power Window	20 A

	Circuit Protected	Amps
16	Door Lock	20 A
17	Transmission* <sup>9</sup> Option3* <sup>2</sup>	(10 A) (5 A)
18	Power Lumbar*	(10 A)
19	Sunroof*	(20 A)
20	Starter*	(10 A)
21	ACG	10 A* <sup>3, *5</sup> 15 A* <sup>4</sup>
22	Daytime Running Lights	10 A
23	Rear Fog Light*	10 A
24	Option*	(5 A)
25	Driver's Door Lock	10 A
26	Right Side Door Unlock	10 A
27	Rear Right Side Power Window	20 A
28	Driver's Power Window	20 A
29	Front Accessory Power Socket	20 A
30	Smart* <sup>1</sup> STS* <sup>2</sup>	(10 A) (5 A)

	Circuit Protected	Amps
31	–	–
32	Front Seat Heater*	(20 A)
33	–	–
34	VSA/ABS	10 A
35	SRS	10 A
36	HAC Option	20 A
37	–	–
38	Left Side Door Lock	10 A
39	Driver's Door Unlock	10 A

- \*1: Models with keyless access system
- \*2: Models without keyless access system
- \*3: 1.5 L engine models
- \*4: 1.0 L engine models
- \*5: 2.0 L engine models
- \*6: Models with keyless access system and 1.0 L engine models
- \*7: Models with keyless access system and 1.5 L engine models
- \*8: Continuously variable transmission models without keyless access system
- \*9: Continuously variable transmission models with keyless access system

\* Not available on all models

■ **Fuse Box B\***

Located under the dashboard.

Fuse locations are shown on the image below.

Locate the fuse in question by the fuse number in the image and chart.

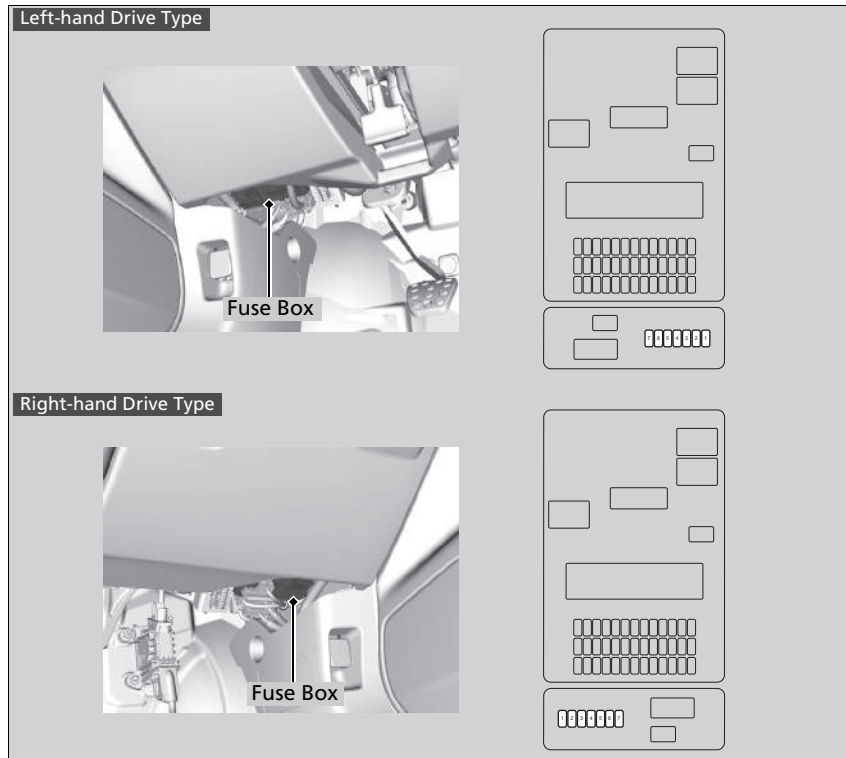

■ **Circuit protected and fuse rating**

	Circuit Protected	Amps
1	Accessory*	(10 A)
2	EOP*	(10 A)
3	Back Up2	10 A
4	Audio	15 A
5	Accessory Cut	10 A
6	VST 1	10 A
7	Stop Sw 2*	(5 A)

\* Not available on all models

## Inspecting and Changing Fuses

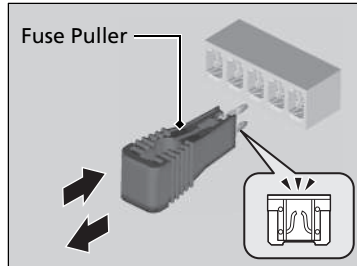
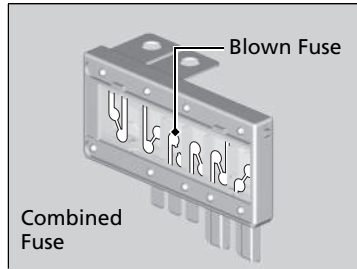

1. Turn the ignition switch to LOCK [0]\*1. Turn headlights and all accessories off.
2. Remove the fuse box cover.
3. Check the large fuse in the engine compartment.
  - If the fuse is blown, use a Phillips-head screwdriver to remove the screw and replace it with a new one.
4. Inspect the small fuses in the engine compartment and the vehicle interior.
  - If there is a blown fuse, remove it with the fuse puller and replace it with a new one.

### ► Inspecting and Changing Fuses

#### NOTICE

Replacing a fuse with one that has a higher rating greatly increases the chances of damaging the electrical system.

Use the charts to locate the fuse in question and confirm the specified amperage.

#### ► Fuse Locations P. 790

Replace fuse with a spare fuse of the same specified amperage.

#### Models without rear fog light

There is a fuse puller on the back of the engine compartment fuse box cover.

\* 1: Models with the keyless access system have an **ENGINE START/STOP** button instead of an ignition switch.

# Emergency Towing

Call a professional towing service if you need to tow your vehicle.

## ■ Flat bed equipment

The operator loads your vehicle on the back of a truck.

**This is the best way to transport your vehicle.**

## ■ Wheel lift equipment

The tow truck uses two pivoting arms that go under the front tyres and lift them off the ground. The rear tyres remain on the ground. **This is an acceptable way to tow your vehicle.**

## » Emergency Towing

### NOTICE

Trying to lift or tow your vehicle by the bumpers will cause serious damage. The bumpers are not designed to support the vehicle's weight.

Make sure the parking brake is released. If you cannot release the parking brake, your vehicle must be transported by the flat bed equipment.

➤ **Parking Brake** P. 633

### NOTICE

Improper towing such as towing behind a motorhome or other motor vehicle can damage the transmission.

Never tow your vehicle with just a rope or chain. It is very dangerous since ropes or chains may shift from side to side or break.

*Continued*

■ If your vehicle must be towed with the front wheels on the ground:

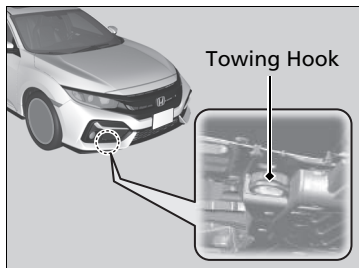

**Continuously variable transmission models**

1. Check for any fluid leaks on the ground, underneath the transmission housing.

- ▶ If you find a leak, call a professional towing service and have your vehicle inspected by a dealer.

**All models**

2. Hook the towing device to the towing hook.

3. Start the engine.

- ▶ If it is difficult to turn on the engine, put the ignition switch in ACCESSORY

**I**\*1 or ON **II**\*1.

\*1: Models with the keyless access system have an **ENGINE START/STOP** button instead of an ignition switch

☒ If your vehicle must be towed with the front wheels on the ground:

Towing a vehicle is prohibited by law in some countries. Check and follow the legal requirements of the country you are driving before towing your vehicle.

If you cannot follow the exact procedure, do not tow your vehicle with the front wheels on the ground.

If you cannot turn on the engine, you may experience the following while your vehicle is being towed.

**Models with keyless access system**

- Check that the steering wheel is not locked.

**All models**

- Braking may become difficult since the brake system's power assist is disabled.
- Steering wheel becomes heavy as the power steering system is disabled.

**Manual transmission models**

- Turning the ignition switch to LOCK **0**\*1 locks the steering wheel.

Going down a long slope heats up the brakes. This may prevent the brakes from working properly. If your vehicle needs to be towed on an incline, call a professional towing service.

With the front wheels on the ground, it is best to tow the vehicle no farther than 80 km, and keep the speed below 55 km/h.

**Continuously variable transmission models**

4. Depress the brake pedal.
5. Shift to **D** and hold for five seconds, then to **N**.
6. Release the parking brake.

**Manual transmission models**

4. Shift to **N**.
5. Release the parking brake.

▶▶ If your vehicle must be towed with the front wheels on the ground:

**Manual transmission models**

Do not slip the clutch for a long time to get unstuck. This may overheat and damage the transmission.

**NOTICE**

**Continuously variable transmission models**

If you cannot shift the transmission or turn on the engine, will damage the transmission. Your vehicle must be transported with the front wheels off the ground.

# If You Cannot Unlock the Fuel Fill Door

## What to Do If Unable to Unlock the Fuel Fill Door

If you cannot unlock the fuel fill door, use the following procedure.

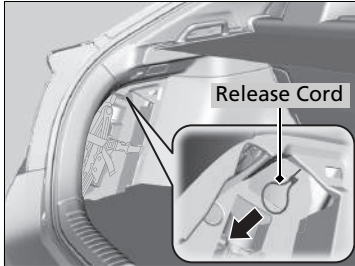

1. Open the hatch.
2. Pull the strap on the luggage area floor lid and open the lid.
3. Turn and pull the tab to open the compartment cover located on the left side of the luggage area.
4. Pull the release cord toward you.
  - ▶ The release cord unlocks the fuel fill door when it is pulled.

## ☒ If You Cannot Unlock the Fuel Fill Door

After taking these steps, contact a dealer to have the vehicle checked.



## If You Cannot Open the Hatch

### What to Do If Unable to Open the Hatch

If you cannot open the hatch, use the following procedure.

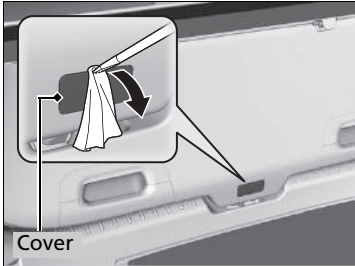

1. Use a flat-tip screwdriver and remove the cover on the back of the hatch.
  - ▶ Wrap the flat-tip screwdriver with a cloth to prevent scratches.

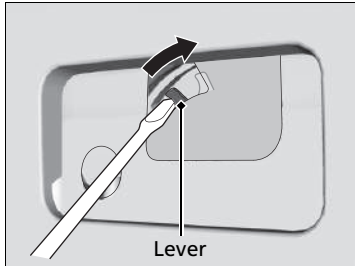

2. To open the hatch, push the hatch while sliding the lever with the flat-tip screw driver.

### If You Cannot Open the Hatch

Following up:  
After taking these steps, contact a dealer to have the vehicle checked.

When you open the hatch from inside, make sure there is enough space around the hatch, and it does not hit anyone or any object.

# Refueling

## Refueling From a Portable Fuel Container

If you have run out of fuel and need to refuel your vehicle from a portable fuel container, use the funnel provided with your vehicle.

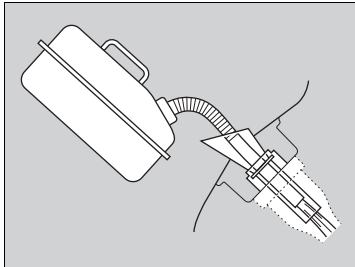
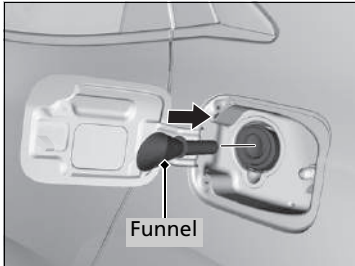

1. Turn off the engine.
2. Press on the edge of the fuel fill door to make it pop up slightly.
  - ▶ The fuel fill door opens.
3. Take the funnel out of the luggage area.
  - ▶ **Types of Tools** P. 742
4. Place the end of the funnel on the lower part of filler opening, then insert it slowly and fully.
  - ▶ Make sure that the end of the funnel goes down along with the filler pipe.
5. Fill the tank with fuel from the portable fuel container.
  - ▶ Pour fuel carefully so you do not spill any.
6. Remove the funnel from the filler neck.
  - ▶ Wipe up any fuel from the funnel before storing it.
7. Shut the fuel fill door by hand.

### Refueling From a Portable Fuel Container

#### **WARNING**

Fuel is highly flammable and explosive. You can be burned or seriously injured when handling fuel.

- Stop the engine, and keep heat, sparks, and flame away.
- Handle fuel only outdoors.
- Wipe up spills immediately.

#### **NOTICE**

Do not insert the nozzle of a portable fuel container or any funnel other than the one provided with your vehicle. Doing so can damage the fuel system. Do not try to pry open or push open the sealed fuel tank with foreign objects. This can damage the fuel system and its seal.

Make sure the fuel in the portable fuel container is petrol before you refuel.

# Information

This chapter includes your vehicle's specifications, locations of identification numbers, and other information required by regulation.

<b>Specifications</b> .....	804
<b>Identification Numbers</b>	
Vehicle Identification Number (VIN), Engine Number and Transmission Number .....	808
<b>Devices that Emit Radio Waves*</b> .....	811
<b>EC Declaration of Conformity Content Outline*</b> .....	824

\* Not available on all models

# Specifications

## Vehicle Specifications

Model	Civic <sup>1</sup> Civic TYPE R <sup>2</sup>
Curb Weight	<b>1.0 L engine models</b>
	1,239 – 1,371 kg (2,731 – 3,023 lbs) <sup>3</sup>
	1,229 – 1,362 kg (2,709 – 3,003 lbs) <sup>4</sup>
	<b>1.5 L engine models</b>
1,341 – 1,396 kg (2,956 – 3,078 lbs) <sup>3</sup>	1,308 – 1,362 kg (2,884 – 3,003 lbs) <sup>4</sup>
	<b>2.0 L engine models</b>
1,362 – 1,420 kg (3,003 – 3,131 lbs) <sup>7</sup>	1,387 – 1,390 kg (3,058 – 3,064 lbs) <sup>8</sup>
	Maximum Permissible Weight
Maximum Permissible Axle Weight	See the certification label on the passenger's doorjamb <sup>5</sup> See the certification label on the driver's doorjamb <sup>6</sup>

- \*1: Except 2.0 L engine models
- \*2: 2.0 L engine models
- \*3: Continuously variable transmission models
- \*4: Manual transmission models
- \*5: Right-hand drive type
- \*6: Left-hand drive type
- \*7: Models with rear fog light
- \*8: Models without rear fog light

## Engine Specifications

Type	Water-cooled in-line 3-cylinder DOHC <sup>1</sup>
	Water-cooled in-line 4-cylinder DOHC <sup>2, *3</sup>
Bore × Stroke	73.0 × 78.7 mm (2.87 × 3.10 in) <sup>1</sup>
	73.0 × 89.5 mm (2.87 × 3.52 in) <sup>2</sup>
	86.0 × 85.9 mm (3.39 × 3.38 in) <sup>3</sup>
Displacement	988 cm <sup>3</sup> (60.3 cu-in) <sup>1</sup>
	1,498 cm <sup>3</sup> (91.4 cu-in) <sup>2</sup>
	1,996 cm <sup>3</sup> (121.8 cu-in) <sup>3</sup>
Compression Ratio	10.0 : 1 <sup>1</sup>
	10.6 : 1 <sup>2</sup>
	9.8 : 1 <sup>3</sup>
Spark Plugs	NGK ILZKAR8H8S

- \*1: 1.0 L engine models
- \*2: 1.5 L engine models
- \*3: 2.0 L engine models

## Fuel

Type	Unleaded premium petrol/gasohol up to E10 (90% petrol and 10% ethanol), Research octane number 95 or higher <sup>1, *2</sup>
	Unleaded premium petrol, Research octane number of 95 or higher <sup>3</sup>
Fuel Tank Capacity	46.9 L (10.3 Imp gal)

- \*1: 1.0 L and 1.5 L engine models
- \*2: 2.0 L engine models with rear fog light
- \*3: Models without rear fog light

## Battery

Capacity	48AH(5)60AH(20)
----------	-----------------

### Idle Stop:

The battery installed in this vehicle is specifically designed for a model with Auto Idle Stop. If you need to replace the battery, make sure to select the specified type (L2). Ask a dealer for more details.

## Washer Fluid

Tank Capacity	3.0 L (2.6 Imp qt) <sup>1</sup>
	3.5 L (3.1 Imp qt) <sup>2</sup>
	2.5 L (2.2 Imp qt) <sup>3</sup>

- \*1: 2.0 L engine models
- \*2: Except 2.0 L engine models with headlight washers
- \*3: Except 2.0 L engine models without headlight washers

■ **Light Bulbs**

Headlights (Low Beam)	LED
Headlights (High Beam)	LED
Front Fog Lights*	LED
Front Turn Signal Lights	LED
Front Side Marker Lights*	5 W (Amber)
Position/Daytime Running Lights	LED
Side Turn Signal Lights	LED* <sup>1</sup> 5 W (Amber)* <sup>2</sup>
Brake Lights	21 W
Taillights	LED
Rear Turn Signal Lights	21 W (Amber)
Back-Up Lights	16 W
Rear Fog Light*	LED
High-Mount Brake Light	LED
Rear Licence Plate Light	LED
Interior Lights	
Map Lights	8 W
Ceiling Light	8 W
Vanity Mirror Lights*	2 W
Centre Pocket Lights*	LED
Luggage Area Light	5 W
Glove Box Light*	3.4 W

\*1: Door mirror type models  
\*2: Fender type models

■ **Air Conditioning\***

Refrigerant Type	HFO-1234yf (R-1234yf) <sup>1</sup> HFC-134a (R-134a)* <sup>2</sup>
Charge Quantity	375 - 425 g <sup>1</sup> 435 - 485 g <sup>2</sup>

\*1: Models with rear fog light  
\*2: Models without rear fog light

■ **Brake/Clutch\* Fluid**

Specified	Brake Fluid with DOT 3 or DOT 4
-----------	---------------------------------

■ **Continuously Variable Transmission Fluid\***

Specified	Honda HCF-2	
Capacity	Change	3.4 L (3.0 Imp qt) <sup>1</sup> 3.7 L (3.3 Imp qt) <sup>2</sup>

\*1: 1.0 L engine models  
\*2: 1.5 L engine models

■ **Manual Transmission Fluid\***

Specified	Honda MTF	
Capacity	Change	1.9 L (1.7 Imp qt) <sup>1</sup> 2.2 L (1.9 Imp qt) <sup>2</sup>

\*1: Except 2.0 L engine models  
\*2: 2.0 L engine models

■ **Engine Oil**

	<b>European and Ukrainian models</b>	
	Honda Genuine Engine Oil Type 2.0 ACEA C2/C3 0W-30, 5W-30, 10W-30	
	<b>Except European and Ukrainian models without gasoline particulate filter</b>	
Recommended	Honda Genuine Motor Oil 0W-20, 0W-30, 5W-30, 10W-30 ACEA A5/B5, API service SM or higher grade 0W-20, 0W-30, 5W-30, 10W-30	
	<b>Except European and Ukrainian models with gasoline particulate filter</b>	
	Honda Genuine Motor Oil 0W-20 ACEA C2/C3 0W-30, 5W-30, 10W-30	
	3.5 L (3.1 Imp qt) <sup>1</sup>	
	Change	3.2 L (2.8 Imp qt) <sup>2</sup> 5.0 L (4.4 Imp qt) <sup>3</sup>
Capacity		3.8 L (3.3 Imp qt) <sup>1</sup>
	Change including filter	3.5 L (3.1 Imp qt) <sup>2</sup> 5.4 L (4.8 Imp qt) <sup>3</sup>

\*1: 1.0 L engine models  
\*2: 1.5 L engine models  
\*3: 2.0 L engine models

Refer to the following page to determine whether your vehicle is equipped with a gasoline particulate filter.

➤ **Recommended Engine Oil P. 687**

\* Not available on all models

### ■ Engine Coolant

Specified	Honda All Season Antifreeze/Coolant Type 2
Ratio	50/50 with distilled water

#### 1.0 L engine models

6.05 L (1.33 Imp gal)<sup>\*1</sup>  
 (change including the remaining 0.745 L  
 (0.164 Imp gal) in the reserve tank)  
 5.83 L (1.28 Imp gal)<sup>\*2</sup>  
 (change including the remaining 0.745 L  
 (0.164 Imp gal) in the reserve tank)

#### 1.5 L engine models

Capacity  
 4.92 L (1.08 Imp gal)<sup>\*1</sup>  
 (change including the remaining 0.58 L (0.13  
 Imp gal) in the reserve tank)  
 4.84 L (1.06 Imp gal)<sup>\*2</sup>  
 (change including the remaining 0.58 L (0.13  
 Imp gal) in the reserve tank)

#### 2.0 L engine models

4.65 L (1.02 Imp gal)<sup>\*3</sup>  
 (change including the remaining 0.75 L (0.17  
 Imp gal) in the reserve tank)  
 4.64 L (1.02 Imp gal)<sup>\*4</sup>  
 (change including the remaining 0.75 L (0.17  
 Imp gal) in the reserve tank)

\*1: Continuously variable transmission models

\*2: Manual transmission models

\*3: Right-hand drive type

\*4: Left-hand drive type

### ■ Tyre

Regular	Size	215/55R16 93V <sup>*1</sup>
		235/45R17 94W <sup>*2</sup>
		245/35ZR19 93Y <sup>*3</sup>
Pressure	See the label on driver's doorjamb	

Compact Spare <sup>*</sup>	Size	T125/80D16 97M <sup>*1, *2</sup>
		T125/70R18 99M <sup>*3, *4</sup>
Pressure	See the label on driver's doorjamb	

Wheel Size	Regular	16 × 7J <sup>*1</sup>
		17 × 8J <sup>*2</sup>
		19 × 8 1/2J <sup>*3</sup>
		20 × 8 1/2J <sup>*4</sup>
Compact Spare <sup>*</sup>	16 × 4T <sup>*1, *2</sup>	
	18 × 4T <sup>*3, *4</sup>	

\*1: Models with 16 inch wheel

\*2: Models with 17 inch wheel

\*3: Models with 19 inch wheel

\*4: Models with 20 inch wheel

### ■ Honda TRK Air Compressor

A weighted emission sound pressure level	75 dB (A)
A weighted sound power level	95 dB (A)

### ■ Brake

Type	Power assisted
Front	Ventilated disc
Rear	Solid disc
Parking	Electric parking brake system

### ■ Vehicle Dimensions

#### 1.0 L and 1.5 L engine models

Length	4,518 mm (177.9 in)	
Width	1,799 mm (70.8 in)	
Height	1,428 mm (56.2 in)	
Wheelbase	2,697 mm (106.2 in)	
Track	Front	1,547 mm (60.9 in) <sup>*1</sup>
	Rear	1,537 mm (60.5 in) <sup>*2</sup>
Track	Front	1,563 mm (61.5 in) <sup>*1</sup>
	Rear	1,553 mm (61.1 in) <sup>*2</sup>

\*1: Models with 16 inch wheel

\*2: Models with 17 inch wheel

#### 2.0 L engine models

Length	4,557 mm (179.4 in)	
Width	1,877 mm (73.9 in)	
Height	1,427 mm (56.2 in) <sup>*1</sup>	
	1,434 mm (56.5 in) <sup>*2</sup>	
Wheelbase	2,699 mm (106.3 in)	
Track	Front	1,599 mm (63.0 in)
	Rear	1,602 mm (63.1 in)

\*1: Models with rear fog light

\*2: Models without rear fog light

1.0 L engine models with climate control system

■ The mounting point/rear over hang of coupling device\*1

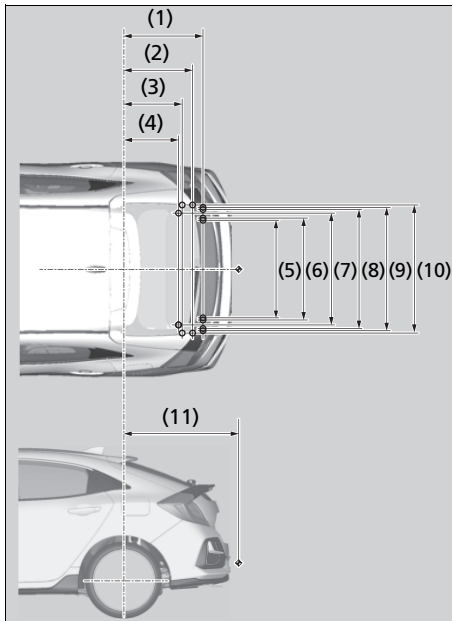

NOTE:

1. ○ marks show towbar fixing points.
2. ↗ mark shows towbar coupling point.

\*1: Except Tunisian models

No.	Dimensions
(1)	667 mm (26.3 in)
(2)	582 mm (22.9 in)
(3)	497 mm (19.6 in)
(4)	467 mm (18.4 in)
(5)	915 mm (36.0 in)
(6)	925 mm (36.4 in)
(7)	985 mm (38.8 in)
(8)	1,045 mm (41.1 in)
(9)	1,055 mm (41.5 in)
(10)	1,078 mm (42.4 in)
(11)	983 mm (38.7 in)

1.0 L engine models with climate control system

■ Max. Towing Weight\*1

Trailer with brakes	Manual Transmission Models	1,200 kg (2,646 lbs)
	Continuously variable transmission models	800 kg (1,764 lbs)
Trailer without brakes		500 kg (1,102 lbs)
The maximum permissible vertical load on the coupling device		75 kg (165 lbs)

\*1: Except Tunisian models

## Identification Numbers

### Vehicle Identification Number (VIN), Engine Number and Transmission Number

Your vehicle has a 17-digit vehicle identification number (VIN) used to register your vehicle for warranty purposes, and for licensing and insuring your vehicle.

The locations of your vehicle's VIN, engine number and transmission number are shown as follows.

#### Vehicle Identification Number (VIN), Engine Number and Transmission Number

The interior vehicle identification number (VIN) is located under the cover.

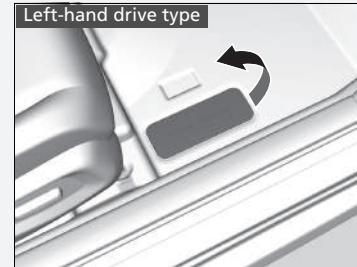
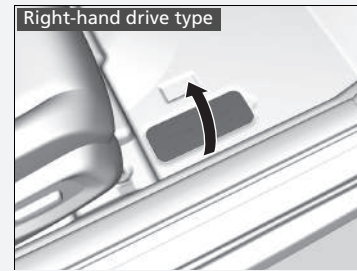



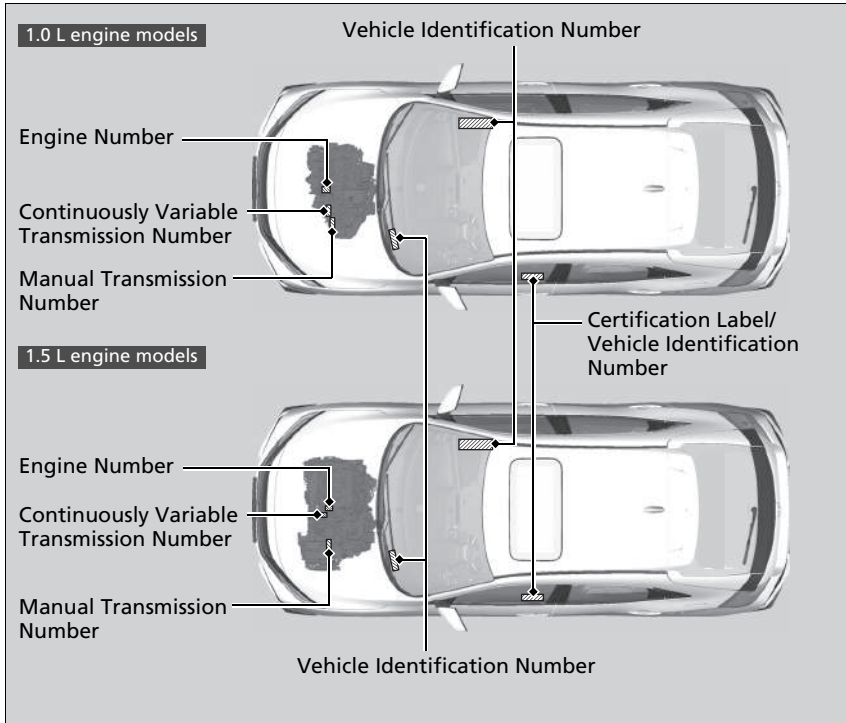

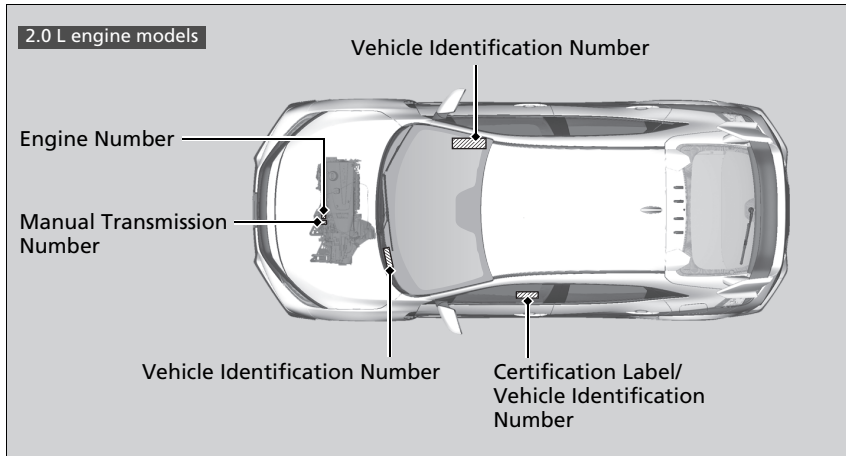

# Devices that Emit Radio Waves\*

The following products and systems on your vehicle emit radio waves when in operation.

## Remote Transmitter\* Immobilizer System

**KVALITET**  
 Akcionarsko društvo za ispitivanje kvaliteta "KVALITET" NE  
 Акционарско друштво за испитивање квалитета "КВАЛИТЕТ" НЕ  
 Joint-stock company for quality testing "KVALITET" NE

**POTVRDA O USAGLAŠENOSTI - RITTO** Broj: P1617162800  
**CONFIRMATION OF CONFORMITY - RITTE** No: P1617162800

**Potrošač/zahvat:** DELTA AUTOMOTO D.O.O.  
 Applicant: 11070 NOVI BEOGRAD  
 OMLADINSKI BREGADA 33A

**Vrsta opreme:** KLJUČNA DALJINSKI PRISTUP VOZILU  
 Equipment category:

**Oznaka tipa/modela:** HLK8-1R  
 Equipment type/model:

**Robna marka:** HondaLock  
 Equipment trademark:

**Proizvođač:** HondaLock Mfg. Co., Ltd.  
 Manufacturer: Japan

**Vredovna dokumentacija:** Evaluated documentation:  
**Laboratoriji/** Sushien/Safety, U.S. Japan, Inc. Head Office EMC Lab.  
**ispitni uredi:** 100003048, 01.07.2013.  
 Laboratory: 100000202, 24.06.2013. /  
**Test report:** BSW/EMC, U.S. Japan, Inc. SHONAN EMC Lab.  
 100000202, 15.06.2013. /  
 RITTO&TTE, U.S. Japan, Inc. SHONAN EMC Lab.  
 10000202A, 21.06.2013. /

**Međo i datum izdavanja:** Valido: 01.11.2013.  
 Place and date: 01.11.2013.

**Generalni direktor:** [Signature]  
 Vlasnik/vlastnikove, opt.jmb.

Ovaj dokument važi samo za proizvode koji su proširivši ka proizvodima koji su bili predmet vrednovanja.  
 But: Sving Care Konstantina 82-86, Nis 18000, Srbija. Tel: 0181820-769, 590-624. Fax: 0181820-436, 590-068  
 e-mail: ofis@kvalitet.co.rs, http://www.kvalitet.co.rs

Serbian models

**KVALITET**  
 Akcionarsko društvo za ispitivanje kvaliteta "KVALITET" NE  
 Акционарско друштво за испитивање квалитета "КВАЛИТЕТ" НЕ  
 Joint-stock company for quality testing "KVALITET" NE

**POTVRDA O USAGLAŠENOSTI - RITTO** Broj: P1617162900  
**CONFIRMATION OF CONFORMITY - RITTE** No: P1617162900

**Potrošač/zahvat:** DELTA AUTOMOTO D.O.O.  
 Applicant: 11070 NOVI BEOGRAD  
 OMLADINSKI BREGADA 33A

**Vrsta opreme:** UREĐAJ ZA BLOKADU KONTAKTA BRAVE VOZILA  
 Equipment category:

**Oznaka tipa/modela:** HLK8-1R  
 Equipment type/model:

**Robna marka:** HondaLock  
 Equipment trademark:

**Proizvođač:** HondaLock Mfg. Co., Ltd.  
 Manufacturer: Japan

**Vredovna dokumentacija:** Evaluated documentation:  
**Laboratoriji/** Sushien/Safety, U.S. Japan, Inc. Head Office EMC Lab.  
**ispitni uredi:** 100003048-02-6, 20.02.2013.  
 Laboratory: BSW/EMC, U.S. Japan, Inc. SHONAN EMC Lab.  
**Test report:** 100000202, 15.06.2013. /  
 RITTO&TTE, U.S. Japan, Inc. SHONAN EMC Lab.  
 100000202, 15.06.2013. /  
 10000202A-02-6, 15.01.2013. /

**Međo i datum izdavanja:** Valido: 01.11.2013.  
 Place and date: 01.11.2013.

**Generalni direktor:** [Signature]  
 Vlasnik/vlastnikove, opt.jmb.

Ovaj dokument važi samo za proizvode koji su proširivši ka proizvodima koji su bili predmet vrednovanja.  
 But: Sving Care Konstantina 82-86, Nis 18000, Srbija. Tel: 0181820-769, 590-624. Fax: 0181820-436, 590-068  
 e-mail: ofis@kvalitet.co.rs, http://www.kvalitet.co.rs

Information

Moroccan models  
 AGREE PAR L'ANRT MAROC  
 Numéro d'agrément: MR 8359 ANRT 2013  
 Date d'agrément: 19/07/2013

AGREE PAR L'ANRT MAROC  
 Numéro d'agrément: MR 8091 ANRT 2013  
 Date d'agrément: 25/04/2013

\* Not available on all models

**BCM** **FOB**  
**Keyless Access System\*** **Keyless Access System\***

**KVALITET**  
 Akcionarsko društvo za ispitivanje kvaliteta "KVALITET" NIS  
 Акционарско друштво за истраживање квалитета "КВАЛИТЕТ" Ниш  
 Joint-stock company for quality testing "KVALITET" NIS

**POTVRDA O USAGLAŠENOSTI - RITTO** Broj: **P1618079800**  
 CONFIRMATION OF CONFORMITY - R3TTE No. **P1618079800**

**Podnositelj zahteva:** RTTE CONSULTING DOO  
 Applicant: 11000 BEOGRAD  
 KNEZA VISELSKAVA 63/2.7

**Vrsta opreme:** KONTROLNI MODUL  
 Equipment category:

**Oznaka tipa/modela:** 40737300  
 Equipment type/model:

**Robna marka:** Continental  
 Equipment trademark:  
**Proizvođač:** Continental Automotive GmbH  
 Manufacturer: NEMAČKA

**Vrednovana dokumentacija:** Evaluated documentation:  
**Laboratorij/** Bežbežnost/Safety: CSA Group Bayern GmbH  
**Ispitni izveštaj/** 13020446\_02\_11\_2012 /  
**Laboratorij/** EMKEZAC: CSA Group Bayern GmbH  
**Test report:** T39211004LUP\_08.03.2015 /  
**Test report:** RITTO/RITTE: CSA Group Bayern GmbH  
 T39211004LUP\_08.03.2015 /

Niš potvrđuje navedenu dokumentaciju utvrđeno je da gore navedena oprema zadovoljava zahtev: Pravilnik o radio opremi i telekomunikacionoj terminalnoj opremi (G. Glavnik RG, 1/2012).  
 On the basis of the above mentioned documentation it is found that above mentioned equipment fulfils the requirements of the Rulesbook on Radio Equipment and Telecommunication Terminal Equipment (Official Gazette RG, 1/2012).  
 Nastale promene u specifikaciji, ispućnostima, komponentama, elektrićnim karakteristikama opreme koji uću na usaglašenost sa navedenom Pravilnikom moraju se prijaviti "Kvalitet" u s.d. Niš.  
 Any changes occur in the specification, specifications, components of the device, electrical characteristics which may influence on conformity to the above mention Rulesbook, shall be forwarded to "Kvalitet".  
 Priloženo izdavanje Potvrde za navedenu opremu: 15.05.2015. broj Potvrde: P1618079800

**Mesto i datum izdavanja:** Niš, 11.05.2015. **Valjiti do:** 10.05.2021.  
 Place and date: Niš, 11.05.2015. **Valid until:** 10.05.2021.

**Generalni direktor:**  
 Vladeimir Vučićević, dipl.ing.

Ovaj dokument važi samo za proizvode koji su predmet vrednovanja  
 This document is valid only for products which are subject of evaluation  
 Бул. Београдска Користанова Београд, Ниш, 18000, Србија. Тел: 010/650-760, 604-024. Факс: 010/650-040, 500-068  
 e-mail: office@kvalitet.co.rs, http://www.kvalitet.co.rs

**KVALITET**  
 Akcionarsko društvo za ispitivanje kvaliteta "KVALITET" NIS  
 Акционарско друштво за истраживање квалитета "КВАЛИТЕТ" Ниш  
 Joint-stock company for quality testing "KVALITET" NIS

**POTVRDA O USAGLAŠENOSTI - RITTO** Broj: **P1617072200**  
 CONFIRMATION OF CONFORMITY - R3TTE No. **P1617072200**

**Podnositelj zahteva:** RTTE CONSULTING DOO  
 Applicant: 11000 BEOGRAD  
 MARICKA 2629

**Vrsta opreme:** KLJUČ ZA DALJINSKI PRISTUP VOZILU  
 Equipment category:

**Oznaka tipa/modela:** V2x/V4x  
 Equipment type/model:

**Robna marka:** Continental  
 Equipment trademark:  
**Proizvođač:** Continental Automotive GmbH  
 Manufacturer: Germany

**Vrednovana dokumentacija:** Evaluated documentation:  
**Laboratorij/** Bežbežnost/Safety: M. Dudek Hořofrequency-Technik  
**Ispitni izveštaj/** 13020446\_02\_11\_2012 /  
**Laboratorij/** EMKEZAC: M. Dudek Hořofrequency-Technik  
**Test report:** 13020446\_02\_11\_2012 /  
**Test report:** RITTO/RITTE: M. Dudek Hořofrequency-Technik  
 13020446\_02\_11\_2012 /  
 13020446\_02\_11\_2012 /

Niš potvrđuje navedenu dokumentaciju utvrđeno je da gore navedena oprema zadovoljava zahtev: Pravilnik o radio opremi i telekomunikacionoj terminalnoj opremi (G. Glavnik RG, 1/2012).  
 On the basis of the above mentioned documentation it is found that above mentioned equipment fulfils the requirements of the Rulesbook on Radio Equipment and Telecommunication Terminal Equipment (Official Gazette RG, 1/2012).  
 Nastale promene u specifikaciji, ispućnostima, komponentama, elektrićnim karakteristikama opreme koji uću na usaglašenost sa navedenom Pravilnikom moraju se prijaviti "Kvalitet" u s.d. Niš.  
 Any changes occur in the specification, specifications, components of the device, electrical construction which may influence on conformity to the above mention Rulesbook, shall be forwarded to "Kvalitet".  
 Priloženo izdavanje Potvrde za navedenu opremu: 16.05.2014. broj Potvrde: P1614053300

**Mesto i datum izdavanja:** Niš, 12.05.2017. **Valjiti do:** 11.05.2020.  
 Place and date: Niš, 12.05.2017. **Valid until:** 11.05.2020.

**Generalni direktor:**  
 Vladeimir Vučićević, dipl.ing.

Ovaj dokument važi samo za proizvode koji su predmet vrednovanja  
 This document is valid only for products which are subject of evaluation  
 Бул. Београдска Користанова Београд, Ниш, 18000, Србија. Тел: 010/650-760, 604-024. Факс: 010/650-040, 500-068  
 e-mail: office@kvalitet.co.rs, http://www.kvalitet.co.rs

Serbian models

Moroccan models  
 AGREE PAR L'ANRT MAROC  
 Numéro d'agrément: MR 10384 ANRT 2015  
 Date d'agrément: 14/05/2015

Moroccan models  
 AGREE PAR L'ANRT MAROC  
 Numéro d'agrément: MR 8478 ANRT 2013  
 Date d'agrément: 24/09/2013

Hands-Free Telephone System\* (Models with display audio)

Hands-Free Telephone System\* (Models with colour audio)

**KVALITET** Asociaciono društvo za ispitivanje kvaliteta "KVALITET" NE  
 Ассоцијационо друштво за испитивање квалитета "КВАЛИТЕТ" НЕ  
 Joint-stock company for quality testing "KVALITET" NE

**POTVRDA O USAGLAŠENOSTI - RITTE** Broj: P1618123900  
 CONFIRMATION OF CONFORMITY - RITTE No:

Podnositelj zahteva: RITTE CONSULTING DOO Aplikant: 11000 BEOGRAD-RAKOVIČA  
 KNEŽA VRSBAVLJA, 832/2

Vrsta opreme: AUDIO UREĐAJ ZA AUTOMOBIL  
 Equipment category:

Oznaka tipa/modela: NR-000  
 Equipment type/model:

Robna marka: MITSUBISHI  
 Equipment trade name:  
 Proizvođač: Mitsubishi Electric Corporation Sanda Works  
 Manufacturer: JAPAN

**Vidovna dokumentacija** Evaluated documentation:  
 Brodovi certifikati: J2, Japan, No. Iss: EMC Lab:  
 Ispitni izveštaji: 10706944-A-18, 08.2015. /  
 EN62321, U.S. Japan, No. Iss: EMC Lab:  
 Laboratorij: 10706944-A-0, 24.08.2015. /  
 Test report: RITTE CONSULTING, U.S. Japan, No. Iss: EMC Lab:  
 10706944-C, 24.08.2015. /  
 10706944-E, 24.08.2015. /  
 10706944-H, 24.08.2015. /  
 10706944-D, 24.08.2015. /  
 10706944-Z, 24.08.2015. /  
 10706944-F, 24.08.2015. /

**Na osnovu gore navedene dokumentacije utvrđeno je da gore navedena oprema zadovoljava zahtev "Priloga B u rezi-  
 operativni funkcionisanje termoplastični materijal" (Priloga B, članak 192, 192(2)).**  
 On the basis of the above mentioned documentation it is found that above mentioned equipment fulfils the requirements of the "Rubric B in  
 Parts Equipment and Telecommunications Termoplastični materijal" (Priloga B, članak 192, 192(2)).

**Navedena oprema u specifikaciji, ispitivanju, homologovanju, sertifikovanju i izdavanju potvrda opreme koja uključuje ne usaglašavanje  
 sa navedenom Prilozikom mora se prijaviti "Kvalitet" a.d. u.B.**  
 The equipment specified in the specification, certification, homologation, certification and issuance of certificates which may influence on conformity to the  
 above mentioned Rubric, shall be forwarded to "Kvalitet".

Preko izdavanja Potvrda za usaglašenost: 11.09.2015. P1618123900  
 Through issuance of certificates of conformity: 11.09.2015. P1618123900

Mesto i datum izdavanja: Vrb: 02. /  
 Place and date: Vrb: 02. /  
 No.: 02.08.2015. / 02.08.2015.

Čuvaj dokumenti saš samo za potrebe tog ili tihovih ili proizvodnja tog su ili proizvodnja  
 Bul. Sveng Cara Kneževina 82-08, No. 18300, Brijuni, Tel: 0718 050 156, 150-424, Fax: 0718 883-636, 550-090  
 e-mail: office@kvalitet.rs, http://www.kvalitet.rs

Serbian models

Ovim, Panasonic, deklariše da je BH1601  
 u skladu sa osnovnim zahtevima i ostalim relevantnim odredbama  
 Direktive 1999/5/EC.

**KVALITET** Asociaciono društvo za ispitivanje kvaliteta "KVALITET" NE  
 Ассоцијационо друштво за испитивање квалитета "КВАЛИТЕТ" НЕ  
 Joint-stock company for quality testing "KVALITET" NE

**POTVRDA O USAGLAŠENOSTI - RITTE** Broj: P1618134500  
 CONFIRMATION OF CONFORMITY - RITTE No:

Podnositelj zahteva: RITTE CONSULTING DOO Aplikant: 11000 BEOGRAD-RAKOVIČA  
 KNEŽA VRSBAVLJA, 832/2

Vrsta opreme: AUDIO UREĐAJ ZA AUTOMOBIL  
 Equipment category:

Oznaka tipa/modela: BH1601  
 Equipment type/model:

Robna marka: PANASONIC  
 Equipment trade name:  
 Proizvođač: PANASONIC CORPORATION AUTOMOTIVE & INDUSTRIAL SYSTEMS COMPANY  
 Manufacturer: JAPAN

**Vidovna dokumentacija** Evaluated documentation:  
 Brodovi certifikati: J2, Japan, No. Iss: EMC Lab:  
 Ispitni izveštaji: 10500005, 08.06.2015. /  
 Laboratorij: DARTTECH ANDOCO, FRANCE  
 Test report: RITTE CONSULTING, U.S. Japan, No. Iss: EMC Lab:  
 10500005, 08.06.2015. /  
 10500005, 08.06.2015. /  
 10500005, 08.06.2015. /  
 10500005, 08.06.2015. /  
 10500005, 08.06.2015. /  
 10500005, 08.06.2015. /  
 10500005, 08.06.2015. /

**Na osnovu gore navedene dokumentacije utvrđeno je da gore navedena oprema zadovoljava zahtev "Priloga B u rezi-  
 operativni funkcionisanje termoplastični materijal" (Priloga B, članak 192, 192(2)).**  
 On the basis of the above mentioned documentation it is found that above mentioned equipment fulfils the requirements of the "Rubric B in  
 Parts Equipment and Telecommunications Termoplastični materijal" (Priloga B, članak 192, 192(2)).

**Navedena oprema u specifikaciji, ispitivanju, homologovanju, sertifikovanju i izdavanju potvrda opreme koja uključuje ne usaglašavanje  
 sa navedenom Prilozikom mora se prijaviti "Kvalitet" a.d. u.B.**  
 The equipment specified in the specification, certification, homologation, certification and issuance of certificates which may influence on conformity to the  
 above mentioned Rubric, shall be forwarded to "Kvalitet".

Preko izdavanja Potvrda za usaglašenost: 07.08.2015. Broj: P1618134500  
 Through issuance of certificates of conformity: 07.08.2015. Broj: P1618134500

Mesto i datum izdavanja: Vrb: 02. /  
 Place and date: Vrb: 02. /  
 No.: 02.08.2015. / 02.08.2015.

Čuvaj dokumenti saš samo za potrebe tog ili tihovih ili proizvodnja tog su ili proizvodnja  
 Bul. Sveng Cara Kneževina 82-08, No. 18300, Brijuni, Tel: 0718 050 156, 150-424, Fax: 0718 883-636, 550-090  
 e-mail: office@kvalitet.rs, http://www.kvalitet.rs

Moroccan  
 models

AGREE PAR L'ANRT MAROC  
 Numéro d'agrément: MR 10932 ANRT 2015  
 Date d'agrément: 2015/10/8

AGREE PAR L'ANRT MAROC  
 Numéro d'agrément: MR 8533 ANRT 2013  
 Date d'agrément: 23/10/2013

\* Not available on all models



Wireless Charger\*

Serbian models



W005 16

\* Not available on all models

Israeli models

Remote Transmitter\*/Immobilizer System

א. השימוש במכשיר הינו על בסיס "משני" ופטור מרשיון הפעלה אלחוטי. כלומר – לא מוגן מהפרעות וללא הפרעה למערכות אחרות הפועלות כדין.  
 ב. רק "בפעולת בוק" לשימוש עצמי של הלקוח בלבד, הציוד פטור מרשיון הפעלה אלחוטי. מתן "שרות בוק" לצד ג' מחייב רשיון מיוחד ממשרד התקשורת.  
 ג. אסור להחליף את האנטנה המקורית של המכשיר, ולא לעשות בו כל שינוי טכני אחר.

Keyless Access System\*

כי רשום יחיה בה, מדבקה יודבק המוצר של חיצונית אריזה שעל היבואן ידאג השיווק לפני אלחוטי הפעלה מרשיון ופטור "משני" בסיס על הינו במכשיר השימוש א.  
 כדין הפעלות אחרות למערכות הפרעה וללא מהפרעות מוגן לא – כלומר מרשיון פטור הציוד, בלבד הלקוח על עצמי לשימוש "בוק בפעולת" רק ב.  
 אלחוטי הפעלה.  
 התקשורת ממשרד מיוחד רשיון מחייב ג' לצד "בוק שרות" מתן  
 אחר טכני שינוי כי בו לעשות ולא, המכשיר של המקורית האנטנה את להחליף אסור ג.

Hands-Free Telephone System\* (Models with display audio)

א. נקודות הגישה תחיה מיועדת אך ורק לחיבור משתמש המצוי בחצרים מתוחמים (דוגמת בית, בית עסק, מתחם שדה תעופה, קמפוס אוניברסיטאי וכו')  
 ב. לצורך גישה לאינטרנט, נקודת הגישה תקושר מחוץ לחצרים אך ורק אל בעל רישיון למתן שירות גישה לאינטרנט (ISP), להלן-ספק אינטרנט). הקישור לספק אינטרנט יהיה אך ורק באמצעות קו תקשורת נתונים המסופק בידי בעל רישיון למתן שירותי תקשורת  
 ג. קישור נקודת הגישה מחוץ לחצרים לצורך תקשורת נתונים ייעשה באמצעות תשתיות של בעל רישיון מתאים.  
 ד. לצורך שרות לצד ג' נדרש רישיון נוסף מאגף חנדסה ורשיון (משרד התקשורת).

Blind spot information System\*/Cross Traffic Monitor\*

א. השימוש במכשיר פטור מרשיון הפעלה אלחוטי, לא מוגן מהפרעות וללא הפרעה למערכות אחרות הפועלות כדין.  
 ב. רק "בפעולת בוק" לשימוש עצמי של הלקוח בלבד, הציוד פטור מרשיון הפעלה אלחוטי. מתן "שרות בוק" לצד ג' מחייב רשיון מיוחד ממשרד התקשורת.  
 ג. אסור להחליף את האנטנה המקורית של המכשיר, ולא לעשות בו כל שינוי טכני אחר.











Hands-Free Telephone System\* (Models with colour audio)

Adaptive Cruise Control (ACC) with Low Speed Follow\*/ Adaptive Cruise Control (ACC)\*/Collision Mitigation Braking System (CMBS)\*

מספר אישור אלחוטי של משרד התקשורת הוא 51-49855  
 אסור להחליף את האנטנה המקורית של המכשיר ולא לעשות בו כל שינוי טכני אחר

10. תאים מיוחדים והערות המערך:  
 Mid range Radar sensor for vehicles (MRR)  
 לפני השיווק ידאג היבואן שעל אריזה חיצונית של המוצר יודבק מדבקה, בה יחיה רשום מס.האישור וכן:  
 א. השימוש במכשיר הינו על בסיס "משני" ופטור מרשיון הפעלה אלחוטי. כלומר - לא מוגן מהפרעות וללא הפרעה למערכות אחרות הפועלות כדין.  
 ב. רק "בפעולת בוק" לשימוש עצמי של הלקוח בלבד, הציוד פטור מרשיון הפעלה אלחוטי. מתן "שרות בוק" לצד ג' מחייב רשיון מיוחד ממשרד התקשורת.  
 ג. אסור להחליף את האנטנה המקורית של המכשיר, ולא לעשות בו כל שינוי טכני אחר.



	Remote Transmitter*	Immobilizer System	Keyless Access System	Hands-Free Telephone System
South African models			FOB:  BCM: 	
Botswanan models	BOCRA BOCRA/TA/2019/1524	BOCRA BOCRA/TA/2019/1523	FOB: BOCRA BOCRA/TA/2018/944 BCM: BOCRA BOCRA/TA/2019/2322	BOCRA BOCRA/TA/2019/2219
Zambian models			FOB:  BCM: 	

Information

\* Not available on all models

### Immobilizer System

[http://www.hondalock.co.jp/ukr\\_doc/hlik6-1r\\_ukr.pdf](http://www.hondalock.co.jp/ukr_doc/hlik6-1r_ukr.pdf)

справжнім Honda Lock Mfg. Co., Ltd. заявляє, що радіобладнання типу HLIK6-1R відповідає статті 355 Закону України. Повний текст Української декларації про відповідність можна отримати за такою інтернет-адресою:  
[http://www.hondalock.co.jp/ukr\\_doc/hlik6-1r\\_ukr.pdf](http://www.hondalock.co.jp/ukr_doc/hlik6-1r_ukr.pdf)

Postal address:  
3700 Shimonaka, Sadowara-cho, Miyazaki-shi, Miyazaki,  
880-0293, Japan,

Ukrainian  
models

Manufacturer name:  
Honda Lock Mfg. Co., Ltd.

Operational frequency band:  
125 kHz

Maximum Output Power:  
148.8 dB $\mu$ V/m@3 m

Importer Name:  
Pride Motor LLC

Postal address:  
12, Sagaydachnogo Str., Kyiv, 04070, Ukraine

---

## Remote Transmitter\*

[http://www.hondalock.co.jp/ukr\\_doc/hlik6-3t\\_ukr.pdf](http://www.hondalock.co.jp/ukr_doc/hlik6-3t_ukr.pdf)

справжнім Honda Lock Mfg. Co., Ltd. заявляє, що радіобладнання типу HLIK6-3T відповідає статті 355 Закону України. Повний текст Української декларації про відповідність можна отримати за такою інтернет-адресою:  
[http://www.hondalock.co.jp/ukr\\_doc/hlik6-3t\\_ukr.pdf](http://www.hondalock.co.jp/ukr_doc/hlik6-3t_ukr.pdf)

Postal address:  
 3700 Shimonaka, Sadowara-cho, Miyazaki-shi, Miyazaki,  
 880-0293, Japan,

Ukrainian  
 models

Manufacturer name:  
 Honda Lock Mfg. Co., Ltd.

Operational frequency band:  
 433.87 - 433.97 MHz

Maximum Output Power:  
 10 mW (e.r.p.)

Importer Name:  
 Pride Motor LLC

Postal address:  
 12, Sagaydachnogo Str., Kyiv, 04070, Ukraine

Hands-Free Telephone System\* (Models with colour audio)

<https://service.panasonic.ua/>

справжнім Panasonic Corporation заявляє, що тип радіообладнання BH1601 відповідає Технічному регламенту радіообладнання; повний текст декларації про відповідність доступний на веб-сайті за такою адресою: <https://service.panasonic.ua/> (розділ «Технічне регулювання»)

моделі; BH1601

Postal address:  
4261 Ikonobe-cho, Tsuzuki-ku, Yokohama City, 224-8520, Japan

Manufacturer name:  
Panasonic Corporation

Ukrainian models

Operational frequency band:  
2402 - 2480 MHz

Maximum Output Power:  
2.5 mW

Importer Name:  
Pride Motor LLC

Postal address:  
12, Sagaydachnogo Str., Kyiv, 04070, Ukraine

**ДЕКЛАРАЦІЯ ПРО ВІДПОВІДНІСТЬ № RTS.UKR.355-70/18**

**1. Радіообладнання (виріб, тип, номер партії чи серійний номер):**  
Пристрій автомобільний мультимедійний торговельної марки Panasonic моделі BH1601 з об'єднаним радіодіагносту (інтерфейс передачі даних Bluetooth).

**2. Найменування та адреса виробника або його уповноваженого представника:**  
Уповноважений представник - ТОВ "Радио Тест Стандарт", Україна, 05115, м.Київ, вул. Львівська, 22-а, кв.135, код ЄДРПОУ 39203151 (Довірчість: "Panasonic Corporation" ("Panasonic Corporation"), Японія, від 30.01.2018).

**3. Ця декларація відповідності видана під особисту відповідальність виробника:**  
"Panasonic Corporation", 4261 Ikonobe-cho, Tsuzuki-ku, Yokohama City, 224-8520, Japan) ("Panasonic Corporation", 4261 Ikonobe-cho, Tsuzuki-ku, Yokohama City, 224-8520, Japan).

**4. Об'єкт декларації (ідентифікація радіообладнання, яка дає змогу забезпечити його простежуваність; може включати кольорове чітке зображення у разі потреби для ідентифікації зазначеного радіообладнання):**  
Пристрій автомобільний мультимедійний моделі BH1601 з об'єднаним радіодіагносту (інтерфейс передачі даних Bluetooth).

**5. Об'єкт декларації відповідає вимогам таких технічних регламентів:**  
Технічного регламенту радіообладнання;

**6. Посилання на відповідні стандарти з переліку національних стандартів, що були застосовані, або посилання на інші технічні специфікації, щодо яких декларується відповідність (з зазначенням ідентифікаційного номера, версії та дати видання):**

Пункт "Технічне регламенту радіообладнання"	Стандарт	Ім'я органу регулювання	Інформаційна лабораторія (зазначити адресу/адресу електронної пошти)
Застосовані стандарти, що включені до "Переліку національних стандартів, відповідність яким надає гарантію відповідності радіообладнання суттєвими аспектами"	-	-	-
п.6.1	-	-	-
Застосовані стандарти, що не включені до "Переліку національних стандартів, відповідність яким надає гарантію відповідності радіообладнання суттєвими аспектами"	-	-	-
п.6.1бан 1	ДСТУ EN 62368-1:2015 (зі змінами, Додаток В), ДСТУ EN 50385:2007	7486 від 28.09.2018	ВІЛ РІТ УЦЕНТР (21227)
п.6.1бан 2	ДСТУ EN 301 489-8:2014 (сл. 8.2, 5.2, 9.3) з урахуванням ДСТУ 4181 EN 301 489-17:2008	7486 від 28.09.2018	ВІЛ РІТ УЦЕНТР (21227)
п.7	ДСТУ ETSI EN 300 328:2008	7486 від 28.09.2018	ВІЛ РІТ УЦЕНТР (21227)

**7. Призначений орган з оцінки відповідності ДЕРЖАВНОГО ПІДПРИЄМСТВА "УКРАЇНСЬКИЙ НАУКОВО-ДОСЛІДНИЙ ІНСТИТУТ РАДІО І ТЕЛЕБІЧЕННЯ",**  
Регістраційний номер: UA.TR.028  
(назва/позначення, ідентифікаційний номер згідно з реєстром призначених органів)

ВІКОННИЙ ЕКСПЕРТНИЙ ЦЕНТР  
(своєю мовою/на мові дії)  
та видав сертифікат експертним змщу № 2187.7-СЕТ від 05.11.2018



**Hands-Free Telephone System\* (Models with display audio)**

[http://www.mitsubishielectric.com/bu/automotive/doc/ukr/nr-000\\_ukr.pdf](http://www.mitsubishielectric.com/bu/automotive/doc/ukr/nr-000_ukr.pdf)

справжнім [MITSUBISHI ELECTRIC CORPORATION SANDA WORKS] заявляє, що тип радіобладнання [NR-000] відповідає Технічному регламенту радіобладнання; повний текст декларації про відповідність доступний на веб-сайті за такою адресою: [[http://www.mitsubishielectric.com/bu/automotive/doc/ukr/nr-000\\_ukr.pdf](http://www.mitsubishielectric.com/bu/automotive/doc/ukr/nr-000_ukr.pdf)]

Postal address:  
2-3-33, Miwa, Sanda-city, Hyogo, 669-1513, Japan

Ukrainian models

Manufacturer name:  
Mitsubishi Electric Corporation

Operational frequency band:  
1574.42 - 1576.42 MHz  
2402 - 2480 MHz

Maximum Output Power:  
2.4 GHz: 12.15 dBm EIRP

Importer Name:  
Pride Motor LLC

Postal address:  
12, Sagaydachnogo Str., Kyiv, 04070, Ukraine

\* Not available on all models

Tuner\*

<https://service.panasonic.ua/>

справжнім Panasonic Corporation заявляє, що тип радіообладнання CR-LH55EFAE ,CR-LH55EBAE відповідає Технічному регламенту радіообладнання; повний текст декларації про відповідність доступний на веб-сайті за такою адресою:

<https://service.panasonic.ua/>  
(розділ «Технічне регулювання»)

моделі; CR-LH55EFAE ,CR-LH55EBAE „CR-LH55EGAE „CR-LH55EJAE

Postal address:  
4261 Ikonobe-cho, Tsuzuki-ku, Yokohama City, 224-8520, Japan

Manufacturer name:  
Panasonic Corporation

Importer Name:  
Pride Motor LLC

Postal address:  
12, Sagaydachnogo Str., Kyiv, 04070, Ukraine

Ukrainian models

Information

**ДЕКЛАРАЦІЯ ПРО ВІДПОВІДНІСТЬ № RTS.UKR.355-53/19**

**1. Радіообладнання (марка, тип, номер партії чи серійний номер):**  
Пристрій автомобільний мультимедійний торговельної марки **Panasonic** моделей **CQ-RH26R0FX, CR-LH55F3GX, CR-LH55F3FX, CR-LH55GETT, CR-LH55GGTT, CR-LH55EFAE, CR-LH55EGAE з FM/AM/DAB-приймачем.**

**2. Найменування та адреса виробника або його уповноваженого представника:**  
Уповноважений представник - ТОВ "Радіо Тест Стандарти", Україна, 03115, м. Київ, вул. Львівська, 22-а, к. 135, код ЄДРПОУ 39205151 (Довіреність "Panasonic Corporation" ("Panasonic Corporation"), Японія, від 30.01.2018).

**3. На декларації відповідності вказана під особливу відповідальність виробника:**  
"Panasonic Corporation", 4261 Ikonobe-cho, Tsuzuki-ku, Yokohama City, 224-8520, Японія) ("Panasonic Corporation", 4261 Ikonobe-cho, Tsuzuki-ku, Yokohama City, 224-8520, Japan).

**4. Об'єкт декларації (ідентифікаційне радіообладнання, яка дає змогу забезпечити його прослуховуваність); може включати кольорове чітке зображення у разі потреби для ідентифікації вказаного радіообладнання):**  
Пристрій автомобільний мультимедійний моделей **CQ-RH26R0FX, CR-LH55F3GX, CR-LH55F3FX, CR-LH55GETT, CR-LH55GGTT, CR-LH55EFAE, CR-LH55EGAE з FM/AM/DAB-приймачем.**

**5. Об'єкт декларації відповідає вимогам таких технічних регламентів:**  
Технічного регламенту радіообладнання;

**6. Нормативні акти (національні стандарти з переліку національних стандартів, що були застосовані, або вказати на інші технічні специфікації, щодо яких декларується відповідність (з вказанням ідентифікаційного номера, перей та дати видання):**

Пункт "Технічного регламенту радіообладнання"	Стандарт	Номер протоколу випробувань	Випробувальна лабораторія (включає акредитаційну інформацію)
Застосовані стандарти, що вказані до "Переліку національних стандартів, відповідність яким надає гарантію відповідності радіообладнання суттєво вищою"			
m.7			
Застосовані стандарти, що не вказані до "Переліку національних стандартів, відповідність яким надає гарантію відповідності радіообладнання суттєво вищою"			
m.4, абзац 1	ДСТУ EN 62368-1:2015 (відома Додаток F)	7482 від 20.09.2018	ВІЛ РІТ УНІЦРТ (38227)
m.4, абзац 2	ДСТУ EN 301 489-1:2014 (оп. 5.2, 5.2, 9.3) (з урахуванням ДСТУ EN 301 489-3:2009)	7482 від 20.09.2018	ВІЛ РІТ УНІЦРТ (38227)
m.7	ДСТУ EN 55012:2016 (ч. 4.6)	7482 від 20.09.2018	ВІЛ РІТ УНІЦРТ (38227)

**7. Призначений орган з оцінки відповідності ДЕРЖАВНОГО ПІДПРИЄМСТВА "УКРАЇНСЬКИЙ НАУКОВО-ДОСЛІДНИЙ ІНСТИТУТ РАДІО І ТЕЛЕБАЧЕННЯ"**  
Регістраційний номер: UA.TK.028  
(найменування, ідентифікаційний номер згідно з реєстром призначених органів)  
визнання **УКРАЇНСЬКИЙ УНІЦ**  
(опис визнанням или ДІІ)



Tuner\*

**ДЕКЛАРАЦІЯ ПРО ВІДПОВІДНІСТЬ № RTS.UKR.355-54/19**

**1. Раціоналізація (марк, тип, номер маркі чи серійний номер):**  
Пристрій автомобільної музично-радіоїної торгової марки Рамосікс моделі CR-LH55EAE, CQ-THE1E1AJ, CQ-THE1E1BU з FM/AM/DAB-привідом.

**2. Найменування та адреса виробника або його уповноваженого представника:**  
Уповноважений представник - ТОВ "Радіо Тест Стандард", Україна, 03115, м.Київ, вул. Лавинська, 22-а, к. 135, код ЄДРПОУ 39205151 (Довірчість "Панасонік Корпорейшн ("Panasonic Corporation)", Японія, від 30.01.2018).

**3. На декларанті відповідності вказано нія особисту відповідальність виробника:**  
"Панасонік Корпорейшн", 4261 Йокосе-чо, Цукуші-ку, Йокосама Сіті, 224-8520, Японія) ("Panasonic Corporation", 4261 Yokoshe-cho, Tsuzuki-ku, Yokohama City, 224-8520, Japan).

**4. Об'єкт декларації (ідентифікаційне радіобладиння, яка дає змогу забезпечити його протекуючість; може включати кольорове чітке зображення у разі потреби для ідентифікації вказаного радіобладиння):**  
Пристрій автомобільної музично-радіоїної торгової марки Рамосікс моделі CR-LH55EAE, CQ-THE1E1AJ, CQ-THE1E1BU з FM/AM/DAB-привідом.

**5. Об'єкт декларації відповідає вимогам таких технічних регламентів:**  
Технічного регламенту радіобладиння;

**6. Посилання на відповідні стандарти з переліку національних стандартів, що були застосовані, або посилання на інші технічні специфікації, якщо вони декларуються відповідність (із зазначенням ідентифікаційного номера, версії та дати виходу):**

Пункт "Технічного регламенту радіобладиння"	Стандарт	Номер протоколу випробувань	Випробувальна лабораторія (станція передачі/власник інформації)
Зазначені стандарти, що включені до "Переліку національних стандартів, відповідність яких надає гарантію відповідності радіобладиння суцільному сигналу"	-	-	-
a.7	-	-	-
Зазначені стандарти, що не включені до "Переліку національних стандартів, відповідність яких надає гарантію відповідності радіобладиння суцільному сигналу"	-	-	-
a.4, об'єкт 1	ДСТУ EN 62368-1:2018 (зі змінами Додаток F)	7484 від 20.09.2018	ВІЛ РІТ УЗІДПРТ (08227)
a.4, об'єкт 2	ДСТУ EN 301 489-1:2014 (зм. 5.1, 5.2, 5.3) (з урахуванням ДСТУ ЕТІВ EN 301 489-3:2009)	7484 від 20.09.2018	ВІЛ РІТ УЗІДПРТ (08227)
a.7	ДСТУ EN 55032:2016 (з. 4.6)	7484 від 20.09.2018	ВІЛ РІТ УЗІДПРТ (08227)

**7. Призначений орган з оцінки відповідності ДЕРЖАВНОГО ПІДПРИЄМСТВА "УКРАЇНСЬКИЙ НАУКОВО-ДОСЛІДНИЙ ІНСТИТУТ РАДІО І ТЕЛЕБачЕННЯ",**  
Регістраційний номер: UA.TR.028

випробування, ідентифікаційний номер згідно з розпорядженням органу) (запис випробувань згідно з ДСТУ)  
та видає сертифікат експорту типу № 2187.5-СЕТ від 14.11.2018 з Додатком 1.1 від 19.12.2018 та Додатком 1.2 від 04.04.2019



Ukrainian models

**ДЕКЛАРАЦІЯ ПРО ВІДПОВІДНІСТЬ № RTS.UKR.355-68/18**

**1. Раціоналізація (марк, тип, номер маркі чи серійний номер):**  
Пристрій автомобільної музично-радіоїної торгової марки Рамосікс моделі CR-LH55EAE, CQ-THE1E1AJ, CQ-THE1E1BU з FM/AM/DAB-привідом.

**2. Найменування та адреса виробника або його уповноваженого представника:**  
Уповноважений представник - ТОВ "Радіо Тест Стандард", Україна, 03115, м.Київ, вул. Лавинська, 22-а, к. 135, код ЄДРПОУ 39205151 (Довірчість "Панасонік Корпорейшн ("Panasonic Corporation)", Японія, від 30.01.2018).

**3. На декларанті відповідності вказано нія особисту відповідальність виробника:**  
"Панасонік Корпорейшн", 4261 Йокосе-чо, Цукуші-ку, Йокосама Сіті, 224-8520, Японія) ("Panasonic Corporation", 4261 Yokoshe-cho, Tsuzuki-ku, Yokohama City, 224-8520, Japan).

**4. Об'єкт декларації (ідентифікаційне радіобладиння, яка дає змогу забезпечити його протекуючість; може включати кольорове чітке зображення у разі потреби для ідентифікації вказаного радіобладиння):**  
Пристрій автомобільної музично-радіоїної моделі CR-LH55EAE, CQ-THE1E1AJ, CQ-THE1E1BU з FM/AM/DAB-привідом.

**5. Об'єкт декларації відповідає вимогам таких технічних регламентів:**  
Технічного регламенту радіобладиння;

**6. Посилання на відповідні стандарти з переліку національних стандартів, що були застосовані, або посилання на інші технічні специфікації, якщо вони декларуються відповідність (із зазначенням ідентифікаційного номера, версії та дати виходу):**

Пункт "Технічного регламенту радіобладиння"	Стандарт	Номер протоколу випробувань	Випробувальна лабораторія (станція передачі/власник інформації)
Зазначені стандарти, що включені до "Переліку національних стандартів, відповідність яких надає гарантію відповідності радіобладиння суцільному сигналу"	-	-	-
a.7	-	-	-
Зазначені стандарти, що не включені до "Переліку національних стандартів, відповідність яких надає гарантію відповідності радіобладиння суцільному сигналу"	-	-	-
a.4, об'єкт 1	ДСТУ EN 62368-1:2018 (зі змінами Додаток F)	7484 від 20.09.2018	ВІЛ РІТ УЗІДПРТ (08227)
a.4, об'єкт 2	ДСТУ EN 301 489-1:2014 (зм. 5.1, 5.2, 5.3) (з урахуванням ДСТУ ЕТІВ EN 301 489-3:2009)	7484 від 20.09.2018	ВІЛ РІТ УЗІДПРТ (08227)
a.7	ДСТУ EN 55032:2016 (з. 4.6)	7484 від 20.09.2018	ВІЛ РІТ УЗІДПРТ (08227)

**7. Призначений орган з оцінки відповідності ДЕРЖАВНОГО ПІДПРИЄМСТВА "УКРАЇНСЬКИЙ НАУКОВО-ДОСЛІДНИЙ ІНСТИТУТ РАДІО І ТЕЛЕБачЕННЯ",**  
Регістраційний номер: UA.TR.028

випробування, ідентифікаційний номер згідно з розпорядженням органу) (запис випробувань згідно з ДСТУ)  
та видає сертифікат експорту типу № 2187.5-СЕТ від 14.11.2018



Information

\* Not available on all models

# EC Declaration of Conformity Content Outline\*

**EC Declaration of Conformity** 

1. The undersigned, Mr. Ryoichi Hiraki, representing the manufacturers, herewith declares that the machinery described below fulfills all the relevant provisions of:

- The EC-directive 2006/42/EC on machinery

2. Description of the machinery

a) Generic denomination: Pantograph jack  
b) Function: lifting motor vehicle

c) Model	d) Type
SNB	Honda Type-A
SJD	Honda Type-B
SZA	Honda Type-C
SAH	Honda Type-D
TP6	Honda Type-G
TSA	Honda Type-I
T2V	Honda Type-J
TNY	Honda Type-K

3. Manufacturer (1) : Honda Type-A/B/C/G/L/K  
RIKENKAKI CO., LTD.  
6-6-12 Chiyoda Sakado-ohi,  
Saitama 350-0214  
JAPAN

4. Manufacturer (2) : Honda Type-D/J  
CHANGZHOU RIKENSEKO MACHINERY CO., LTD.  
No. 5 Xinlin Road, Zhonglou Changzhou,  
Jiangsu CHINA

5. Legal person authorised to compile the technical file :  
Honda Motor Europe Ltd Belgian Branch  
p/a Honda Motor Europe Ltd – Aalst Office  
Wijngaardveld 1 (Noord V1  
B-9300 Aalst (Belgium)

6. References to harmonized standards	7. Other standards or specifications
EN1494:2000+A1:2008	-

8. Done at: Saitama, Japan  
9. Date: 1 December, 2009

*Ryoichi Hiraki*  
Ryoichi Hiraki  
President of RIKENKAKI CO., LTD.  
President of CHANGZHOU RIKENSEIKO  
MACHINERY CO., LTD.

Note: This declaration becomes invalid, if technical or operational modifications are introduced without the manufacturers consent.

<p><b>Deutsch (German)</b> EG-Konformitätserklärung 1. Der Unterzeichner, Herr Ryoichi Hiraki, Vertreter der Hersteller, erklärt hiermit, das die unten beschriebenen Maschinen den relevanten Bestimmungen von folgender Richtlinie entsprechen: •EG-Richtlinie 2006/42/EC für Maschinen 2. Beschreibung der Maschine a) Allgemeine Bezeichnung : Scherenwagenheber b) Funktion : Anhebung des Kraftfahrzeugs c) Modell d) Typ 3. Hersteller (1) 4. Hersteller (2) 5. Juristische Person, die bevollmächtigt ist, die technische Datei zu erstellen 6. Bezug auf Standardübereinstimmungen 7. Andere Standards oder Spezifikationen 8. Ausgestellt in 9. Datum</p>	<p><b>Français (French)</b> Déclaration de conformité CE 1. Le soussigné, M. Ryoichi Hiraki, représentant es fabricants, déclare par présente que les machines décrites ci-dessous satisfont toutes les dispositions pertinentes de: •La Directive CE 2006/42/EC concernant les machines 2. Descriptor des machines a) Dénomination générique : Cric pantographe b) Fonction : evage de véhicule à moteur c) Modèle d) Type 3. Fabricant (1) 4. Fabricant (2) 5. Personne morale habilitée à compiler le fichier technique 6. Références aux normes harmonisées 7. Autres normes ou spécifications 8. Fait à 9. Date</p>
<p><b>Nederland (Dutch)</b> EG-conformiteitsverklaring 1. De ondergetekende, dhr. Ryoichi Hiraki, die de fabrikanten vertegenwoordigt, verklaart hierbij dat de hieronder beschreven machine voldoet aan alle relevante voorzieningen van: •De EG-richtlijn 2006/42/EG voor machines 2. Beschrijving van de machine a) Generieke benaming : Pantograafkrik b) Functie : Motorvoertuig opheffen c) Model d) Type 3. Fabrikant (1) 4. Fabrikant (2) 5. Rechtspersoon geautoriseerd voor de samenstelling van het technische dossier 6. Referentie geharmoniseerde normen 7. Andere normen of specificaties 8. Plaats 9. Datum</p>	<p><b>Dansk (Danish)</b> EF-overensstemmelseserklæring 1. Undertegnede, hr. Ryoichi Hiraki, som repræsenterer producenterne, erklærer hermed, at de herunder beskrevne maskiner overholder alle de relevante bestemmelser i: •Maskindirektivet, EU-direktiv 2006/42/EF 2. Beskrivelse af maskinerne a) Generisk betegnelse : Saksedonkraft b) Funktion : Til at løfte motorkøretøj c) Model d) Type 3. Producent (1) 4. Producent (2) 5. Juridisk person med bemyndigelse til det udarbejde den tekniske fil 6. Henviisninger til harmoniserede standarder 7. Andre standarder eller specifikationer 8. Sted 9. Dato</p>



<p><b>Italiano (Italian)</b> Dichiarazione CE di Conformità 1. Il sottoscritto, Sig. Ryoichi Hiraki, rappresentante delle fabbriche, dichiara che il veicolo sotto riportato è conforme alle disposizioni pertinenti alla: •Direttiva 2006/42/CE relative agli autoveicoli 2. Descrizione della vettura a) Denominazione generica : Martinetto a pantografo b) Funzione : sollevamento veicolo a motore c) Modello d) Tipo 3. Fabbrica (1) 4. Fabbrica (2) 5. Legale autorizzato a costituire il fascicolo tecnico 6. Riferimento norme standard 7. Altre norme e specifiche 8. Eseguito a 9. Data</p>	<p><b>Ελληνικά (Greek)</b> Δήλωση Συμμόρφωσης ΕΚ 1. Ο υπογεγραμμένος, κ. Ryoichi Hiraki, ως εκπρόσωπος των κατασκευαστών, δηλώνει δια του παρόντος ότι το μηχανήμα που περιγράφεται παρακάτω πληροί όλες τις σχετικές διατάξεις της: •Κοινοτικής Οδηγίας 2006/42/ΕΚ σχετική με μηχανήματα 2. Περιγραφή του μηχανήματος α) Συνήθης ονομασία : Γρύλος αυτοκινήτου β) Λειτουργία : Ανύψωση μηχανοκίνητων οχημάτων γ) Μοντέλο δ) Τύπος 3. Κατασκευαστής (1) 4. Κατασκευαστής (2) 5. Νομικό πρόσωπο εξουσιοδοτημένο για τη σύνταξη του τεχνικού φακέλου 6. Αναφορές στα εναρμονισμένα πρότυπα 7. Άλλα πρότυπα ή προδιαγραφές 8. Συντάχθηκε στη 9. Ημερομηνία</p>	<p><b>Suomi / Suomen kieli (Finnish)</b> EY Vaatimustenmukaisuusvakuutus 1. Allekirjoittanut, Mr. Ryoichi Hiraki, valmistajan edustaja, vakuuttaa täten, että alla kuvattu laite täyttää kaikki seuraavissa säännöksissä annetut asianmukaiset velvoitteet: •Koneita koskeva EY-direktiivi 2006/42/EC 2. Laitteen kuvaus a) Yleisnimike : Saksinosturi b) Käyttötarkoitus : moottoriajoneuvon nostaminen c) Malli d) Tyyppi 3. Valmistaja (1) 4. Valmistaja (2) 5. Teknisen tiedoston kokoamisoon valtuutettu oikeushenkilö 6. Yhdenmukaistettujen standardien viitetiedot 7. Muut standardit tai tiedot 8. Paikka 9. Päiväys</p>	<p><b>Čeština (Czech)</b> ES - Prohlášení o shodě 1. Niže podepsaný Ryoichi Hiraki jako zástupce výrobce, tímto prohlašuje, že uvedené strojní zařízení splňuje příslušné požadavky Směrnice evropské komise 2006/42/EC pro strojní zařízení. 2. Popis strojního zařízení a) Obecný název : nůžkový zvedák b) Funkce : zvedání motorových vozidel c) Model d) Typ 3. Výrobce (1) 4. Výrobce (2) 5. Právnícká osoba oprávněná k předložení technické dokumentace 6. Odkazy na harmonizované normy 7. Jiné normy nebo specifikace 8. Místo 9. Datum</p>
<p><b>Português (Portuguese)</b> Declaração de Conformidade CE 1. O abaixo-assinado, Ryoichi Hiraki, representando os fabricantes através desta, declara que a maquinaria descrita abaixo cumpre todas as disposições referentes à: •Directiva 2006/42/CE, sobre máquinas. 2. Descrição da maquinaria a) Denominação genérica : Macaco de tesoura b) Função : Elevação de veículo motor c) Modelo d) Tipo 3. Fabricante (1) 4. Fabricante (2) 5. Pessoa jurídica autorizada a compilar o processo técnico 6. Referências às normas harmonizadas 7. Outras normas ou especificações 8. Elaborado em 9. Data</p>	<p><b>Svenska (Swedish)</b> EG-försäkran om överensstämmelse 1. Undertecknad representant för tillverkaren, Mr. Ryoichi Hiraki, försäkrar härmed att den nedan beskrivna maskinutrustningen uppfyller alla tillämpliga bestämmelser i: •EU:s maskindirektiv 2006/42/EG 2. Beskrivning av maskinutrustningen a) Generisk benämning : Sackdomkraft b) Funktion : Lyft av motorfordon c) Modell d) Typ 3. Tillverkare (1) 4. Tillverkare (2) 5. Juridisk person behörig att sammanställa den tekniska dokumentationen 6. Hänvisningar till harmoniserade normer 7. Övriga normer eller specifikationer 8. Utförd i 9. Datum</p>	<p><b>Polski (Polish)</b> Deklaracja zgodności WE 1. Niżej podpisany, Pan Ryoichi Hiraki, reprezentujący producentów, niniejszym oświadcza, że opisane poniżej urządzenie jest zgodne z wszystkimi stosownymi postanowieniami: •Dyrektywy maszynowej Wspólnoty Europejskiej 2006/42/WE 2. Opis urządzenia a) Nazwa ogólna : podnośnik nożycowy b) Przeznaczenie : podnoszenie pojazdów silnikowych c) Model d) Typ 3. Producent (1) 4. Producent (2) 5. Osoba prawna upoważniona do kompilacji dokumentacji technicznej 6. Odniesienie do zharmonizowanych norm 7. Inne normy lub specyfikacje 8. Sporządzono w 9. Data</p>	<p><b>Slovenčina (Slovak)</b> ES vyhlásenie o zhode 1. Podpísaný Ryoichi Hiraki, zástupca výrobcov, týmto vyhlasuje, že nižšie opísané strojové zariadenie spĺňa všetky príslušné ustanovenia tejto smernice: •Smernica 2006/42/ES o strojových zariadeniach 2. Opis strojového zariadenia a) Generické určenie : pantografický zdvihák b) Funkcia : zdvíhanie motorových vozidiel c) Model d) Typ 3. Výrobca (1) 4. Výrobca (2) 5. Autorizovaný zástupca schopný predložiť technickú dokumentáciu 6. Odkazy na harmonizované normy 7. Iné normy alebo požiadavky 8. Miesto 9. Dátum</p>

<p><b>Magyar (Hungarian)</b> EK megfelelési nyilatkozat</p> <p>1. Alulírott, Mr. Ryoichi Hiraki, a gyártók képviselőiben ezennel kijelenti, hogy az alább megnevezett gép teljesíti: •a gépekre vonatkozó 2006/42/EK irányelv összes vonatkozó előírását:</p> <p>2. A gép leírása a) Általános megnevezés : olós emelő b) Rendeltetés : gépkocsiemelő c) Modell d) Típus 3. Gyártó (1) 4. Gyártó (2) 5. A műszaki dokumentáció összeállítására meghatalmazott jogi személy 6. Harmonizált szabványhivatkozások 7. Egyéb szabványok vagy műszaki jellemzők 8. Kiállítás helye 9. Kiállítás dátuma</p>	<p><b>Eesti (Estonian)</b> EÜ vastavuseklaratsioon</p> <p>1. Tootjate esindaja hr. Ryoichi Hiraki kinnitab käesolevaga, et allpool kirjeldatud seadmed vastavad järgmise õigusakti kõigile asjakohastele sätetele: •EÜ masinadirektiiv 2006/42/EÜ</p> <p>2. Seadmete kirjeldus a) Üldnimetus : käätungraud b) Funktsioon : mootorsõiduki töstmise c) Mudel d) Tüüp 3. Tootja (1) 4. Tootja (2) 5. Juriidiline isik, kes on volitatud koostama tehnilist toimetut 6. Viited harmoneeritud standarditele 7. Muud standardid ja spetsifikatsioonid 8. Koht 9. Kuupäev</p>	<p><b>Български (Bulgarian)</b> ЕС декларация за съответствие</p> <p>1. Допълнителният г-н Рьоичи Хираки, представляващ производителите, декларирам с настоящата, че машината описана по-долу напълно изпълнява всички съответни разпоредби на: •Европейската директивата 2006/42/ЕС за машиностроенето</p> <p>2. Описание на машината a) Генерично наименование : Пантографен крик b) Функция : повдигане на моторни превозни средства c) Модел d) Тип 3. Производител (1) 4. Производител (2) 5. Юридическо лице упълномощено да състави техническия файл 6. Препратки към хармонизирани стандарти 7. Други стандарти или спецификации 8. Изготвено в 9. Дата</p>	<p><b>Român (Romanian)</b> Declaratie de conformitate CE</p> <p>1. Subsemnatul Ryoichi Hiraki, reprezentant al producătorilor, declar prin prezenta că utilajul descris mai jos respectă toate prevederile relevante ale: •Directivei CE 2006/42/CE referitoare la mașini</p> <p>2. Descrierea utilajului a) Denumire generică : Cric tip pantograf b) Funcție : ridicarea vehiculelor cu motor c) Model d) Tip 3. Producător (1) 4. Producător (2) 5. Persoana juridică autorizată să redacteze fișierul tehnic 6. Trimiteri la standardele armonizate 7. Alte standarde sau specificații 8. Intocmită în 9. Data</p>
<p><b>Latviešu (Latvian)</b> EK paziņojums par atbilstību</p> <p>1. Zemāk parakstījis Ryoichi Hiraki, kas pārstāv ražotājus, ar šo paziņo, ka zemāk aprakstītā mašīna atbilst piemērojamām šīs direktīvas prasībām: •EK Mašīnu direktīva 2006/42/EK</p> <p>2. Mašīnas apraksts a) Vispārīgs apzīmējums : Vītnes domkrats b) Funkcija : Spēkratu celšana c) Modelis d) Tips 3. Ražotājs (1) 4. Ražotājs (2) 5. Juridiskā persona, kas pilnvarota apkopot tehnisko failu 6. Atsauces uz harmonizētajiem standartiem 7. Citi standarti vai specifikācijas 8. Vieta 9. Laiks</p>	<p><b>Slovensčina (Slovenian)</b> Izjava o skladnosti ES</p> <p>1. Podpisani g. Ryoichi Hiraki, ki zastopa proizvajalce, s tem izjavlja, da naprava, ki je opisana spodaj, izpolnjuje vse relevantne določbe: •Direktive o napravah 2006/42/ES</p> <p>2. Opis naprave a) Generično ime : Pantografski dvigalnik b) Funkcija : dvigovanje motornega vozila c) Model d) Tip 3. Proizvajalec (1) 4. Proizvajalec (2) 5. Pravna oseba, ki je upravičena do sestave tehničnega dokumenta 6. Reference glede harmoniziranih standardov 7. Drugi standardi ali specifikacije 8. Ustvarjeno v/na 9. Datum</p>	<p><b>Türk (Turkish)</b> AT Uygunluk Beyanı</p> <p>1. Aşağıda imzası bulunan Sn. Ryoichi Hiraki, imalatçıları temsilen, tarif edilen makinelerin aşağıda adı geçen yönetmeliğin ilgili hükümlerine uygun olduğunu beyan eder: •AT makine direktifi 2006/42/EC</p> <p>2. Makinelerin tanımı a) Jenerik adı : Pantograf krikko b) İşlevi : motorlu taşıtları kaldırma c) Model d) Tür 3. İmalatçı (1) 4. İmalatçı (2) 5. Teknik dosyayı düzenlemeye yetkili tüzel kişi 6. Uyumlulaştırılmış standartlara atıflar 7. Diğer standartlar ya da şartnameler 8. Düzenlendiği yer 9. Tarih</p>	<p><b>Íslenska (Icelandic)</b> EB-samræmisýfirlýsing</p> <p>1. Undirritaður, herra Ryoichi Hiraki, fulltrúi framleiðanda, lýsir yfir að vélbúnaðinum, sem lýst er hér að neðan, uppfyllir öll viðeigandi ákvæði: •EB-tilskipunarinnar 2006/42/EC um vélbúnað</p> <p>2. Lýsing á vélbúnaðinum a) Almennt heiti : Tviarma tjakkur b) Hlutverk : að lyfta vélknúnum ökutækjum c) Gerð d) Tegund 3. Framleiðandi (1) 4. Framleiðandi (2) 5. Lögaðili sem hefur heimild að taka saman tækniskjal 6. Tilvísanir í samhæfða staðla 7. Aðrir staðlar eða tæknilysingar 8. Staður 9. Dagsetning</p>

<p><b>Español (Spanish)</b> Declaración de Conformidad CE</p> <p>1. El abajo firmante, Sr. Ryoichi Hiraki, en representación de los fabricantes, por la presente declara que la maquinaria descrita a continuación cumple con las disposiciones aplicables de:</p> <p>•La directiva 2006/42/CE relativa a maquinarias</p> <p>2. Descripción de la maquinaria</p> <p>a) Denominación genérica : Gato pantográfico</p> <p>b) Función : Elevación de vehículo automotor</p> <p>c) Modelo d) Tipo</p> <p>3. Fabricante (1)</p> <p>4. Fabricante (2)</p> <p>5. Persona jurídica autorizada para recopilar el archivo técnico</p> <p>6. Referencias de normas armonizadas</p> <p>7. Otras normas o especificaciones</p> <p>8. Elaborada en 9. Fecha</p>	<p><b>Norsk (Norwegian)</b> EF-samsvarserklæring</p> <p>1. Undertegnede, Ryoichi Hiraki, som representere produsentene, erklærer herved at maskinen beskrevet nedenfor oppfyller alle relevante bestemmelser i:</p> <p>•EU-maskindirektiv 2006/42/EU</p> <p>2. Beskrivelse av maskineriet</p> <p>a) Generisk tегnelse : Pantografjekk (biljekk)</p> <p>b) Funksjon: løfting av motorkjøretøyer</p> <p>c) Modell d) Type</p> <p>3. Produsent(1)</p> <p>4. Produsent(2)</p> <p>5. Juridisk person med fullmakt til å utarbeide de tekniske dokumentasjonen</p> <p>6. Henvisninger til harmoniserte standarder</p> <p>7. Andre standarder eller spesifikasjoner</p> <p>8. Utarbeidet 9. Dato</p>
<p><b>Lietuvių kalba (Lithuanian)</b> EB atitikties deklaracija</p> <p>1. Toliau pasirašęs gamintojų atstovas Ryoichi Hiraki deklaruoja, kad toliau aprašytoji įranga atitinka visas atitinkamas nuostatas, išdėstytas:</p> <p>•EB Direktyvoje 2006/42/EB dėl mašinų</p> <p>2. Įrangos aprašymas</p> <p>a) Bendras pavadinimas : pantografo kėliklis</p> <p>b) Funkcija : motorinės transporto priemonės kėlimas</p> <p>c) Modelis d) Tipas</p> <p>3. Gamintojas (1)</p> <p>4. Gamintojas (2)</p> <p>5. Juridinis asmuo, įgaliotas sudaryti techninę bylą</p> <p>6. Nuoroda į tygiaverčius standartus</p> <p>7. Kiti standartai arba specifikacijos</p> <p>8. Atliktas 9. Data</p>	<p><b>Hrvatski (Croatian)</b> Izjava o sukladnosti EK</p> <p>1. Ja, dolje potpisani Ryoichi Hiraki, predstavnik proizvođača, ovime izjavljujem da su strojevi opisani u nastavku sukladni s bitnim odredbama:</p> <p>•Direktive 2006/42/EZ Europskog parlamenta i vijeća o strojevima</p> <p>2. Opis stroja</p> <p>a) Generički raziv : pantografska dizalica</p> <p>b) Funkcija : podizanje motornog vozila</p> <p>c) Model d) Tip</p> <p>3. Proizvođač (1)</p> <p>4. Proizvođač (2)</p> <p>5. Pravna osoba ovlaštena za sastavljanje tehničke dokumentacije</p> <p>6. Upućivanje na usklađene norme</p> <p>7. Ostale norme ili specifikacije</p> <p>8. Mjesto 9. Datum</p>

## Numbers

7-Speed Manual Shift Mode ..... 506

## A

ABS (Anti-lock Brake System)..... 639

ACC (Adaptive Cruise Control)..... 593

Accelerator Position Meter ..... 168

Accessories and Modifications ..... 738

Accessory Power Socket ..... 259

Adaptive Cruise Control (ACC)..... 593

Adaptive Cruise Control (ACC) and  
Intelligent Speed Limiter Set Speed  
Indicator ..... 125

Adaptive Cruise Control (ACC) with  
Low Speed Follow..... 129, 576

Adaptive Damper System..... 528

Button ..... 528

Adaptive Damper System Indicator..... 117

### Adding

Coolant ..... 694

Engine Oil..... 693

Washer..... 701

Additives, Engine Oil ..... 687

Adjustable Speed Limiter ..... 533

### Adjusting

Armrest ..... 251

Front Head Restraints..... 246

Front Seats ..... 243

Mirrors ..... 240

Rear Seats..... 250

Steering Wheel..... 239

Temperature ..... 165

Adjusting the Sound ..... 295, 337

Agile Handling Assist ..... 547

Aha™..... 357

Air Conditioning System (Climate  
Control System) ..... 275

Changing the Mode..... 278

Defrosting the Windscreen and  
Windows..... 279

Dust and Pollen Filter..... 730

Recirculation/Fresh Air Mode..... 278

Sensors ..... 282

Using Automatic Climate Control..... 275

Air Conditioning System (Heating System)

Defrosting the Windscreen and  
Windows..... 272

Dust and Pollen Filter..... 730

Sensors ..... 274

Using Automatic Heating ..... 270

Air Pressure..... 806

Airbags ..... 58

After a Collision ..... 61

Airbag Care..... 70

Event Data Recorder..... 1

Front Airbags (SRS)..... 60

Indicator..... 69, 115

Passenger Airbag Off Indicator ..... 70

Sensors ..... 58

Side Airbag ..... 65

Side Curtain Airbag ..... 67

AM/FM Radio ..... 297, 344

Android Auto ..... 376

Anti-lock Brake System (ABS)..... 639

Indicator ..... 114

Apple CarPlay..... 373

Armrest..... 251

Audio Remote Controls ..... 288

Audio System ..... 284

Adjusting the Sound ..... 295, 337

Audio/Information Screen ..... 291, 316

Changing the Home Screen Icon Layout.. 320

Changing the Screen Interface ..... 334

Closing Apps ..... 336

Customizing the Meter ..... 320

Display Setup ..... 296, 338

Error Messages ..... 380

General Information..... 382

HDMI™ Port..... 287

Home Screen ..... 326

iPod ..... 306, 350

Limitations for Manual Operation..... 339

Menu Customize ..... 335

MP3/WMA/AAC ..... 309, 358

Reactivating ..... 287

Recommended Devices ..... 382, 383

Remote Controls..... 288

Security Code ..... 287

Selecting an Audio Source ..... 339

Status Area ..... 333

Theft Protection ..... 287

USB Flash Drives..... 382

USB Port(s).....	285
Wallpaper Setup .....	293, 324
Audio/Information Screen .....	291, 316
Auto Door Locking/Unlocking .....	203
Auto High-Beam .....	230
Auto High-Beam Indicator.....	120
Auto Idle Stop .....	514, 520
OFF Button .....	515
Auto Idle Stop Indicator (Green) .....	124
Auto Idle Stop System Indicator (Amber).....	124
Automatic Brake Hold .....	636
Indicator .....	636
Automatic Lighting.....	225
Average Fuel Economy .....	164
Average Speed .....	164

## B

<b>Battery</b> .....	722
Charging System Indicator .....	112, 782
Jump Starting .....	772
Maintenance (Checking the Battery) .....	722
Maintenance (Replacing).....	724, 727
<b>Belts (Seat)</b> .....	46
<b>Beverage Holders</b> .....	257
<b>Blind spot information Indicator</b> .....	134
<b>Blind spot information System</b> .....	556
<b>Bluetooth® Audio</b> .....	312, 361
<b>Booster Seats (For Children)</b> .....	102

<b>Brake System</b> .....	633
Anti-lock Brake System (ABS).....	639
Automatic Brake Hold .....	636
Brake Assist System .....	640
Fluid .....	699
Foot Brake .....	635
Indicator .....	108
Parking Brake .....	633
<b>Braking Pressure Meter</b> .....	168
<b>Brightness Control (Instrument Panel)</b> ....	237
<b>Built-in Key</b> .....	189
<b>Bulb Replacement</b> .....	702
Back-Up Light.....	706
Brake Lights.....	706
Ceiling Light .....	709
Front Fog Lights.....	702
Front Turn Signal, Position/Daytime Running Lights.....	702
Glove Box Light .....	709
Headlights .....	702
High-Mount Brake Light .....	707
Interior Lights .....	709
Luggage Area Light .....	710
Map Light.....	708
Rear Licence Plate Light .....	707
Rear Turn Signal Light.....	706
Side Marker Lights.....	703
Side Turn Signal/Emergency Indicator Lights .....	705
Taillights .....	707
Taillights and Rear Fog Light .....	707

Vanity Mirror Lights.....	709
<b>Bulb Specifications</b> .....	805

## C

<b>Carbon Monoxide Gas</b> .....	104
<b>Carrying Luggage</b> .....	485, 487
<b>Certification Label</b> .....	808
<b>Changing Bulbs</b> .....	702
<b>Charging System Indicator</b> .....	112, 782
<b>Child Restraint System</b> .....	74
Booster Seats .....	102
Child Restraint System for Infants .....	77
Child Restraint System for Small Children ..	79
Installing a Child Restraint System with a Lap/Shoulder Seat Belt.....	96
Larger Children .....	101
Rear-facing Child Restraint System .....	77
Selecting a Child Restraint System .....	80
Using Tether.....	98
<b>Child Safety</b> .....	74
Childproof Door Locks.....	202
<b>Cleaning the Exterior</b> .....	735
<b>Cleaning the Interior</b> .....	732

- Climate Control System ..... 275
    - Changing the Mode ..... 275
    - Defrosting the Windscreen and Windows ..... 279
    - Dust and Pollen Filter ..... 730
    - Recirculation/Fresh Air Mode ..... 278
    - Sensors ..... 282
    - Using Automatic Climate Control ..... 275
  - Clock ..... 186
  - Coat Hooks ..... 263
  - Collision Mitigation Braking System (CMBS) ..... 565
  - Compact Spare Tyre ..... 744, 806
  - Console Compartment ..... 255
  - Continuously Variable Transmission ..... 501
    - Creeping ..... 501
    - Fluid ..... 698
    - Kickdown ..... 501
    - Operating the Shift
      - Lever ..... 29, 502, 503, 504, 505
      - Shift Lever Does Not Move ..... 776
      - Shifting ..... 502, 504
  - Controls ..... 185
  - Coolant (Engine) ..... 694
    - Adding to the Radiator ..... 696
    - Adding to the Reserve Tank ..... 694
    - Overheating ..... 779
  - Creeping (Continuously Variable Transmission) ..... 501
  - Cross Traffic Monitor ..... 648
  - Cruise Control ..... 529
  - Cup Holders ..... 257
  - Customized Features ..... 171, 388, 396
- D**
- DAB ..... 303, 347
  - Daytime Running Lights ..... 229
  - Dead Battery ..... 772
  - Defaulting All the Settings ..... 429
  - Deflation Warning System ..... 549, 553
    - Indicator ..... 118, 119
    - Initialise ..... 550, 553
  - Defrosting the Windscreen and Windows ..... 279
  - Devices that Emit Radio Waves ..... 811
  - Dimming
    - Headlights ..... 224
    - Rearview Mirror ..... 240
  - Dipstick (Engine Oil) ..... 690
  - Directional Signals (Turn Signal) ..... 223
  - Display Setup ..... 296, 338
  - Display/Information Button ..... 161, 316
  - Door Mirrors ..... 241
  - Doors ..... 188
    - Auto Door Locking ..... 203
    - Auto Door Unlocking ..... 203
    - Door Open Indicator ..... 45
    - Keys ..... 188
    - Locking/Unlocking the Doors from the Inside ..... 201
    - Locking/Unlocking the Doors from the Outside ..... 191
  - Drive Mode Switch ..... 526
  - Driver Information Interface ..... 161
  - Driving ..... 483
    - Braking ..... 633
    - Continuously Variable Transmission ..... 501
    - Cruise Control ..... 529
    - Shifting Gear ..... 502, 504, 509
    - Starting the Engine ..... 493, 496
  - Dust and Pollen Filter ..... 730
- E**
- EC Declaration of Conformity Content Outline ..... 824
  - Eco Assist System ..... 11
  - ECON Mode ..... 513
  - Elapsed Time ..... 164
  - Electric Power Steering (EPS) System ..... 786
    - Indicator ..... 117, 786
  - Emergency ..... 797
  - Emergency Stop Signal ..... 641
  - Engine ..... 808
    - Coolant ..... 694
    - Jump Starting ..... 772
    - Oil ..... 687
    - Starting ..... 493, 496
    - Switch Buzzer ..... 218
  - Engine Coolant ..... 694
    - Adding to the Radiator ..... 696

Adding to the Reserve Tank .....	694
Overheating.....	779
<b>Engine Oil</b> .....	687
Adding .....	693
Checking .....	690
Low Oil Level Indicator .....	789
Low Oil Pressure Indicator .....	111, 782
Recommended Engine Oil.....	687
<b>Engine Start/Stop Button</b> .....	219
<b>EPS (Electric Power Steering)</b>	
System.....	117, 786
<b>Exhaust Hazard (Carbon Monoxide)</b> .....	104
<b>Exterior Care (Cleaning)</b> .....	735
<b>Exterior Mirrors</b> .....	241
<b>F</b>	
<b>Features</b> .....	283
<b>Filter</b>	
Dust and Pollen.....	730
<b>Flat Tyre</b> .....	744
<b>Fluids</b>	
Brake/Clutch .....	699
Continuously Variable Transmission .....	698
Engine Coolant .....	694
Manual Transmission .....	698
Windscreen Washer.....	701
<b>FM/AM Radio</b> .....	297, 344
<b>Folding Down the Rear Seats</b> .....	250
<b>Foot Brake</b> .....	635
<b>Front Airbags (SRS)</b> .....	60

<b>Front Fog Light Indicator</b> .....	121
<b>Front Head Restraints</b> .....	246
<b>Front Seat Heaters</b> .....	268
<b>Front Seats</b> .....	243
Adjusting.....	243
<b>Front Sensor Camera</b> .....	630
<b>Fuel</b> .....	655
Fuel Economy and CO <sub>2</sub> Emissions .....	659
Gauge .....	159
Instant Fuel Economy.....	164
Low Fuel Indicator .....	114
Range.....	164
Recommendation .....	655
Refueling.....	655
<b>Fuel Economy and CO<sub>2</sub> Emissions</b> .....	659
<b>Fuel Fill Door</b> .....	31, 657
<b>Fuses</b> .....	790
Inspecting and Changing.....	796
Locations.....	790
<b>G</b>	
<b>Gauges</b> .....	159
<b>Gear Shift Lever Positions</b>	
Continuously Variable	
Transmission.....	502, 504
Manual Transmission .....	509
<b>Glass (care)</b> .....	736
<b>Glove Box</b> .....	254
<b>G-Meter</b> .....	168

## H

### Hands-Free Telephone System

<b>(HFT)</b> .....	430, 451
Automatic Import of Cellular	
Phonebook and Call History.....	444, 464
Displaying Messages.....	478
HFT Buttons .....	430, 451
HFT Menus.....	432, 454
HFT Status Display .....	431, 453
Limitations for Manual Operation....	431, 453
Making a Call.....	447, 472
Options During a Call.....	450, 475
Phone Setup.....	436, 459
Phonebook Phonetic Modification.....	468
Receiving a Call.....	449, 475
Receiving a Text/E-mail Message.....	476
Ring Tone.....	442, 463
Selecting a Text/E-mail Message	
Account .....	477
Speed Dial.....	445, 465
To Set Up Text/E-mail Message Options...	462
<b>Hatch</b> .....	204
Light Bulb.....	710
Release Lever.....	801
Unable to Open.....	801
<b>Hazard Warning Button</b> .....	4, 5
<b>HDMI™ Port</b> .....	287
<b>Headlight Washers</b> .....	236

<b>Headlights</b> .....	224	Adaptive Cruise Control (ACC) and Intelligent Speed Limiter Set Speed .....	125	M (7-speed manual shift mode) Indicator/ Shift .....	112
Aiming .....	702	Adaptive Cruise Control (ACC) with Low Speed Follow .....	129, 576	Malfunction Indicator Lamp .....	111
Automatic Operation .....	225	Adaptive Damper System .....	117	Parking Brake and Brake System .....	108
Dimming .....	224, 229	Auto High-Beam .....	120	Parking Brake and Brake System (Amber) .....	110
Operating .....	224	Auto Idle Stop (Green).....	124	Passenger Front Airbag On/Off.....	115
Washer .....	236	Auto Idle Stop System (Amber).....	124	Rear Fog Light.....	121
<b>Heated Door Mirrors</b> .....	238	Automatic Brake Hold .....	636	Road Departure Mitigation.....	126, 128
<b>Heaters</b> .....	268	Blind spot information .....	134	Seat Belt Reminder.....	114
<b>Heating System</b> .....	270	Charging System .....	112	Security System Alarm.....	123
Defrosting the Windscreen and Windows .....	272	Collision Mitigation Braking System (CMBS).....	131	Shift Down .....	112
Dust and Pollen Filter .....	730	Cruise Control .....	530	Shift Lever Position.....	112
Heating .....	270	Cruise Main.....	529, 530	Shift Up .....	112
<b>HFT (Hands-Free Telephone   System)</b> .....	430, 451	Deflation Warning System .....	119	Speed Limiter .....	125
<b>High Beam Indicator</b> .....	121	Drive Mode .....	123	Supplemental Restraint System .....	115
<b>Honda Sensing</b> .....	562	ECON Mode.....	123	System Message .....	120
<b>Honda TRK</b> .....	755	EPS (Electric Power Steering) System.....	117	Transmission System .....	112
<b>I</b>		Front Fog Light .....	121	Turn Signal and Hazard Warning.....	121
<b>Identification Numbers</b> .....	808	Gear Position.....	113	VSA (Vehicle Stability Assist) system .....	116
Engine and Transmission.....	808	High Beam .....	121	VSA OFF .....	117, 545
Vehicle Identification .....	808	Immobilizer System .....	122	<b>Instrument Panel</b> .....	107
<b>Ignition Switch</b> .....	218	Intelligent Speed Limiter .....	125	Brightness Control .....	237
<b>Illumination Control</b> .....	237	Lane Keeping Assist System (LKAS) ..	130, 611	<b>Intelligent Speed Limiter</b> .....	537
Knob .....	237	Lights On .....	121	<b>Intelligent Speed Limiter Indicator</b> .....	125
<b>Immobilizer System</b> .....	207	Low Fuel .....	114	<b>Interior Lights</b> .....	252
Indicator .....	122	Low Oil Pressure.....	111	<b>Interior Rearview Mirror</b> .....	240
<b>Indicators</b> .....	108	Low Tyre Pressure/Deflation Warning System .....	118	<b>iPod</b> .....	306, 350
ABS (Anti-lock Brake System) .....	114				



## J

Jack (Wheel Nut Wrench).....	750
Jump Starting.....	772

## K

Key Number Tag.....	190
Keys.....	188
Number Tag.....	190
Rear Door Won't Open.....	202
Remote Transmitter.....	197
Types and Functions.....	188
Won't Turn.....	36
Kickdown (Continuously Variable Transmission).....	501

## L

Lane Keeping Assist System (LKAS).....	609
LaneWatch™.....	559
Language (HFT).....	453
Lights.....	224, 702
Automatic.....	225
Bulb Replacement.....	702
Daytime Running Lights.....	229
Fog Lights.....	227
High Beam Indicator Light.....	121
Interior.....	252
Light Switches.....	224
Lights On Indicator.....	121
Turn Signals.....	223

Limited Slip Differential (LSD).....	548
Load Limits.....	487
Locking/Unlocking.....	188
Auto Door Locking/Unlocking.....	203
Childproof Door Locks.....	202
From Inside.....	201
From Outside.....	191
Keys.....	188
Using a Key.....	199
Low Battery Charge.....	782
Low Fuel Indicator.....	114
Low Oil Level Symbol.....	789
Low Oil Pressure Indicator.....	782
Lower Anchorages.....	91
Lubricant Specifications Chart.....	805
Luggage (Load Limit).....	487
Luggage Area Cover.....	266
Luggage Hook.....	265

## M

M (7-speed manual shift mode)	
Indicator/Shift Indicator.....	112
Maintenance.....	661
Battery.....	722
Brake/Clutch Fluid.....	699
Cleaning.....	732
Climate Control.....	729
Coolant.....	694
Heating System.....	729
Oil.....	690

Oil Monitor System.....	670
Precautions.....	662
Radiator.....	696
Remote Transmitter.....	727
Replacing Light Bulbs.....	702
Safety.....	663
Service Reminder System.....	665
Transmission Fluid.....	698
Tyres.....	716
Under the Bonnet.....	682
Malfunction Indicator Lamp.....	111, 783
Manual Transmission.....	509
Map Lights.....	253
Maximum Permissible Weight.....	487
Meters, Gauges.....	159
Mirrors.....	240
Adjusting.....	240
Door.....	241
Exterior.....	241
Interior Rearview.....	240
Modifications (and Accessories).....	738
MP3.....	309, 358
Multi-View Rear Camera.....	653

## N

Numbers (Identification).....	808
-------------------------------	-----

## O

Odometer.....	163
---------------	-----

Oil (Engine) .....	687	Passenger Airbag Off Indicator .....	70	Refueling .....	655
Adding .....	693	Passing Indicators .....	224	Fuel Gauge .....	159
Checking .....	690	Petrol .....	31, 655	Low Fuel Indicator .....	114
Low Oil Level Indicator .....	789	Fuel Economy and CO <sub>2</sub> Emissions .....	659	Petrol .....	655, 804
Low Oil Pressure Indicator .....	111, 782	Gauge .....	159	<b>Regulations</b> .....	811
Oil Monitor System .....	670	Information .....	655	<b>Remote Transmitter</b> .....	197
Recommended Engine Oil .....	687	Instant Fuel Economy .....	164	<b>Replacement</b>	
Viscosity .....	687	Low Fuel Indicator .....	114	Battery .....	724, 727
<b>Oil Monitor System</b> .....	670	Refueling .....	655	Bulbs .....	702
<b>On Board Apps</b> .....	365	<b>Playing Bluetooth® Audio</b> .....	312, 361	Fuses .....	790
<b>Open Source Licences</b> .....	386	<b>Pop-up Hood System</b> .....	71	Tyres .....	744
<b>Opening</b>		Pop-up Hood System Care .....	73	Wiper Blade Rubber .....	711, 714
Hatch .....	801	<b>Precautions While Driving</b> .....	499	<b>Resetting a Trip Meter</b> .....	164
<b>Opening/Closing</b>		Rain .....	501	<b>Rev Indicators</b> .....	168
Bonnet .....	685	<b>Pregnant Women</b> .....	55	<b>Rev Match System</b> .....	511
Hatch .....	204	<b>Puncture (Tyre)</b> .....	744	<b>Road Departure Mitigation</b> .....	617
Power Windows .....	212			On and Off .....	620
Sunroof .....	216				
<b>Outside Temperature Display</b> .....	165				
<b>Overheating</b> .....	779				
<b>P</b>		<b>R</b>		<b>S</b>	
<b>Paddle Shifters (7-Speed Manual Shift Mode)</b> .....	506, 507	<b>Radar Sensor</b> .....	632	<b>Safe Driving</b> .....	41
<b>Parking Brake</b> .....	633	<b>Radiator</b> .....	696	<b>Safety Check</b> .....	45
<b>Parking Brake and Brake System Indicator</b> .....	108	<b>Radio (FM/AM)</b> .....	297, 344	<b>Safety Labels</b> .....	105
<b>Parking Brake and Brake System Indicator (Amber)</b> .....	110	<b>Radio Data System (RDS)</b> .....	298, 346	<b>Safety Message</b> .....	0
<b>Parking Sensor System</b> .....	644	<b>RDS (Radio Data System)</b> .....	298, 346	<b>Seat Belts</b> .....	46
		<b>Rear Demister/Heated Door Mirror Button</b> .....	238	Adjusting the Shoulder Anchor .....	54
		<b>Rear Fog Light Indicator</b> .....	121	Checking .....	56
		<b>Rear Seat Heaters</b> .....	269	Fastening .....	52
		<b>Rear Seats (Folding Down)</b> .....	250	Installing a Child Restraint System with a Lap/Shoulder Seat Belt .....	96
		<b>Rearview Mirror</b> .....	240	Pregnant Women .....	55

Reminder .....	49	Specifications .....	804	<b>Towing a Trailer</b> .....	488
Warning Indicator .....	49, 114	Specified Fuel .....	655	Equipment and Accessories .....	490
<b>Seats</b> .....	243	Speed Limiter, Adjustable .....	533	Load Limits .....	488
Adjusting .....	243	Speed Limiter, Intelligent .....	537	<b>Towing Your Vehicle</b>	
Front Seat Heaters .....	268	Speedometer .....	159	Emergency .....	797
Front Seats .....	243	SRS Airbags (Airbags) .....	60	<b>Traffic Sign Recognition System</b> .....	623
Rear Seats .....	250	<b>Start/Stop Button</b> .....	219	Small Icons On and Off .....	629
<b>Security System</b> .....	207	<b>Starting the Engine</b> .....	493, 496	<b>Transmission</b> .....	502, 504, 509
Immobilizer System Indicator .....	122	Does Not Start .....	768	7-Speed Manual Shift Mode .....	506
Security System Alarm Indicator .....	123	Engine Switch Buzzer .....	218	Continuously Variable	
<b>Select Lever</b> .....	502, 504	Jump Starting .....	772	Transmission .....	502, 504
Operation .....	502, 504	<b>Steering Wheel</b> .....	239	Fluid .....	698
Releasing .....	776	Adjusting .....	239	Gear Position Indicator .....	112
Won't Move .....	776	<b>Stopping</b> .....	642	Manual .....	509
<b>Selecting a Child Restraint System</b> .....	80	<b>Stopwatch</b> .....	169	Number .....	808
<b>Selector Knob (Audio)</b> .....	290	<b>Super Locking</b> .....	211	Shift Lever Position Indicator .....	112, 503, 505
<b>Service Reminder System</b> .....	665	<b>Supplemental Restraint System (SRS)</b> .....	60	<b>Trip Knob</b> .....	163
<b>Setting the Clock</b> .....	186	<b>Switches (Around the Steering</b>		<b>Trip Meter</b> .....	163
<b>Shift Lever</b> .....	502, 504, 509	Wheel) .....	4, 5, 6, 218	<b>TRK (Temporary Repair Kit)</b> .....	755
<b>Shift Lever Position Indicator</b> ..	112, 503, 505	<b>System Message Indicator</b> .....	120	<b>Troubleshooting</b> .....	741
<b>Shift Up Backlight/Shift Up Alarm</b> .....	160	<b>T</b>		Blown Fuse .....	790
<b>Shift Up/Down Indicators</b> .....	112, 508, 510	<b>Tachometer</b> .....	159	Brake Pedal Vibrates .....	36
<b>Shifting (Transmission)</b> .....	502, 504, 509	<b>Temperature</b>		Buzzer Sounds When Opening Door .....	38
<b>Shoulder Anchor</b> .....	54	Outside Temperature Display .....	165	Emergency Towing .....	797
<b>Side Airbags</b> .....	65	<b>Temperature Sensor</b> .....	165, 282	Engine Won't Start .....	768
<b>Side Curtain Airbag</b> .....	67	<b>Temporary Repair Kit (TRK)</b> .....	755	Noise When Braking .....	39
<b>Siri Eyes Free</b> .....	372	<b>Tie-down Anchors</b> .....	265	Overheating .....	779
<b>Smartphone Connection</b> .....	366	<b>Time (Setting)</b> .....	186	Puncture/Flat Tyre .....	744
<b>Song By Voice™ (SBV)</b> .....	353	<b>Tools</b> .....	742	Rear Door Won't Open .....	37
<b>Spare Tyre</b> .....	744, 806			Select Lever Won't Move .....	776
<b>Spark Plugs</b> .....	804			Warning Indicators .....	108

<b>Turbo Engine Vehicle</b> .....	660
<b>Turn Signals</b> .....	223
Indicators (Instrument Panel).....	121
<b>Tyres</b> .....	716
Air Pressure .....	806
Checking and Maintaining.....	716
Inspection.....	716
Puncture (Flat Tyre).....	744
Rotation .....	719
Spare Tyre .....	744, 806
Temporary Repair Kit (TRK) .....	755
Tyre Chains.....	720
Wear Indicators .....	717
Winter.....	720

## U

Ultrasonic Sensors.....	210
Unlocking the Doors.....	191
Unlocking the Front Doors from the Inside .....	201
USB Flash Drives.....	309, 358, 382
USB Port(s).....	285

## V

Vanity Mirrors.....	9
Vehicle Identification Numbers .....	808
Vehicle Stability Assist (VSA).....	544
OFF Indicator .....	117
Off Switch .....	545

System Indicator.....	116
<b>Viscosity (Oil)</b> .....	687, 805
<b>Voice Control Operation</b> .....	340
Audio Commands .....	342
Climate Control Commands.....	343
General Commands .....	343
Music Search Commands .....	343
On Screen Commands.....	343
Phone Commands.....	342
Useful Commands.....	342
Voice Portal Screen.....	341
Voice Recognition .....	340
<b>VSA (Vehicle Stability Assist)</b> .....	544

## W

Wallpaper .....	293, 324
Warning and Information Message .....	135
Warning Indicator On/Blinking .....	782
Warning Labels.....	105
Watts.....	805
Wear Indicators (Tyre).....	717
Wheel Nut Wrench (Jack Handle) .....	750
Wi-Fi Connection .....	370
Window Washers .....	233
Adding/Refilling Fluid .....	701
Switch.....	233
Windows (Opening and Closing) .....	212
Windscreen .....	233
Cleaning .....	736
Defrosting/Defogging.....	279

Washer Fluid.....	701
Wiper Blades.....	711
Wipers and Washers .....	233
<b>Winter Tyres</b> .....	720
Tyre Chains.....	720
<b>Wipers and Washers</b> .....	233
Checking and Replacing Wiper Blades.....	711
Front.....	233
Rear .....	235
<b>Wireless Charger</b> .....	260
<b>WMA</b> .....	309, 358
<b>Worn Tyres</b> .....	716